



AGENDA

BOARD OF SUPERVISORS, COUNTY OF MONO STATE OF CALIFORNIA

Regular Meetings: First, Second, and Third Tuesday of each month. Location of meeting is specified below.
Teleconference Only - No Physical Location

Regular Meeting January 18, 2022

TELECONFERENCE INFORMATION

This meeting will be held via teleconferencing with members of the Board attending from separate remote locations. As authorized by AB 361, dated September 16, 2021, a local agency may use teleconferencing without complying with the teleconferencing requirements imposed by the Ralph M. Brown Act when a legislative body of a local agency holds a meeting during a declared state of emergency and local officials have recommended or imposed measures to promote social distancing or the body cannot meet safely in person and the legislative body has made such findings.

Members of the public may participate via the Zoom Webinar, including listening to the meeting and providing public comment, by following the instructions below. If you are unable to join the Zoom Webinar of the Board meeting, you may still view the live stream of the meeting by visiting
http://monocounty.granicus.com/MediaPlayer.php?publish_id=fd043961-041d-4251-a6e8-803b439caa17

To join the meeting by computer:

Visit <https://monocounty.zoom.us/j/86055796605>

Or visit <https://www.zoom.us/>, click on "Join A Meeting" and enter the Zoom Webinar ID 860 5579 6605.

To provide public comment, press the "Raise Hand" button on your screen.

To join the meeting by telephone:

Dial (669) 900-6833, then enter Zoom Webinar ID 860 5579 6605.

To provide public comment, press *9 to raise your hand and *6 to mute/unmute.

NOTE: In compliance with the Americans with Disabilities Act, if you need special assistance to participate in this meeting, please contact the Clerk of the Board at (760) 932-5530 or bos@mono.ca.gov. Notification 48 hours prior to the meeting will enable the County to make reasonable arrangements to ensure accessibility to this meeting (See 42 USCS 12132, 28CFR 35.130).

Full agenda packets are available for the public to review in the Office of the Clerk of the Board (Annex I - 74 North School Street, Bridgeport, CA 93517) and online at <http://monocounty.ca.gov/bos>. Any writing distributed less than 72 hours prior to the meeting will be available for public inspection in the Office of the Clerk of the Board and online.

UNLESS OTHERWISE SPECIFIED BY TIME, ITEMS SCHEDULED FOR EITHER THE MORNING OR AFTERNOON SESSIONS WILL BE HEARD ACCORDING TO AVAILABLE TIME AND PRESENCE OF INTERESTED PERSONS. PUBLIC MAY COMMENT ON AGENDA ITEMS AT THE TIME THE ITEM IS HEARD.

9:00 AM Call meeting to Order

Pledge of Allegiance

1. OPPORTUNITY FOR THE PUBLIC TO ADDRESS THE BOARD

Opportunity for the public to address the Board on items of public interest that are within the subject matter jurisdiction of the Board. (Speakers may be limited in speaking time dependent upon the press of business and number of persons wishing to address the Board.) Please refer to the Teleconference Information section to determine how to make public comment for this meeting via Zoom.

2. RECOGNITIONS - NONE

3. COUNTY ADMINISTRATIVE OFFICER

CAO Report regarding Board Assignments
Receive brief oral report by County Administrative Officer (CAO) regarding work activities.

4. DEPARTMENT/COMMISSION REPORTS

Receive brief oral report on emerging issues and/or activities.

5. CONSENT AGENDA

(All matters on the consent agenda are to be approved on one motion unless a board member requests separate action on a specific item.)

A. Board Minutes

Approval of the Board Minutes from the December 2021 meetings.

Recommended Action:

- 1) Approve the Board Minutes from the Regular Meeting on December 7, 2021.
- 2) Approve the Board Minutes from the Regular Meeting on December 14, 2021.

Fiscal Impact: None.

B. Contract for Legal Services - Indigent Defense

Departments: CAO

Proposed contract with attorney Josh Hillemeier pertaining to the provision of indigent defense services for Mono County.

Recommended Action: Approve contract with attorney Josh Hillemeier to provide public defender services in Mono County for a period of two years commencing March 21, 2022, and ending March 20, 2024, and authorize Chair to execute said contracts on behalf of the County. Provide any desired direction to staff.

Fiscal Impact: Not-to-exceed amount of \$180,000 annually, commencing in 2022, with 2% automatic annual increases.

C. Mono County Lactation Policy

Departments: County Counsel

Proposed resolution adopting a Lactation Accommodation Policy and Request Form and amending Mono County's Personnel Rules applicable to all employee bargaining units to add Section 345 "Lactation Accommodation."

Recommended Action: Adopt proposed resolution. Provide any desired direction to staff.

Fiscal Impact: At the Board's direction, the proposed policy would provide paid break time for lactation purposes of up to 30 minutes (as opposed to the State law required 15 minutes of paid time) when taken in conjunction with an employee's regularly-scheduled break time.

D. Prop 68 Grant Application for Mountain Gate Park

Departments: Public Works

Proposed resolution Approving the Application for Rural Recreation and Tourism Program Grant Funds.

Recommended Action: Adopt proposed resolution. Provide any desired direction to staff.

Fiscal Impact: No match is required for this project/location. The County has sufficient internal borrowing capacity to provide cash flow for construction of the project as grant reimbursements from the state are periodically received. Future operating and maintenance costs are considered minimal, if any.

6. CORRESPONDENCE RECEIVED

Direction may be given to staff regarding, and/or the Board may discuss, any item of correspondence listed on the agenda.

A. Governor's Proclamation of the June 7, 2022 Statewide Direct Primary Election

Departments: Elections

(Scheereen Dedman) - A proclamation by the Governor of the State of California that the Statewide Direct Primary Election will be held throughout the state on Tuesday, June 7, 2022.

B. Letter from Range of Light Group concerning Withdrawal from OVGA and Fish Slough Wetland

A letter from the Sierra Club Toiyabe Chapter Range of Light Group discussing

concerns over the Fish Slough wetland should Mono County withdraw from the Owens Valley Groundwater Authority (OVGA) Joint Powers Agreement.

7. REGULAR AGENDA - MORNING

A. COVID-19 (Coronavirus) Update

Departments: CAO, Public Health
15 minutes

(Robert C. Lawton, CAO, Bryan Wheeler, Public Health Director, Dr. Caryn Slack, Public Health Officer) - Update on Countywide response and planning related to the COVID-19 pandemic.

Recommended Action: None, informational only.

Fiscal Impact: None.

B. Justice, Equity, Diversity, and Inclusion (JEDI) Update

Departments: JEDI
10 minutes

(Scheereen Dedman, JEDI Coordinator) - Update on the proposed Justice, Equity, Diversity, and Inclusion (JEDI) training plan.

Recommended Action: None, informational only.

Fiscal Impact: None.

C. Workshop - County Retiree Health Care Obligation

Departments: Finance
1 hour 15 minutes (45 minutes presentation, 30 minutes questions and discussion)

(Janet Dutcher, Finance Director) - Workshop providing information about the County's Retiree Health Care program, the resulting obligation, status of assets accumulated to pay future retiree health care costs, budgetary impacts, and review of funding policy options.

Recommended Action: Receive presentation. Discuss future funding policy options. Provide desired direction to staff.

Fiscal Impact: The County's 2021-22 adopted budget includes appropriations of \$1,764,000 to pay retiree health care costs. The County's liability at June 30, 2021 was \$8,241,779, after reduction of \$22,670,568 for accumulated fiduciary trust assets. Explicit future annual retiree health care costs are projected to average \$1,770,419 over the next 15 years, after which annual costs will gradually decline to near \$0 over the next fifty years.

D. Letter to the Board of Forestry and Fire Protection Regarding the 2021

State Minimum Fire Safe Regulations

Departments: Community Development

20 minutes

(Wendy Sugimura, Community Development Director) - Proposed comment letter to the Board of Forestry and Fire Protection (BOF) regarding the November 22 Draft of the State Minimum Fire Safe Regulations. The BOF initiated a 15-day comment period on January 3 and written comments are due Wednesday January 19, 2022.

Recommended Action: 1) Review and discuss draft comment letter, provide direction to staff regarding revisions to the finalization of the letter; 2) Approve with any desired modifications and authorize the Chair to sign; 3) Direct staff to submit the approved letter by January 19 deadline.

Fiscal Impact: None.

E. Amendment to Deputy Probation Officers MOU

Departments: Probation

15 minutes

(Karin Humiston, Chief Probation Officer) - Proposed resolution amending the Memorandum of Understanding (MOU) between the County and the Deputy Probation Officers' Association to add Special Assignment Pay for Officers providing Batterers' Intervention Services.

Recommended Action: Adopt resolution amending MOU with Deputy Probation Officers Association to add a provision establishing five percent (5%) special assignment pay for up to three certified officers assigned as Batterers Intervention facilitators.

Fiscal Impact: Fiscal impact for the proposed Probation MOU change to add five percent (5%) batterer's intervention enhanced pay, annually would be \$14,087 which includes \$10,103 for salary and \$3,984 for benefits. This assumes three officers qualify for the pay for an entire year. The additional costs would be funded by the SB 678 revenues. No fiscal impact to the general fund.

F. Request for Letter of Commitment for Project Homekey Grant Application for Mammoth Lakes Housing

Departments: CAO

15 minutes

(Robert C. Lawton) - Request for a letter of commitment to a Project Homekey grant application for Mammoth Lakes Housing to the State of California. If successful, this project will result in the creation of 14 housing units in Mammoth Lakes, to be owned and operated by Mammoth Lakes Housing. The grant application requires up to a \$1.2m in a local match, currently anticipated as up to a \$700,000 contribution from the Town of Mammoth Lakes and this request for a

commitment of up to a \$500,000 contribution from the County.

Recommended Action: Board Decision. Provide any desired direction to staff.

Fiscal Impact: Mammoth Lakes Housing is requesting a commitment of up to \$500,000 to combine with up to \$700,000 from the Town of Mammoth Lakes for a total of up to \$1,200,000 in local funding to be matched by the State on a one-to-one basis.

8. OPPORTUNITY FOR THE PUBLIC TO ADDRESS THE BOARD

Opportunity for the public to address the Board on items of public interest that are within the subject matter jurisdiction of the Board. (Speakers may be limited in speaking time dependent upon the press of business and number of persons wishing to address the Board.) Please refer to the Teleconference Information section to determine how to make public comment for this meeting via Zoom.

9. CLOSED SESSION

A. Closed Session - Labor Negotiations

CONFERENCE WITH LABOR NEGOTIATORS. Government Code Section 54957.6. Agency designated representative(s): Bob Lawton, Stacey Simon, Janet Dutcher, Anne Frievalt, Ryan Roe, and Oliver Yee. Employee Organization(s): Mono County Sheriff's Officers Association (aka Deputy Sheriff's Association), Local 39 - majority representative of Mono County Public Employees (MCPE) and Deputy Probation Officers Unit (DPOU), Mono County Paramedic Rescue Association (PARA), Mono County Public Safety Officers Association (PSO). Unrepresented employees: All.

B. Closed Session - Existing Litigation

CONFERENCE WITH LEGAL COUNSEL – EXISTING LITIGATION. Paragraph (1) of subdivision (d) of Government Code section 54956.9. Name of case: *Shroeder Muniz v. County of Mono et al.* (DFEH Case No. 202108-14595527).

C. Closed Session - Public Employee Evaluation

PUBLIC EMPLOYEE PERFORMANCE EVALUATION. Government Code section 54957. Title: County Administrative Officer.

10. BOARD MEMBER REPORTS

The Board may, if time permits, take Board Reports at any time during the meeting and not at a specific time.

ADJOURN



OFFICE OF THE CLERK
OF THE BOARD OF SUPERVISORS

REGULAR AGENDA REQUEST

Print

MEETING DATE January 18, 2022

TIME REQUIRED

SUBJECT Board Minutes

**PERSONS
APPEARING
BEFORE THE
BOARD**

AGENDA DESCRIPTION:

(A brief general description of what the Board will hear, discuss, consider, or act upon)

Approval of the Board Minutes from the December 2021 meetings.

RECOMMENDED ACTION:

- 1) Approve the Board Minutes from the Regular Meeting on December 7, 2021.
- 2) Approve the Board Minutes from the Regular Meeting on December 14, 2021.

FISCAL IMPACT:

None.

CONTACT NAME: Queenie Barnard

PHONE/EMAIL: 7609325534 / qbarnard@mono.ca.gov

SEND COPIES TO:

MINUTE ORDER REQUESTED:

YES NO

ATTACHMENTS:

Click to download

[DRAFT December 7, 2021 Minutes](#)

[DRAFT December 14, 2021 Minutes](#)

History

Time	Who	Approval
1/12/2022 3:54 PM	County Counsel	Yes
1/6/2022 8:59 AM	Finance	Yes

1/14/2022 3:15 PM

County Administrative Office

Yes



**DRAFT MEETING MINUTES
BOARD OF SUPERVISORS, COUNTY OF MONO
STATE OF CALIFORNIA**

Regular Meetings: First, Second, and Third Tuesday of each month. Location of meeting is specified below.

Teleconference Only - No Physical Location

**Regular Meeting
December 7, 2021**

Backup Recording	Zoom
Minute Orders	M21-255 – M21-260
Resolutions	R21-81
Ordinance	ORD21-13 Not Used

9:00 AM Meeting Called to Order by Chair Kreitz.

Supervisors Present: Corless, Duggan, Gardner, Kreitz, and Peters (all attended via teleconference).

Supervisors Absent: None.

The Mono County Board of Supervisors stream most of their meetings live on the internet and archives them afterward. To search for a meeting from June 2, 2015 forward, please go to the following link: <http://www.monocounty.ca.gov/meetings>.

Pledge of Allegiance led by Supervisor Corless.

1. OPPORTUNITY FOR THE PUBLIC TO ADDRESS THE BOARD

None.

2. RECOGNITIONS - NONE

3. COUNTY ADMINISTRATIVE OFFICER

CAO Report regarding Board Assignments

Bob Lawton, CAO:

- Met in Jail Project with County Executive Coordination team
- Interviews for Assistant to County Administrator
- Attended CSAC Annual meeting in Monterey
- Emergency EOC meeting to discuss recent outbreaks, followed up with meeting

Note:

These draft meeting minutes have not yet been approved by the Mono County Board of Supervisors

- with local businesses
- Organize for collective bargaining discussions
- Participated in discussion with colleagues from Inyo and Alpine counties on developing a comprehensive economic development strategy
- Workplace Wellbeing – employee newsletter, Coffee with the CAO
- NACo Finance, Pension, and Intergovernmental Affairs Steering Committee

4. DEPARTMENT/COMMISSION REPORTS

Nate Greenberg, IT Director:

- Redistricting update – website has a new button with direct link to new application providing side-by-side analysis of six alternative maps

Tony Dublino, Director of Public Works:

- Roads Division – recreation on Virginia Lakes Road
- Application for Saddlebag Lake Road project
- Solid Waste – negotiations complete with proposers, agendized for December 21

Justin Nalder, Solid Waste Superintendent:

- ESJPA – representative for Mono County on ad hoc limited term legislative committee

5. CONSENT AGENDA

(All matters on the consent agenda are to be approved on one motion unless a board member requests separate action on a specific item.)

A. Board Minutes

Departments: Clerk of the Board

Approval of the Board Minutes from the October and November 2021 meetings.

Action:

- 1) Approve the Board Minutes from the Regular Meeting on October 19, 2021.
- 2) Approve the Board Minutes from the Regular Meeting on November 2, 2021.
- 3) Approve the Board Minutes from the Special Meeting on November 8, 2021.
- 4) Approve the Board Minutes from the Regular Meeting on November 9, 2021.

Gardner motion. Corless seconded.

Vote: 5 yes, 0 no

M21-255

Note:

These draft meeting minutes have not yet been approved by the Mono County Board of Supervisors

B. Monthly Treasury Transaction Report

Departments: Finance

Treasury Transaction Report for the month ending 10/31/2021.

Action: Approve the Treasury Transaction Report for the month ending 10/31/2021.

Gardner motion. Corless seconded.

Vote: 5 yes, 0 no

M21-256

C. Reappointment - Economic Development, Tourism & Film Commission

Departments: Economic Development

Reappointment of Sarah Walsh (District 3) to the Mono County Economic Development, Tourism & Film Commission (EDTFC) for a 4-year term ending November 22, 2025.

Action: Reappoint Sarah Walsh to the Mono County Economic Development, Tourism & Film Commission for a four-year term from November 22, 2021 to November 22, 2025.

Gardner motion. Corless seconded.

Vote: 5 yes, 0 no

M21-257

D. Women, Infants and Children (WIC) Contract Amendment

Departments: Public Health

Proposed Standard Agreement Amendment with California Department of Public Health (CDPH) Women, Infants, and Children (WIC) Program pertaining to Contract #19-10162, A02.

Action: Approve County entry into proposed contract amendment and authorize Board Chair to execute said contract on behalf of the County by signing one (1) copy of Standard Agreement Amendment (STD 213A).

Gardner motion. Corless seconded.

Vote: 5 yes, 0 no

M21-258

E. Summary Road Vacation – Excess Right-of-Way Abutting Paradise

Note:

These draft meeting minutes have not yet been approved by the Mono County Board of Supervisors

Shores and Highway 182

Departments: Public Works

Proposed resolution Summary Road Vacation – Excess Right-of-Way Abutting Paradise Shores and Highway 182.

Action:

- 1) Adopt Resolution No. R21-81, “A Resolution of the Mono County Board of Supervisors for Summary Vacation of Excess Right-of-Way Abutting Paradise Shores and Highway 182 in Bridgeport, Ca.”; and,
- 2) Direct the Clerk of the Board to record a certified copy of the fully executed Resolution with the County Recorder; and,
- 3) Find that the above action is categorically exempt from the California Environmental Quality Act (CEQA) pursuant to 14 CCR §15305 as a Class 1 Exemption for “Existing Facilities” and direct the County Engineer to file a Notice of Exemption for the project consistent with 14 CCR §15062.

Gardner motion. Duggan seconded.

Vote: 4 yes, 0 no, 1 abstain

R21-81

Supervisor Peters:

- Own property adjacent to Paradise Shores Report and will be abstaining from vote

F. Mono County Child Care Council Amended Bylaws

Departments: Mono County Child Care Council

The Board of Supervisors is required by law to remain involved in the processes and procedures of the local child care and development planning council (Mono County Child Care Council). As part of its involvement, the Board appoints members to the Council and reviews the Council's By-Laws. The Council has recently amended its By-laws to reflect recent changes in law and is seeking Board review and approval of those amendments.

Action: Approve amended Mono County Child Care Council Bylaws.

Gardner motion. Corless seconded.

Vote: 5 yes, 0 no

M21-259

6. CORRESPONDENCE RECEIVED

Direction may be given to staff regarding, and/or the Board may discuss, any item of correspondence listed on the agenda.

Note:

These draft meeting minutes have not yet been approved by the Mono County Board of Supervisors

The Board acknowledged receipt of the correspondence.

A. Letter from Josh Rhodes Acknowledging Public Works Employee John Hauter

A letter from Mono County resident Josh Rhodes acknowledging Public Works employee John Hauter for his work at the Chalfant and Benton Parks.

Supervisor Duggan:

- Thanked John Hauter and his team for their work

Supervisor Corless:

- Thanks to John and other members of facilities team

B. Letter from California Department of Child Support Services Regarding System Outages

A letter from California Department of Child Support Services regarding system outages causing online resources commonly used by the courts and the local child support agencies to be intermittently unavailable.

C. Application for Alcoholic Beverage License - Rhino's Bar and Grill

An application to the State of California Department of Alcoholic Beverage Control for Alcoholic Beverage License by S. KEYSER COMPANY doing business as RHINO'S BAR & GRILL located at 226 MAIN ST, BRIDGEPORT, CA 93517.

D. Letter from California Governor's Office of Emergency Services (Cal OES) Regarding Mono County's California Disaster Assistance Act Request

California Governor's Office of Emergency Services (Cal OES) response letter regarding Mono County's request for financial assistance from the California Disaster Assistance Act for the Mountain View Fire.

Supervisor Peters:

- Thank you to everyone involved

E. Letter from Lee Vining Chamber of Commerce to Regional Forester Eberlien Regarding 2021 Forest Closures

A letter from the Lee Vining Chamber of Commerce to Regional Forester Eberlien regarding the September 2021 forest closures.

Supervisor Corless:

- This has come up in regional groups – CSAC, RCRC. Suggestion that we develop a plan/suggested proposal for handling forest closures and work with region

Note:

These draft meeting minutes have not yet been approved by the Mono County Board of Supervisors

7. REGULAR AGENDA - MORNING

A. Mono County Film Commission and Inyo National Forest Collaboration Regarding Special Use Permit Process for Filming

Departments: Economic Development

(Alicia Vennos, Economic Development Director/Film Commissioner; Inyo National Forest - Sheila Irons, Forest Lands Officer and Travis Mason, Assistant Public Services Staff Officer (on detail)) - Report regarding filming production in Mono County, the current capacity issues faced by the Inyo National Forest, and proposed collaborative solution.

Action: None.

Jeff Simpson, Economic Development Manager:

- Presented item

Supervisor Gardner:

- Pursue trial period, possibly set up cost share

Travis Mason, Assistant Public Services Staff Officer:

- Vacant positions – funding and difficulty recruiting

Sheila Irons, Forest Lands Officer:

- Fees – filming is one of the few with fee retention, most other fees go to treasury. Land Use fees and cost recovery fees for processing and monitoring

Supervisor Corless:

- Support 6 month trial, but encourage County to approach Film Permitting and Special Use Permits in general as an Economic Development function and not place the burden on already overburdened Inyo National Forest staff

Supervisor Peters:

- As this pilot program develops, have conversation about Humboldt-Toiyabe and how we can potentially accelerate the opportunities for more special use permits, especially winter recreation

Chair Kreitz:

- Emphasize support for looking into cost sharing

B. Housing Policy and Programs: Discussion, Prioritization, and Summary

Departments: Community Development

(Bentley Regehr, Planning Analyst; Wendy Sugimura, Community Development Director) - Discuss and prioritize housing policies and programs, and review summary of programs.

Action: None.

Note:

These draft meeting minutes have not yet been approved by the Mono County Board of Supervisors

Wendy Sugimura, Community Development Director:

- Introduced item

Bentley Regehr, Planning Analyst:

- Walked through table and programs

Board direction – follow the staff recommendation contained within Staff Report Summary. Add to follow-up items: Board consider emergency declaration around state of housing and discussion on potential short term rental moratorium

Break 11:17 AM

Reconvened: 11:29 AM

C. COVID-19 (Coronavirus) Update

Departments: CAO, Public Health

(Robert C. Lawton, CAO, Bryan Wheeler, Public Health Director) - Update on Countywide response and planning related to the COVID-19 pandemic.

Action: None.

Bryan Wheeler, Public Health Director:

- Presentation (can be found under Supporting Documents on meeting webpage: <https://monocounty.ca.gov/bos/page/board-supervisors-134>)
- Spike in cases
- No indication new variant is in Mono County
- Breakthrough cases, boosters

Supervisor Corless:

- Feedback from constituent – thank you to Bryan and Assistant Director Burrows for information shared on social media
- Community update before holidays, signage posted

Public Comment:

- Wendy Sugimura – AYSO, thanks to Director Wheeler and Public Health staff

D. Mountain View Fire Update and Review of Emergency Declarations

Departments: Mountain View Fire Emergency Operations Center

(Justin Nalder, EOC Director) - Review of continuing need for Board of Supervisor's November 17, 2020, Declaration of Local Emergency of and Mono County Health Officer's November 19, 2020, Declaration of Local Health Emergency for the Mountain View Fire.

Action: Find that there is a need to continue the local state of emergency declared on November 17, 2020 and the local health emergency declared on November 19, 2020 (ratified by the Board on November 24, 2020) until more information is known regarding the remaining unremediated properties, despite the recently-received news from CalOES regarding the

Note:

These draft meeting minutes have not yet been approved by the Mono County Board of Supervisors

County's cost share.

Peters motion. Gardner seconded.

Vote: 5 yes, 0 no

M21-260

Justin Nalder, EOC Director:

- California Disaster Assistance Act – funded at 100% for disaster-related projects

Janet Dutcher, Finance Director:

- Clarified that State reimbursement at 100% is only for debris removal. Remainder of our costs (overtime, repairs and replacement done to guardrails, reconstruction of transfer station) is still being reimbursed at 25%.

8. OPPORTUNITY FOR THE PUBLIC TO ADDRESS THE BOARD

Janet Dutcher:

- Today is anniversary of Pearl Harbor. Request that the Board adjourn in memory of those who lost their lives on that day.

Moved to Item 10.

9. CLOSED SESSION

Closed Session: 12:27 PM

Reconvened: 2:53 PM

No action to report out of Closed Session.

A. Closed Session - Labor Negotiations

CONFERENCE WITH LABOR NEGOTIATORS. Government Code Section 54957.6. Agency designated representative(s): Bob Lawton, Stacey Simon, Janet Dutcher, Anne Frievalt, Ryan Roe, and Oliver Yee. Employee Organization(s): Mono County Sheriff's Officers Association (aka Deputy Sheriff's Association), Local 39 - majority representative of Mono County Public Employees (MCPE) and Deputy Probation Officers Unit (DPOU), Mono County Paramedic Rescue Association (PARA), Mono County Public Safety Officers Association (PSO). Unrepresented employees: All.

B. Closed Session - Existing Litigation

CONFERENCE WITH LEGAL COUNSEL - EXISTING LITIGATION. Paragraph (1) of subdivision (d) of Government Code section 54956.9. Name of case: Claim for damages filed by Jenna Lavender.

Note:

These draft meeting minutes have not yet been approved by the Mono County Board of Supervisors

C. Closed Session - Existing Litigation

CONFERENCE WITH LEGAL COUNSEL - EXISTING LITIGATION.
Paragraph (1) of subdivision (d) of Government Code section 54956.9.
Name of case: Claim for damages filed by Craig Balogh.

D. Closed Session - Existing Litigation

CONFERENCE WITH LEGAL COUNSEL – EXISTING LITIGATION.
Paragraph (1) of subdivision (d) of Government Code section 54956.9.
Name of case: *County of Mono v. K.R. Property Management, et al.* (Mono County Superior Court Case No.: CV200081).

E. Closed Session - Exposure to Litigation

CONFERENCE WITH LEGAL COUNSEL – ANTICIPATED LITIGATION.
Significant exposure to litigation pursuant to paragraph (2) of subdivision (d) of Government Code section 54956.9. Number of potential cases: one.

F. Closed Session - Public Employee Evaluation

PUBLIC EMPLOYEE PERFORMANCE EVALUATION. Government Code section 54957. Title: County Administrative Officer.

10. BOARD MEMBER REPORTS

Supervisor Corless:

- 11/18-19: California Wildfire and Forest Resilience Task Force Meeting and Caldor Fire Tour
- At meeting, reviewed current status of state's wildfire year and progress on action plan, with special focus on a plan to increase the use of prescribed fire, more info here: <https://fntf.fire.ca.gov/>. As member of task force executive committee, joined a tour of the Caldor Fire footprint, organized by the Tahoe Conservancy and led by Cal Fire and the El Dorado National Forest. There were many lessons learned that are applicable to Mono County; given the heightened interest in wildfire-related issues, suggest agendaing an update on the tour and task force in January.
- 11/29-12/2: CSAC Annual Meeting--congratulations to Supervisor Peters on his well-deserved recognition/award there.
- 12/6: Eastern Sierra Sustainable Recreation Partnership meeting. Noted that Supervisor Gardner and the Eastern Sierra Dispersed Camping Collaborative were nominated for a partnership award by US Forest Service Region 5, along with the Eastern Sierra Climate and Communities Resilience Project.

Supervisor Duggan:

- November 17 – attended Economic Development Tourism and Film Commission meeting. Highlight of meeting was importance of working with Forest Service on economic issues
- Also that evening, attended Tri-Valley Groundwater Management District meeting – reviewed the upcoming GSP
- November 18 – attended OVGA meeting, to review public comment and set deliverables for meeting on 12/9
- That evening, attended Long Valley RPAC meeting

Note:

These draft meeting minutes have not yet been approved by the Mono County Board of Supervisors

- November 23 – attended CSA #1 meeting, working with Public Works on upcoming recreation projects and community services enhancements. Thank you to Public Works for work with CSA #1 and other entities in community to help solve issue of timely mail delivery.
- November 29 – December 2 – attended CSAC Annual Meeting
- Yesterday, participated in radio call in program called Mondays with the Mayor

Supervisor Gardner:

- On Wednesday Nov. 17 I participated in a meeting of the June Lake Chamber of Commerce. Topics discussed included a beautification project at the balanced rock site and possible options for raising revenue for community projects.
- Last week I attended with my Board colleagues the California State Association of County Supervisors Annual Conference in Monterey. The conference had several excellent speakers on a variety of subjects.
- On Wednesday Dec. 1 I participated in the monthly meeting of the June Lake Citizens Advisory Committee. Topics discussed included redistricting, the County's Strategic Planning process, and options for locating an EV Charger in June Lake.
- On Thursday Dec. 2 I participated in another planning session for the Children's Summit to be held on July 13 of 2022.
- On Friday Dec. 3 I participated in the monthly meeting of the Kutzadika Tribal Council. Topics discussed included the status of Federal recognition of the Tribe, the process for tribal consultation for County projects and other matters, and updates on several ongoing tribal projects.
- Yesterday I attended a meeting of the NACO Public Lands Policy Committee and the Western Interstate Region Board. Topics discussed included an update on pending Congressional legislation, and other public lands issues.
- Also, yesterday I participated on the monthly meeting of the Eastern Sierra Sustainable Recreation Partnership. Topics discussed included the status of several grant opportunities and pending state and Federal initiatives.

Chair Kreitz:

- On November 18th I participated in the quarterly Mono County Treasury Oversight Committee meeting. The Committee approved the investment policy, which will be coming before the Board in January.
- The MLH Development and Program Committee met on Friday, November 19th to discuss the status of the Access Apartments.
- Monday, November 22nd I met with the CSAC Housing, Land-use, and Transportation Committee to review the final agenda for the CSAC Annual Conference.
- Tuesday, November 23, I met with Rural County Representatives of California (RCRC) to discuss their Golden State Finance Agency programs. They offer down payment assistance programs for households earning up to 160% AMI, some are forgivable, program works best with FHA lending since the highest percent down is 7%.
- Later Tuesday, the CoC Point-in-Time Count committee met. The January 2022 Count will take place the night of January 27th.
- Last week I attended the CSAC Annual Conference. My week started with a great business meeting and presentation for the Women's Leadership Forum. I also attended a workshop on how counties are spending their ARPA funds. Some counties are using surveys their communities to see how the public would like the funds to be spent. The funds may be spent on any CDBG eligible activity. The Housing, Land-use and Transportation Committee meeting included a discussion on priorities, the Infrastructure Investment and Jobs Act and the future of the gas

Note:

These draft meeting minutes have not yet been approved by the Mono County Board of Supervisors

tax and California transportation revenue trends. The CSAC Board approved a 3% increase in the annual dues structure at their Board meeting.

- Monday, December 6th, I attended the CCRH Legislative Committee meeting. We reviewed 15 activities that resulted from the CCRH Annual Housing Summit. The Committee used this meeting to make some further refinement and prioritization that will go to the full board for consideration on Friday.
- Later, I participated in the regular monthly Mammoth Lakes Housing board meeting. The Board approved a contract with RCAC to provide an additional \$16,000 in rental assistance. We received an update from MLH on IMACA's Valley Apartments which is causing severe financial strain on IMACA. The Board asked for more information prior to further consideration on some form of partnership.

Supervisor Peters:

- Today and tomorrow, will be participating on interview panel for Humboldt-Toiyabe Bridgeport District Ranger position
- Toiyabe Health Clinic in Bridgeport has hired an RN, expanding services
- IMACA controller position is open
- NACo committee meetings
- CSAC Annual Conference

Moved to Item 9.

ADJOURNED AT 2:53 PM in memory of those who lost their lives in the attack on Pearl Harbor.

ATTEST

**JENNIFER KREITZ
CHAIR OF THE BOARD**

**QUEENIE BARNARD
ASSISTANT CLERK OF THE BOARD**



**DRAFT MEETING MINUTES
BOARD OF SUPERVISORS, COUNTY OF MONO
STATE OF CALIFORNIA**

Regular Meetings: First, Second, and Third Tuesday of each month. Location of meeting is specified below.

Teleconference Only - No Physical Location

**Regular Meeting
December 14, 2021**

Backup Recording	Zoom
Minute Orders	M21-261 – M21-268
Resolutions	R21-82 – R21-86
Ordinance	ORD21-13 Not Used

9:02 AM Meeting Called to Order by Chair Kreitz.

Supervisors Present: Corless, Duggan, Gardner, Kreitz, and Peters (all attended via teleconference).

Supervisors Absent: None.

The Mono County Board of Supervisors stream most of their meetings live on the internet and archives them afterward. To search for a meeting from June 2, 2015 forward, please go to the following link: <http://www.monocounty.ca.gov/meetings>.

Pledge of Allegiance led by Supervisor Duggan.

1. OPPORTUNITY FOR THE PUBLIC TO ADDRESS THE BOARD

Eric Edgerton, Owner/Operator of Tilth Farms:

- Cannabis cultivation tax reform

2. RECOGNITIONS - NONE

3. COUNTY ADMINISTRATIVE OFFICER

CAO Report regarding Board Assignments

Bob Lawton, CAO:

- Due to inclement weather and uncertain state of road closures, advised department heads that they are authorized to provide services remotely today
- Meeting with Mammoth Lakes Town Manager Holler – discussed upcoming joint

Note:

These draft meeting minutes have not yet been approved by the Mono County Board of Supervisors

- Town Council / County meeting in January
- Mono County Workforce Wellbeing – restarting employee recognition system
- Collective bargaining negotiations are underway
- ESCOG
- Community Development Department changes
- Administered Oath of Office to two new employees – Stephanie Frank, LaVaree Chavez
- Working with County Counsel and Social Services on developing structure for Public Conservator, Public Authority and Public Guardian Services in county

4. DEPARTMENT/COMMISSION REPORTS

Justin Nalder, Solid Waste Superintendent:

- Mammoth Lakes Police Department and Mono County Sheriff's Department working on Christmas tree pick up program – Solid Waste Division has partnered with them to help accommodate
- Raising funds for their Explorer Program

Sheriff Braun:

- Explorer Program – opportunity for kids aged 14-18 to get involved and learn more about law enforcement
- Request for everyone to stay home, if possible, due to the snow

Nathan Reade, Agricultural Commissioner:

- Project that helps first responders when responding to an emergency that may involve pesticide use

5. CONSENT AGENDA

(All matters on the consent agenda are to be approved on one motion unless a board member requests separate action on a specific item.)

A. Resolution Authorizing Virtual Meetings under AB 361

Departments: County Counsel

Proposed resolution authorizing remote teleconference meetings for the period of December 14, 2021 through January 13, 2022, pursuant to AB 361.

Action: Adopt resolution R21-82, authorizing remote teleconference meetings for the period of December 14, 2021 through January 13, 2022, pursuant to AB 361.

Gardner motion. Peters seconded.

Vote: 5 yes, 0 no

R21-82

Note:

These draft meeting minutes have not yet been approved by the Mono County Board of Supervisors

B. Claim for Damages - Jenna Lavender

Departments: Risk Management

Claim for damages filed by Jenna Lavender, a misdirected claim related to a death at a hospital unaffiliated with the County of Mono.

Action: Deny the claim submitted by Jenna Lavender, and direct the Risk Manager, in consultation with County Counsel, to send notice to the claimant of the denial.

Gardner motion. Peters seconded.

Vote: 5 yes, 0 no

M21-261

C. Claim for Damages - Craig Balogh

Departments: Risk Management

Claim for damages filed by Craig Balogh, a misdirected claim related to a death at a hospital unaffiliated with the County of Mono.

Action: Deny the claim submitted by Craig Balogh, and direct the Risk Manager, in consultation with County Counsel, to send notice to the claimant of the denial.

Gardner motion. Peters seconded.

Vote: 5 yes, 0 no

M21-262

D. Contracts for Legal Services - Indigent Defense

Departments: CAO

Proposed contracts with Brad Braaten, Esq. and the Law Office of Sophie C. Bidet, Inc. pertaining to the provision of indigent defense services for Mono County.

Action: Approve contracts with the Law Office of Sophie C. Bidet and with attorney Brad Braaten to provide public defender services in Mono County for a period of five years commencing January 1, 2022, and ending December 31, 2026, and authorize Chair to execute said contracts on behalf of the County.

Gardner motion. Peters seconded.

Vote: 5 yes, 0 no

M21-263

Note:

These draft meeting minutes have not yet been approved by the Mono County Board of Supervisors

E. Contract for Investigator Services - Indigent Defense

Departments: CAO

Proposed contract with Brian H. Grice, dba Coast Criminal & Civil pertaining to the provision of investigator services.

Action: Approve, and authorize CAO to sign, contract with Brian H. Grice, dba Coast Criminal & Civil, for the provision of investigative services related to indigent defense and related matters for the period January 1, 2022, through December 31, 2026.

Gardner motion. Peters seconded.

Vote: 5 yes, 0 no

M21-264

6. CORRESPONDENCE RECEIVED - NONE

7. REGULAR AGENDA - MORNING

A. COVID-19 (Coronavirus) Update

Departments: CAO, Public Health

(Robert C. Lawton, CAO, Bryan Wheeler, Public Health Director) - Update on Countywide response and planning related to the COVID-19 pandemic.

Action: None.

Bryan Wheeler, Public Health Director:

- Presentation (can be found under Supporting Documents on meeting webpage: <https://monocounty.ca.gov/bos/page/board-supervisors-136>)

B. California Immunization Local Assistance Grant Amendment

Departments: Public Health

(Bryan Wheeler, Public Health Director) - Proposed Amendment to Grant Agreement Number 17-10332, A03 with the California Department of Public Health, Immunization Branch.

Action: Approve Amended Grant Agreement Number 17-10332, A03 and authorize the Chair of the Board of Supervisors to sign the amended contract on behalf of the County. Additionally, provide authorization for the Public Health Director to sign future amendments to the grant that shift funds between budget categories without changes to the grant allocation.

Gardner motion. Duggan seconded.

Vote: 5 yes, 0 no

Note:

These draft meeting minutes have not yet been approved by the Mono County Board of Supervisors

M21-265

Bryan Wheeler, Public Health Director:

- Presented item

C. Proposed Ordinance Adding Chapter 20.10 to the Mono County Code, Open Range, and Excluding Additional Portions of the County from Territory Devoted Chiefly to Grazing

Departments: Agricultural Commissioner

(Nathan D. Reade, Agricultural Commissioner) - Proposed ordinance adding Chapter 20.10, Open Range, to the Mono County Code consolidating the provisions of, and thereby replacing Ordinance Nos. 79-480, 79-480A and 87-480B and excluding additional areas of the County from territory devoted chiefly to grazing.

Action: Introduce, read title, and waive further reading of proposed ordinance.

Peters motion. Corless seconded.

Vote: 4 yes, 1 no

M21-266

Roll Call:

Corless - Y

Duggan - Y

Gardner - N

Kreitz - Y

Peters - Y

Nathan D. Reade, Agricultural Commissioner:

- Presented item

Public Comment:

- William Osborn
- Kris Leinassar, FIM
- Robert McMahon
- Grant Kowalchick
- George Mead

Christian Milovich, Assistant County Counsel:

- Addressed enforcement

Stacey Simon, County Counsel:

- Mono County is not involved in enforcement of these ordinances – this would be between the property owners and grazers

Nathan D. Reade, Agricultural Commissioner:

Note:

These draft meeting minutes have not yet been approved by the Mono County Board of Supervisors

- Addressed William Osborn's comment regarding stray animals

Break: 10:10 AM

Reconvened: 10:20 AM

D. Community Corrections Partnership (CCP) Realignment Implementation Plan

Departments: Probation

(Karin Humiston, Chief Probation Officer) - A resolution of the Mono County Board of Supervisors authorizing the Mono County Community Corrections Partnership Executive Committee to submit the Realignment Implementation Plan Annual Report for 2021 to the Board of State and Community Corrections.

Action: Adopt Resolution R21-83, authorizing the Mono County Community Corrections Partnership Executive Committee to submit the Realignment Implementation Plan Annual Report for 2021 (with the correction to the Table of Contents pagination) to the Board of State and Community Corrections.

Gardner motion. Duggan seconded.

Vote: 5 yes, 0 no

R21-83

Karin Humiston, Chief Probation Officer:

- Presented Realignment Implementation Plan Annual Report for 2021

Jeff Mills, Fiscal & Admin Services Officer:

- Reviewed Budget

Chair Kreitz

- Inmate Welfare Fund that came before the Board several months ago – encourage everyone to collaborate with funding and resources

E. Cal Recycle 1383 Model Ordinance

Departments: Solid Waste

(Justin Nalder, Solid Waste Superintendent) - Proposed ordinance implementing mandatory organic waste disposal reduction pursuant to Senate Bill 1383.

Action: Introduce, read title, and waive further reading of proposed ordinance.

Peters motion. Gardner seconded.

Vote: 5 yes, 0 no

M21-267

Note:

These draft meeting minutes have not yet been approved by the Mono County Board of Supervisors

Justin Nalder, Solid Waste Superintendent:

- Presented item

F. Budget Assumptions and Approach

Departments: CAO

(Robert C. Lawton, CAO) - This item is to review the transition of the Budget from a Finance function to a CAO function and any changes that will be made to the budget in the coming year.

Action: None.

Bob Lawton, CAO:

- Presented item

8. OPPORTUNITY FOR THE PUBLIC TO ADDRESS THE BOARD

None.

Moved to Item 12.

9. CLOSED SESSION

Closed Session: 11:58 AM

Reconvened: 1:00 PM

Reentered Closed Session: 1:39 PM

Reconvened: 2:31 PM

No action to report out of Closed Session.

A. Closed Session - Labor Negotiations

CONFERENCE WITH LABOR NEGOTIATORS. Government Code Section 54957.6. Agency designated representative(s): Bob Lawton, Stacey Simon, Janet Dutcher, Anne Frievault, Ryan Roe, and Oliver Yee. Employee Organization(s): Mono County Sheriff's Officers Association (aka Deputy Sheriff's Association), Local 39 - majority representative of Mono County Public Employees (MCPE) and Deputy Probation Officers Unit (DPOU), Mono County Paramedic Rescue Association (PARA), Mono County Public Safety Officers Association (PSO). Unrepresented employees: All.

B. Closed Session - Exposure to Litigation

Note:

These draft meeting minutes have not yet been approved by the Mono County Board of Supervisors

CONFERENCE WITH LEGAL COUNSEL – ANTICIPATED LITIGATION. Significant exposure to litigation pursuant to paragraph (2) of subdivision (d) of Government Code section 54956.9. Number of potential cases: two.

C. Closed Session - Public Employee Evaluation

PUBLIC EMPLOYEE PERFORMANCE EVALUATION. Government Code section 54957. Title: County Administrative Officer.

10. OPPORTUNITY FOR THE PUBLIC TO ADDRESS THE BOARD

None.

11. REGULAR AGENDA - AFTERNOON

A. Sale of Residential Housing Units in Benton to Utu Utu Gwaitu Tribe

Departments: CAO

(Stacey Simon, County Counsel; Erik Ramakrishnan, Attorney) - Proposed contract with Utu Utu Gwaitu Tribe pertaining to sale of two residential housing units located in Benton for continued use as affordable/tribal housing by the Tribe; related resolutions and findings.

Action:

- 1) Adopt Resolution R21-84, declaring the County-owned real property located at 36 to 40 Christie Lane in Benton is exempt surplus land for purposes of the Surplus Land Act; and
- 2) Adopt Resolution R21-85, approving a Purchase and Sale Agreement to sell the property to the Utu Utu Gwaitu Paiute Tribe of Benton; and
- 3) Find that the Board's actions with respect to the foregoing approvals are exempt from review under CEQA pursuant to CEQA Guidelines Sections 15061(b)(3) and 15301.
- 4) Direction to Finance Director to receive funds in Affordable Housing fund

Duggan motion. Corless seconded.

Vote: 5 yes, 0 no

R21-84, R21-85, M21-268

Stacey Simon, County Counsel:

- Introduced item

Erik Ramakrishnan:

- Presented item

Janet Dutcher, Finance Director:

- Asked Board to direct proceeds into Affordable Housing Fund

Note:

These draft meeting minutes have not yet been approved by the Mono County Board of Supervisors

B. Redistricting - Resolution Adopting Final Map Depicting New Supervisorial District Boundaries

Departments: CAO

(Robert C. Lawton, CAO) - Proposed resolution adopting new supervisorial district boundaries following and based upon the 2020 federal decennial census.

Action: Adopt Resolution R21-86, adopting new supervisorial district boundaries (Alternative Map 3) following and based upon the 2020 federal decennial census.

Kreitz motion. Corless seconded.

Vote: 4 yes, 1 no

R21-86

Roll Call:

Corless - Y

Duggan - Y

Gardner - N

Kreitz - Y

Peters - Y

Bob Lawton, CAO:

- Introduced item

Nate Greenberg, IT Director:

- Reviewed final six alternative maps
- Reviewed public input submissions

Chair Kreitz:

- Preference is Map 3

Supervisor Corless:

- Suggest eliminating maps 1B and 4B as they exceed the 10% population variance
- Community preference for Map 3 or 4A

Supervisor Duggan:

- Agree eliminating two maps that exceed 10% population variance
- Prefer Map 1A, second choice is Map 3

Supervisor Gardner:

- Expressed concern about increasing the percentage for the Latinx community
- Preference is Map 4A, second choice is Map 2, third choice is Map 1A

Supervisor Peters:

- Preference is Map 3

Note:

These draft meeting minutes have not yet been approved by the Mono County Board of Supervisors

12. BOARD MEMBER REPORTS

Supervisor Corless:

- 12/8 - Sustainable Recreation and Tourism Initiative Wrap-up Meeting: Detailed the final list of projects that emerged from this two-year process, more information at essrp.org
- 12/9 - RCRC/Golden State Finance and Golden State Connect Authority meetings: Chaired final day of meetings for RCRC and affiliate organizations, appreciate support and understand of colleagues in Mono County and hope that benefits of this extra effort are clear; meeting highlights include election of new 2nd Vice Chair, Chris Lopez/Monterey County; adding Santa Barbara County to RCRC's membership; approval of strategic plan (CEO Pat Blacklock can make a presentation to our board about the final plan in early 2022); approval of higher line of credit for revolving loan fund program that will soon be utilized by the Eastern Sierra Council of Governments; first meeting of the broadband-focused Golden State Connect Authority. Read more here: https://www.rcrcnet.org/sites/default/files/useruploads/Meetings/Board_of_Directors/2021/December_9_2021/BoardMeeting_Highlights_December_9_2021_FINAL.pdf
- 12/10: Eastern Sierra Council of Governments: approved MOU with Golden State Finance Authority for "revolving load fund" line of credit for the Eastern Sierra Pace and Scale Accelerator Project reimbursement grant from CA Dept of Fish and Wildlife; approved collection agreement with US Forest Service for the same project; approved acceptance of a proposal for project management for the same project with Whitebark Institute/Janet Hatfield
- 12/13: Behavioral Health Advisory Board Meeting

Supervisor Duggan:

- 12/09/21 – I participated in the OVGA meeting where we approved the final draft of the Groundwater Sustainability plan. I would like to thank the public for their commitment to providing expertise and context to the public comment process. I also want to thank Mono County Staff that acted as OVGA staff to the JPA overseeing the process and always keeping Mono County's interests in mind. The document represents many options, conclusions, and points of view on ways to manage our precious environment and economic resources throughout the region should the Basin ever be rerated to medium or above status. In January we will discuss next steps for staff and the board.
- 12/10/21 – ESTA Board meeting– I participated in the regular Board meeting for ESTA along with Supervisor Gardner. We elected officers for 2022, Commissioners Bill Sauser for Mono and Dan Tothoroth for Inyo, as Chair and Vice Chair, respectively. Ridership is up; we received excess Inyo local transportation funds, and the Board approved hero pay and vaccine incentives. Driver recruitment is still critical issue and threatens service levels for next spring in many incorporated and unincorporated areas.
- 12/13/21 – I participated in the Local Transportation Commission along with Commission Chair Kreitz and Commissioner Peters. We received a variety of reports, with special attention to an update on the MOU in SR 14/US395 projects. Focus at the State level is shifting away from increasing capacity on state highways (our projects), so we will be closely monitoring completion of these cooperative projects which also address safety for travelers along the 395 and 14 corridors in the southern region. I look forward to working on the Clean California grant opportunity. This can be great for Mono County to address clean-up and property protection ahead of the upcoming Benton Crossing Landfill Closure. \$5 million in funding is available; counties and non-profits can apply.

Note:

These draft meeting minutes have not yet been approved by the Mono County Board of Supervisors

Supervisor Gardner:

- On Dec. 7 I participated in a meeting of the Mono Basin Housing Committee. This group is looking at opportunities to increase housing, starting with a review of all property ownership in the Mono Basin.
- On Dec. 8 I participated in a special meeting of the ESSRP to hear a presentation of the final Sustainable Recreation and Tourism Initiative grant. There is good potential for creating Mono County projects from much of this work.
- Also, on Dec. 8 I attended the monthly meeting of the Mono Basin RPAC. Topics discussed included the proposed D&S Transfer Station on Rt. 167 and an update on Conway Ranch grazing.
- On Dec. 9 I participated in a Mammoth Voices event with our Clerk Recorder Scheereen Dedman regarding the elections next year.
- Also, on Dec. 9 I observed the monthly meeting of the County justice, Equity, Diversity, and Inclusion Working Group. The Group reviewed the first Implicit Bias Training session and discussed plans for other activities.
- On Dec. 10 I participated in the regular ESCOG meeting. We approved several contracts and grant proposals and discussed future opportunities for ESCOG.
- Also, on Dec. 10 I attended the monthly meeting of the ESTA Board of Directors. We reviewed operations and financial reports and discussed future service options.

Chair Kreitz

- December 8th I attended the NACo Community Economic Workforce and Development Committee meeting. Later I met with the MLH Development Committee to discuss a new possible HomeKey project in Mammoth Lakes.
- December 9th I attended the MLT Community Coffee, and then two more HomeKey application meetings with MLH staff and HCD staff and TA representative. Also on the 9th, I presented to the Mammoth Lakes Rotary on the Mono County redistricting process and reviewed the six maps.
- December 10, I participated in the regular meeting of the CCRH Board. There is a possible ballot measure being proposed and may qualify that would strip the state legislature from implementing and overriding local control on land-use matters.
- Yesterday, December 13th, I chaired my last meeting of the Mono County Transportation Commission.

Supervisor Peters:

- 12/8: attended the Northern Mono Chamber of Commerce – housekeeping items
- 12/9: conversation with Nevada County Supervisor Heidi Hall about Broadband and other CSAC related items
- Last week, participated in interview process for Bridgeport District Ranger
- Thanked Director of Public Works Dublino and Roads Department for continuing to work on parking solution at Virginia Lakes Road
- Thanked snow plow crews
- 12/10: toured Civic Center, met with CAO Lawton
- 12/13: attended LTC

Moved to Item 9.

ADJOURNED AT 2:32 PM.

ATTEST

Note:

These draft meeting minutes have not yet been approved by the Mono County Board of Supervisors

JENNIFER KREITZ
CHAIR OF THE BOARD

QUEENIE BARNARD
ASSISTANT CLERK OF THE BOARD



**OFFICE OF THE CLERK
OF THE BOARD OF SUPERVISORS**

REGULAR AGENDA REQUEST

Print

MEETING DATE January 18, 2022

Departments: CAO

TIME REQUIRED

SUBJECT Contract for Legal Services - Indigent
Defense

**PERSONS
APPEARING
BEFORE THE
BOARD**

AGENDA DESCRIPTION:

(A brief general description of what the Board will hear, discuss, consider, or act upon)

Proposed contract with attorney Josh Hillemeier pertaining to the provision of indigent defense services for Mono County.

RECOMMENDED ACTION:

Approve contract with attorney Josh Hillemeier to provide public defender services in Mono County for a period of two years commencing March 21, 2022, and ending March 20, 2024, and authorize Chair to execute said contracts on behalf of the County. Provide any desired direction to staff.

FISCAL IMPACT:

Not-to-exceed amount of \$180,000 annually, commencing in 2022, with 2% automatic annual increases.

CONTACT NAME: Robert C. Lawton

PHONE/EMAIL: 760-932-5415 / rlawton@mono.ca.gov

SEND COPIES TO:

MINUTE ORDER REQUESTED:

YES NO

ATTACHMENTS:

Click to download
Staff Report
Contract

History

Time	Who	Approval
1/12/2022 7:18 PM	County Counsel	Yes
1/12/2022 3:13 PM	Finance	Yes

1/14/2022 3:15 PM

County Administrative Office

Yes



COUNTY ADMINISTRATIVE OFFICER
COUNTY OF MONO
Robert C. Lawton
PO Box 696
Bridgeport, CA 93517-0696
(760) 932-5410
rlawton@mono.ca.gov
www.mono.ca.gov

BOARD OF SUPERVISORS

CHAIR

Bob Gardner / District 3

VICE CHAIR

Rhonda Duggan / District 2

Stacy Corless / District 5

Jennifer Kreitz / District 1

John Peters / District 4

COUNTY DEPARTMENTS

ASSESSOR

Hon. Barry Beck

DISTRICT ATTORNEY

Hon. Tim Kendall

SHERIFF / CORONER

Hon. Ingrid Braun

ANIMAL SERVICES

Malinda Huggins

BEHAVIORAL HEALTH

Robin Roberts

COMMUNITY DEVELOPMENT

Wendy Sugimura

COUNTY CLERK-RECORDER

Scheereen Dedman

COUNTY COUNSEL

Stacey Simon, Esq.

ECONOMIC DEVELOPMENT

Alicia Vennos

EMERGENCY MEDICAL

SERVICES

Chief Chris Mokracek

FINANCE

Janet Dutcher

CPA, GCFM, MPA

INFORMATION

TECHNOLOGY

Nate Greenberg

PROBATION

Karin Humiston

PUBLIC HEALTH

Bryan Wheeler

PUBLIC WORKS

Tony Dublino

SOCIAL SERVICES

Kathy Peterson

To: Board of Supervisors

From: Robert C. Lawton

Date: January 18, 2021

Re: Contract with attorney Josh Hillemeier for the provision of Public Defender Services

Recommended Action

Approve contract with attorney Josh Hillemeier to provide public defender services in Mono County for a period of two years commencing March 21, 2022, and ending March 20, 2024, for a not-to-exceed amount of \$180,000 annually in the first year, with 2% automatic annual increases.

Strategic Plan Focus Area(s) Met

Improve Public Safety & Health: Keep people from going back to jail by reducing future offenses. Provide quality representational services.

Improve County Operations: Improve operational efficiency and increase customer service and transparency.

Discussion

Mono County has historically contracted with three individuals or law firms to serve as public defenders in criminal and juvenile matters pending before the Mono County Superior Court.

The County recently approved contracts with attorneys Sophie Charlotte Bidet and Brad Braaten for two-thirds of the provision of these services. A third contract with an attorney/firm for public defender services expired on October 31, 2021, and the County issued a Request for Proposals for that contract. The County received proposals in response to the RFP, convened an independent panel to review the proposals, interview the candidates and make recommendations. Second-round interviews were conducted with the top two candidates and today recommend awarding a third public defender service contract to Mr. Hillemeier.

Mr. Hillemeier graduated from John F. Kennedy School of Law and has practiced criminal defense law in California for more than eight years, the past seven of which was as a contract public defender in Inyo County, handling more than 500 cases per year.

**CONTRACT BETWEEN THE COUNTY OF MONO
AND JOSH D. HILLEMEIER, ESQ.,
FOR THE PROVISION OF INDIGENT DEFENSE SERVICES**

The County of Mono, a political subdivision of the State of California, hereinafter referred to as “the County,” and Josh D. Hillemeier, Esq., as an individual, and referred to hereafter as “the Contractor,” agree to the provision of indigent defense services as outlined below. The County and the Contractor are sometimes referred to herein collectively as “the parties.”

RECITALS

- The County has a constitutionally mandated responsibility to provide indigent defense services.
- The County desires to have and agrees to pay for legal services performed for eligible persons entitled to public representation in Mono County by the Contractor, as authorized by law.
- The Contractor agrees that it will provide competent representation of clients as required by the controlling standards and rules of professional conduct.
- The County and the Contractor agree that any and all funds provided pursuant to this Contract are provided for the sole purpose of provision of legal services, including the cost of administrative services, to eligible clients of the Contractor.

TERMS AND CONDITIONS

The parties AGREE as follows:

1. DURATION OF CONTRACT

This Contract shall commence on March 21, 2022 and terminate on March 20, 2024, unless extended or terminated earlier in a manner allowed by this Contract. The County may, in its sole discretion, extend the term of this Contract for an additional period of up to five years by providing notice to Contractor at least 90 days prior to the date of termination.

2. DEFINITIONS

The following definitions control the interpretation of this Contract:

A. Eligible Client:

Eligible client means a person who is or has been determined by the Superior Court of the State of California in and for the County of Mono (hereinafter “the Court”) to be entitled to a court-appointed attorney, pursuant to relevant state statute, court rule, and constitutional provision, and who is one of the following:

1. All persons whom the Court has deemed indigent and who are charged with the commission of a misdemeanor or felony triable in any court in the County (including sexually violent predators).
2. All minors charged with a violation of Welfare and Institutions Code Section 601 or 602.

3. All persons the Court has deemed indigent, and for whom a petition for the appointment of an LPS conservator has been filed.
4. All persons the Court has deemed indigent seeking writs or appeals to the Superior Court in the type of cases described in this contract.
5. All persons the Court has deemed indigent and who are charged with a violation of misdemeanor probation.
6. All persons the Court has deemed indigent and who are charged with a violation of felony probation.
7. All persons the Court has deemed indigent and entitled to appointment of counsel in Welfare and Institutions Code Section 300 cases, and also any children who are the subject of such proceedings and who the Court has determined are entitled to appointed counsel. Note: under a separate Contract, the County currently receives compensation from the Courts for the provision of such legal services, and the County reserves the right to re-open and renegotiate the inclusion of such services in this Contract, and the compensation therefore, in the event that the courts ever refuse or cease to provide such compensation to the County.
8. All persons the Court has deemed indigent in probate or Lanterman-Petris Short Act (LPS Act) conservatorships and in which the Court appoints counsel.
9. All persons the Court has deemed indigent and subject to extradition.
10. All persons the Court has deemed indigent and subject to contempt.

B. Disposition:

1. Disposition in criminal cases means and/or includes:
 - a. The dismissal of charges
 - b. The entering of an order of deferred prosecution
 - c. An order or result requiring a new trial
 - d. Imposition of sentence
 - e. Deferral of any of the above coupled with any other hearing on that case number, including but not limited to felony or misdemeanor probation review
 - f. A restitution hearing ordered at the time of original disposition
 - g. The filing of a notice of appeal, if applicable
2. Disposition in other cases means:

In Welfare and Institutions Code Section 300 juvenile cases, termination of the proceedings; in Section 601 or 602 cases, disposition, unless there is an order for removal; or an order following a disposition hearing; in revocation of probation, a dismissal, or imposition of sentence; in all other cases, an adjudication in the trial court which constitutes a final order or judgment, unless reversed on appeal.

C. Representational Services: The services for which the County is to pay the Contractor are representational services, including but not limited to interviews of clients and potential witnesses, legal research, preparation and filing of pleadings, negotiations with the appropriate prosecutor or other attorneys and court regarding possible dispositions, and preparation for and appearance at all court proceedings.

D. Investigative Services: The services described in section 4.B.

E. Other Litigation Expenses: Other Litigation Expenses shall mean those expenses which are not part of this Contract with the Contractor. These include expert witness fees, language translators, laboratory analysis, other forensic services, court reporter fees, filing fees, transcript fees, witness fees and documents produced through discovery by the County in Welfare and Institutions Code section 300 or 600 cases. It is anticipated that payment for such expenses will be applied for in the appropriate courts by motion and granted out of separate funds reserved for that purpose. Payment for mitigation specialists in Capital cases, and for other expert attorney consultants as may be agreed upon between County and Contractor, is included in this category.

F. Misappropriation of Funds: Misappropriation of funds is the appropriation of funds received pursuant to this Contract for purposes other than those sanctioned by this Contract. The term shall include the disbursement of funds for which prior approval is required but is not obtained.

3. INDEPENDENT CONTRACTOR

The Contractor is, for all purposes arising out of this Contract, an independent contractor, and neither the Contractor nor its employees shall be deemed employees of the County. The Contractor shall complete the requirements of this Contract according to the Contractor's own means and methods of work, which shall be in the exclusive charge and control of the Contractor and which shall not be subject to control or supervision by the County, except as specified herein.

4. SCOPE OF SERVICES

A. Together with other indigent defense counsel under direct contract with County, Contractor, shall provide representational services to all eligible clients in Mono County trial court actions or proceedings.

B. Contractor may utilize the services of a licensed private investigator ("Investigator") under Business and Professions Code section 7520 and 7521, with whom the County has entered into a separate contract for services, or of any other Investigator upon appointment by the Court in a particular case. Investigator services shall be used in the context of any of the representational services covered by this Contract, including but not limited to securing evidence to be used before the Courts of Mono County. Investigators shall not perform services of a clerical or administrative nature and which do not require the services of a licensed private investigator, nor shall Investigators be used for the purpose of serving subpoenas on witnesses or custodians of record. Notwithstanding the foregoing, an Investigator may be used for the purpose of serving subpoenas on witnesses or custodians of record at no additional cost to the County and provided Contractor assumes the cost.

5. CONTRACTOR'S OFFICES, EMPLOYEES AND CONFLICT AVOIDANCE

- A. Contractor shall have physically separate offices from any other attorney under contract with County to provide indigent defense services. Contractor shall maintain an ethical and communications wall between Contractor and such attorney(s) about their respective cases, to maintain the confidences of clients.
- B. Contractor agrees not to accept compensation directly or indirectly from any source other than the County on cases assigned pursuant to this Contract.
- C. Contractor shall maintain the right to have private clients outside of this Contract; provided, however, that it shall structure its private practices in such a way as to avoid any conflicts with representational services provided pursuant to this Contract.
- D. Contractor further agrees that it has no interest, and shall not acquire any interest, direct or indirect, which would conflict in any manner or degree with Contractor's performance of the work and services under this Contract. Specifically, Contractor agrees not to engage in any private legal representations of any matter which would conflict or interfere with Contractor's ability to represent clients under this Contract.
- E. Contractor agrees that it has secured or will secure at its own expense, all persons, employees, office space within Mono County and equipment required to perform the service contemplated/required under this Contract.

6. MINIMUM QUALIFICATIONS FOR ATTORNEY PROVIDING INDIGENT DEFENSE SERVICES

- A. Contractor shall be licensed to practice law in California (i.e., shall be an active member of the California State Bar), shall have been a practicing attorney in all of the courts of the State for at least the year preceding the date of appointment, and shall be in full compliance with any applicable mandatory continuing legal education (MCLE) requirements. Contractor will maintain for inspection on its premises records of Contractor compliance these requirements.
- B. Prior to representing a defendant accused of a homicide, Contractor must have served at least five years as a prosecutor, a public defender, or assigned counsel within a formal assigned counsel plan that included training, or have demonstrably similar experience, and been trial counsel and handled a significant portion of the trial in at least two felony cases that have been submitted to a jury.
- C. Prior to representing a defendant accused of a serious felony as defined by Penal Code section 1192.7, or of a violent felony as defined by Penal Code section 667.5, other than a homicide, Contractor must have served at least three years as a prosecutor, a public defender, or assigned counsel within a formal assigned counsel plan that included training, or have demonstrably similar experience, and been trial counsel and handled a

significant portion of the trial in at least two felony cases, that have been submitted to a jury.

D. Contractor representing a party in a juvenile case shall have the knowledge and experience in juvenile law as required by Welfare and Institutions Code section 317.6 and the standards established by the Judicial Council.

E. Contractor shall have served at least three years as a prosecutor, a public defender, or assigned counsel within a formal assigned counsel plan that included training, or have demonstrably similar experience, and/or been sole trial counsel of record in twenty misdemeanor cases brought to final resolution, or been sole or co-trial counsel and handled a significant portion of the trial in at least two felony criminal cases that have been submitted to a jury alone or of record with other trial counsel.

F. Failure on the part of the Contractor to have or obtain the appropriate amount of experience shall be considered a material breach of this Contract.

7. PERFORMANCE REQUIREMENTS

A. Contractor shall provide quality representational services to all eligible clients to whom the Contractor is appointed by the Court, consistent with any applicable rules of professional conduct and standards of care. Specifically, the following duties and responsibilities of Contractor as appointed by the Court shall be observed:

1. Provide careful, factual and legal investigation.
2. Take prompt action to protect client's legal rights.
3. Make all necessary court appearances for motions, trials, adjudications, hearings, dispositions, and sentencing.
4. Prepare for jury selections, examination of witnesses, submission of instructions, and presentation of argument at trial.
5. Know and explore sentencing alternatives.
6. Advise the client concerning appeals.
7. Not accept more cases than can be competently handled.
8. Not handle a legal matter which the Contractor knows or should know that it is not competent to handle.
9. Maintain client confidences.
10. Keep the client informed.
11. Comply with all standards of performance set by the Courts and rules in juvenile cases.
12. Not accept a matter in which a conflict of interest exists of which it would be otherwise prohibited from accepting under the Rules of Professional Conduct of the State Bar.

B. Except as provided herein, the Contractor shall maintain appropriate staff to adequately perform the work and services provided in this Contract and to address the needs of Contractor's clients. Contractor will be timely available for all Court appearances and meet all performance requirements of this Contract and of the Courts.

C. Contractor shall maintain adequate office space and hours in Mono County during normal business hours for appointments with potential eligible clients who are not in custody. Contractor shall maintain published office addresses and phone numbers and telephone answering services or devices for the taking of telephone messages during non-business hours. Contractor shall make return calls within 24 hours of all calls from clients for which a message is left requesting a return call.

D. In-custody eligible clients shall be interviewed within 72 hours, excluding weekends and holidays, of Contractor appointment. Out of custody eligible clients may make an appointment with Contractor who shall make available an appointment at an office in Mono County within five business days of Contractor appointment. In all cases, Contractor shall personally speak with the client prior to the date of the first court appearance following appointment by the Court.

E. Contractor shall keep all courts informed of the status of pending cases to which it has been appointed and shall advise the courts at the earliest possible time as to whether cases will be settled or go to trial, whether continuances are needed, whether or when interpreters will be needed, and other such matters bearing on the scheduling of cases before the courts.

F. Contractor shall adequately cover all courts within the County through which services are to be provided under this Contract. "Adequately cover" means generally that the business of the court is not unreasonably delayed because of the absence of/or lack of preparation of the Contractor.

G. In the event that Contractor is unable to appear for any matter to which he or she has been appointed, then he or she shall arrange for other counsel to appear on his or her behalf, at no cost to the County.

8. CONTRACTOR EVALUATION

At least annually during the term of this Contract, and any extension thereof, , the County Counsel, County Finance Director and County Administrative Officer shall meet with the Contractor and the Judges of the court to ensure that the performance standards set forth herein are being met. If upon said evaluations, or at any other time based on competent evidence, the County determines that the Contractor is failing to provide competent legal services or has engaged in conduct that, if Contractor were an employee of the County, would violate the Mono County Personnel System, the County may terminate this Contract as provided in section 15.

9. COMPENSATION AND METHOD OF PAYMENT

A. For services provided under this contract, County shall pay Contractor \$15,000 per month for the period of March 21, 2022, through December 31, 2022. This amount shall be paid monthly within 15 days following the end of month in which services are provided and shall be increased by two percent (2%) on January 1, 2023 and again on January 1, 2024. In the event that this Contract is extended pursuant to section 1, annual increases shall continue to be 2%.

B. The compensation payable under section 9.A is the maximum amount which County must pay under this Contract, and Contractor shall assume and pay all other expenses incurred in the performance of this Contract or seek court order for payment of such amounts as Other Litigation Expenses. Contractor represents that Contractor is informed and has made its own independent investigation of the facts and circumstances surrounding the provision of public defense services in Mono County, including its own experience in providing such services and the issues involving the administration of this contract. The Contractor and County acknowledge that many factors outside the control of the parties can affect the ability of the Contractor to accurately project caseloads and work levels with certainty. Such factors as the length of time between arraignment and trial, local sentencing practices, and pleading negotiation practice are largely controlled by the courts and the prosecution. The parties recognize that during the term of this Contract, changes may occur in the operations of the County's criminal justice system which may cause additional expense to Contractor. Notwithstanding any such changes, the Contractor agrees to the compensation set forth in this Contract for services to be rendered.

C. County shall receive all funds collected pursuant to Penal Code section 987.4, 987.6, and 987.8, Government Code section 27712, and any similar statute or Contract providing for reimbursement for the costs of legal services rendered under this Contract, and no portion of said funds inure for the benefit of Contractor or otherwise affect the amount specified to be paid to Contractor under this contract.

D. Other litigation expenses, as defined in section 2.E, shall be paid by County upon Contractor submitting a county claim form, to which shall be attached to an order of the Court fixing the expenses to be paid. Each claim shall include:

1. The name of the client and case number;
2. The date and time the services were provided, in 10th hour increments;
3. A description of the services provided on each date.

Any claim for which the above is not provided shall be deemed an insufficient claim.

E. Contractor shall be solely responsible for providing and paying the cost of all utilities, photocopies, facsimiles, telephones, postage, office furniture, equipment, supplies, secretaries, clerks, staff attorneys, transportation, and other materials, services, and persons necessary to perform this Contract. Notwithstanding the foregoing, in complex and/or voluminous cases, Contractor may file a motion with the Court, with five (5) business days advanced notice to County, for payment by County of any of the above expenses, where such costs are expected to, or actually do, exceed those incurred in a typical case.

F. County has no obligation to withhold any taxes or other payments from the sums paid Contractor by County pursuant to this Contract. Payment of taxes as required by law is the sole responsibility of Contractor.

10. REPORTS AND INSPECTIONS

A. Contractor agrees to submit to the County the following reports at the times prescribed below. Failure to submit required reports may be considered a breach of this contract and may result in the County withholding payment until the required reports are submitted and/or until invocation of the Corrective Action procedures in Section 14 (Corrective Action).

B. Contractor shall provide the County Administrative Officer (CAO) a quarterly report of services rendered by Contractor during the previous calendar quarter using the form attached to this Contract as Exhibit A and incorporated by this reference, or such other form as may be provided by County for these purposes. The report shall be submitted within ten working days after the end of each calendar quarter and shall include:

1. The number of cases to which Contractor has been appointed during that quarter distinguished between misdemeanor, felony, juvenile, conservatorship and appeal.
2. The number of open cases during that quarter distinguished between misdemeanor, felony, juvenile, conservatorship and appeal.
3. The number of cases closed during that quarter distinguished between misdemeanor, felony, juvenile, conservatorship and appeal.
4. Disposition of cases during that quarter by the following categories: Pleas, trials, diversions, dismissals, and other.
5. The number of cases during that quarter in which Contractor has declared a conflict.

C. Bar Complaints: Contractor shall immediately notify the County in writing if the Contractor becomes aware that a complaint lodged with the State Bar Association has resulted in the public or private reproof, suspension, or disbarment of any attorney providing services under this Contract. In the event of a report of a private reproof, County shall maintain confidentiality of said report to the extent permitted by law.

D. Inspections: Contractor agrees to grant the County full access to materials necessary to verify compliance with all terms of this Contract. At any time, upon reasonable notice during business hours and as often as the County may reasonably deem necessary for the duration of the Contract and a period of five years thereafter, the Contractor shall provide to the County right of access to its facilities, to audit information relating to the matters covered by this Contract. Information that may be subject to any privilege or rules of confidentiality should be maintained by the Contractor in a way that allows access by the County without breaching such confidentiality or privilege. The Contractor agrees to maintain this information in an accessible location and condition for a period of not less than five years following the termination of this Contract, unless the County agrees in writing to an earlier disposition. Notwithstanding any of the above provisions of this section, none of the constitutional, statutory, and common law rights and privileges of any client are waived by this Contract. The County will respect the attorney-client privilege and attorney work-product privilege.

11. ESTABLISHMENT AND MAINTENANCE OF RECORDS

A. Contractor shall prepare and maintain records sufficient to enable County and the courts to determine the cost of representing each person represented by Contractor, and Contractor shall provide the court with the total time of each case upon disposition or upon request of the court or the County.

B. Records shall be maintained for a period of five years after termination of this Contract unless permission to destroy them is granted by the County.

12. HOLD HARMLESS AND INDEMNIFICATION

A. The County assumes no responsibility for the payment of any compensation, wages, benefits, or taxes by the Contractor or its employees or others by reason of the Contract. Contractor shall protect, indemnify, and save harmless the County, its officers, agents, and employees from and against any and all claims, costs, and losses whatsoever, occurring or resulting from Contractor's failure to pay any compensation, wages, benefits or taxes except where such failure is due to the County's wrongful withholding of funds due under this Contract.

B. Contractor agrees that it is financially responsible and liable for and will repay the County for any material breaches of this contract including but not limited to misuse of Contract funds due to the negligence or intentional acts of the CONTRACTOR, its employees, representatives or agents.

C. Contractor shall defend, indemnify, and hold harmless County, its agents, officers, and employees from and against all claims, damages, losses, judgments, liabilities, expenses, and other costs, including litigation costs and attorney's fees, arising out of, resulting from or in connection with, the performance of this Contract by Contractor, or its agents, officers, or employees. Contractor's obligation to defend, indemnify, and hold the County, its agents, officers, and employees harmless applies to any actual or alleged personal injury, death, damage or destruction to tangible or intangible property, including the loss of use. Contractor's obligation under this section extends to any claim, damage, loss, liability, expense, or other costs that are caused in whole or in part by any act or omission of a Contractor, its agents, employees, supplier, or anyone directly or indirectly employed by any of them, or anyone for whose acts or omissions any of them may be liable.

Contractor's obligation to defend, indemnify, and hold the County, its agents, officers, and employees harmless under the provisions of this section is not limited to, or restricted by, any requirement in this Contract for Contractor to procure and maintain a policy of insurance.

Contractor shall not claim, and/or do hereby knowingly and voluntarily waive, any right to defense or indemnification by County as a County employee or officer.

13. INSURANCE

Certificates of insurance and requested endorsements, for all stated insurances, shall be provided to the Mono County Risk Management at least ten (10) days prior to the start of

services to be performed by the Contractor. The policy/policies shall maintain a provision prohibiting the cancellation or modification of said policy except upon thirty (30) days prior written notice to the County Risk Manager.

A. Business Vehicle. If Contractor, or any employee or agent thereof, utilizes a motor vehicle in performing any of the work or services identified in Attachment A (Scope of Work), the Contractor shall procure and maintain in force throughout the duration of this Contract, a business auto liability insurance policy with minimum coverage levels of \$250,000.00 per occurrence, combined single limit for bodily injury liability and property damage liability. The coverage shall include all Contractor -owned vehicles and all hired and non-owned vehicles used in performing under this Contract.

B. Workers' Compensation. (Mark applicable paragraph):

Contractor shall provide Statutory Workers' Compensation insurance coverage and Employer's Liability coverage for not less than \$1 million (\$1,000,000.00) per occurrence for all employees engaged in services or operations under this Agreement. Any insurance policy limits in excess of the specified minimum limits and coverage shall be made available to County as an additional insured. The Workers' Compensation policy shall be endorsed with a waiver of subrogation in favor of County for all work performed by Contractor, its employees, agents, and subcontractors.

Contractor is exempt from obtaining Workers' Compensation insurance because Contractor has no employees. Contractor shall notify County and provide proof of Workers' Compensation insurance to County within 10 days if an employee is hired. Such Workers' Compensation policy shall be endorsed with a waiver of subrogation in favor of County for all work performed by Contractor, its employees, agents, and subcontractors. Contractor agrees to defend and indemnify County in case of claims arising from Contractor's failure to provide Workers' Compensation insurance for employees, agents and subcontractors, as required by law.

C. Professional Liability Insurance. Contractor shall provide professional liability insurance in the amount of not less than one million dollars (\$1,000,000.00) each occurrence/one million (\$1,000,000.00) policy aggregate. Proof of such insurance shall be provided to County at least ten (10) days prior to the start of any work by Contractor.

If professional liability coverage is written on a claims-made form:

1. The "retro Date" must be shown and must be before the date of the contract of the beginning of contract work.
2. Insurance must be maintained and evidence of insurance must be provided for at least five (5) years after completion of the contract work.

3. If coverage is cancelled or non-renewed, and not replaced with another claims-made policy form with a "Retro Date" prior to the contract effective date, the Contractor must purchase "extended reporting" coverage for a minimum of five (5) years after completion of contract work.

D. Deductible and Self-Insured Retentions. Any deductibles or self-insured retentions must be declared and approved by Mono County Risk Manager. If possible, the Insurer shall reduce or eliminate such deductibles or self-insured retentions as respects to Mono County, its officials, officers, employees and volunteers; or the Contractor shall provide evidence satisfactory to Mono County Risk Manager guaranteeing payment of losses and related investigations, claim administration, and defense expenses.

14. CORRECTIVE ACTION

If the CAO reasonably believes that a material breach of this Contract has occurred, warranting corrective action, the following sequential procedure shall apply:

1. The CAO will notify the Contractor in writing of the nature of the breach.
2. The Contractor shall respond in writing within five working days of receipt of such notification, which response shall present facts to show no breach exists or indicate the steps being taken to correct the specified deficiencies, and the proposed completion date for bringing the Contract into compliance.
3. The CAO will notify the Contractor in writing of the County's determination as to the sufficiency of the Contractor's corrective action plan. The determination of the sufficiency of the Contractor's corrective action plan will be at the discretion of the CAO and will take into consideration the reasonableness of the proposed corrective action in light of the alleged breach, as well as the magnitude of the deficiency in the context of the Contract as a whole. In the event the Contractor does not concur with the determination, the Contractor may request a review of the decision by the Board of Supervisors. County agrees that it shall work with the Contractor to implement an appropriate corrective action plan accepted by the CAO or, if review has been requested, by the Board of Supervisors.

In the event that Contractor does not respond to the CAO's notification within the appropriate time, or the Contractor's corrective action plan for a substantial breach is determined by the CAO, following review by the Board of Supervisors if requested, to be insufficient, the County may commence termination of this Contract in whole or in part pursuant to section 15 (Termination and Suspension.)

In addition, the County reserves the right to withhold a portion of subsequent payments owed the Contractor which are directly related to the breach of the Contract until the County is satisfied that corrective action has been taken or completed as described in section 9 (Compensation and Method of Payment.)

15. TERMINATION AND SUSPENSION

- A. County may terminate this Contract in whole or in part upon 15 days written notice to the Contractor in the event that the Contractor under this contract:
1. Materially breaches any duty, obligation, or service required pursuant to this Contract;
 2. Engages in misappropriation of funds or misconduct as described in the Mono County Personnel System; or
 3. The duties, obligations, or services herein become illegal, or not feasible.

Before the County terminates this Contract pursuant to this section 15, the County shall provide the Contractor written notice of termination, which shall include the reasons for termination and the effective date of termination. The Contractor shall have the opportunity to submit a written response to the County within ten working days from the date of the County's notice. If the Contractor elects to submit a written response, the CAO will review the response and make a determination within ten days after receipt. In the event the Contractor does not concur with the determination of the CAO, the Contractor may request a review of the decision by the County Board of Supervisors. In the event the County Board of Supervisors reaffirms termination, the Contract shall terminate in ten days from the date of the final decision of the County Board of Supervisors. The Contract will remain in full force pending such termination. Contractor understands and agrees that any such decision shall be final and binding and shall not be appealable nor otherwise subject to judicial review of any kind.

B. Contractor reserves the right to terminate this Contract with cause with 15 days written notice should the County materially breach any duty, obligation or service pursuant to this Contract. Prior to such termination, Contractor shall provide County with written notice of the alleged breach and County shall have 30 days in which to cure the breach. In the event that the Contractor terminates this Contract for reasons other than good cause resulting from a material breach of this Contract by the County, the Contractor shall be liable for damages, including the excess costs of the procurement of similar services from another source, unless it is determined by the CAO that (i) no default actually occurred, or (ii) the failure to perform was without the Contractor's control, fault or negligence.

C. County or Contractor may terminate this Contract at will and without cause by providing one hundred and eighty (180) days' written notice to the other party of the intent to terminate.

D. Following termination or suspension of this Contract, the Contractor shall continue to represent clients that were previously assigned, at an hourly rate determined by the Courts, and the County will be liable for any payments owed for the completion of that work. The Contractor shall remit to the County any monies paid for cases not yet assigned or work not performed under the Contract. The CAO may request that the Contractor attempt to withdraw from any case assigned and not completed, and in that event, Contractor shall use best efforts to so withdraw. Should a court require, after the Contractor has attempted to withdraw, the appearance of counsel from the Contractor on

behalf of any client previously represented by the Contractor where such representation is no longer the obligation of the Contractor pursuant to the terms of this Contract, the County will honor payment to the Contractor upon judicial verification that continued representation is required.

E. In the event that termination is due to misappropriation of funds, non-performance of the scope of services, or fiscal mismanagement, the Contractor shall return to the County those funds, unexpended or misappropriated, which, at the time of termination, have been paid to the Contractor by the County.

F. Otherwise, this Contract shall terminate on the date specified herein, and shall be subject to extension as provided in section 1.

G. The ability of the County to enter into this Contract is based upon available funding from various sources. In the event that such funding fails, is reduced, or is modified, from one or more sources or is not appropriated, at any time during the term of this Contract County has the option without incurring any penalty or breaching this Contract to terminate, reduce, or modify this Contract, or any of its terms within ten (10) days of notifying Contractor of the termination, reduction, or modification of available funding. Upon receipt of such notice, Contractor may at its option terminate this Contract without incurring any penalty or breaching the Contract.

16. FINANCIAL RESPONSIBILITY

The Contractor shall remain financially solvent during the term of this Contract. Voluntary or involuntary bankruptcy proceedings by the Contractor, when not released within ten (10) business days, shall constitute a material breach of this Contract. Bankruptcy by the Contractor under this contract shall constitute a ground for termination of the Contract.

17. ASSIGNMENT/SUBCONTRACTING

A. The Contractor shall not assign or subcontract any portion of this Contract without consent of the County. Any consent sought must be requested by the Contractor in writing not less than ten days prior to the date of any proposed assignment or subcontract, provided that this provision shall not apply to special appearances made on behalf of the Contractor under this Contract while he or she is on vacation or otherwise unavailable for limited periods of time. Any individuals entering into subcontract (with written approval of County) shall meet all experience requirements imposed by this Contract. County shall be notified of any subcontracts which are renewed, extended or repeated at any time throughout the Contract. This provision is not intended to prohibit another attorney from making a special appearance on behalf of the Contractor under this contract.

B. The term "Subcontract" as used above shall not be read to include the purchase of support services that do not directly relate to the delivery of legal services under the Contract to clients of the Contractor.

C. Each subcontractor providing services under this Contract, prior to first providing such services, shall be required to sign a contract under which, at a minimum, the subcontractor agrees to comply with and be bound by the terms and conditions of this Contract. Such contract shall be in a form acceptable to the County. A fully executed copy of such contract shall be provided to the CAO before a subcontractor may begin to provide services under this Contract. The County shall have the right to interview all subcontractors before subcontractor may begin to provide services, and may reject any subcontractor which the County reasonably deems to be not qualified. Upon request of the Contractor, the County shall state in writing the reasons upon which it makes such determination, which may not be arbitrary or capricious.

18. NOTICES

Whenever this Contract provides for notice to be provided by one party to another, such notice shall be in writing and addressed as follows:

If to Contractor:
Josh Hillemeier
201 S. Warren Street
Bishop, CA 93514
joshhillemeier@gmail.com

If to County:
County Administrative Officer
PO Box 696
Bridgeport, CA 93517
rlawton@mono.ca.gov

With a copy to:
Mono County Counsel
PO Box 2415
Mammoth Lakes, CA 93546
ssimon@mono.ca.gov

19. TRANSFER OF CASES UPON TERMINATION OF CONTRACT

Upon termination of this Contract pursuant to section 15 or upon expiration or, Contractor shall cooperate fully with the County and with such persons as may be designated by County to succeed Contractor in order to effect the orderly transition of legal services from Contractor to his or her successor. The cooperation specified in this section includes, but is not limited to, the releasing of such files, papers, and records in good order as may be required in order to carry out the provisions of this contract and any subsequent Contract with a successor Contractor and to ensure the continued adequate legal representation of persons eligible for services herein set forth.

20. NONDISCRIMINATION

During the performance of this Contract, neither Contractor nor any party subcontracting with the Contractor under the authority of this Contract shall discriminate on the basis of race, color, sex, religion, national origin, creed, marital status, age, sexual orientation, or

the presence of any sensory, mental, or physical handicap in employment or application for employment or in the administration or delivery of services or any other benefit under this Contract, nor on any other basis prohibited by state or federal law in effect during this Contract.

The Contractor shall comply fully with all applicable federal, state, and local laws, ordinances, executive orders, and regulations which prohibit such discrimination.

21. CONFLICT OF INTEREST

No officer, employee, or agent of the County, or the State of California, or the United States Government, who exercises any functions or responsibility in connection with the planning and implementation of the program funded herein shall have any personal financial interest, direct or indirect, in this Contract, or Contractor. If required by state law or by the County's own conflict of interest code, Contractor shall comply with said laws and code, including but not limited to filing any required statement of economic interests.

22. MISCELLANEOUS PROVISIONS

The parties agree that this Contract is the complete expression of the terms hereto and any oral representations of understanding not incorporated herein are excluded. No other representations, covenants, undertakings or other prior or contemporaneous agreement, oral or written, respecting such matters, which are not specifically incorporated herein, shall be deemed in any way to exist or bind any of the parties hereto. The parties, and each of them, further acknowledge that they have not executed this Contract in reliance on any such promise, representation or warranty.

Both parties recognize that time is of the essence in the performance of the provisions of this Contract.

Waiver of any default shall not be deemed to be a waiver of any subsequent default. Waiver of a breach of any provision of this Contract shall not be deemed to be a waiver of any other subsequent breach and shall not be construed to be a modification of the terms of this Contract unless stated to be such through written mutual agreement of the parties, which shall be attached to the original Contract.

This Contract shall be binding upon the parties and upon their heirs, administrators, representatives, executors, successors and assigns, and shall inure to the benefit of the parties and all related persons or entities, and each of them, and to their heirs, administrators, representatives, executors, successors and assigns.

The parties hereto, and each of them, acknowledge that this Contract is executed voluntarily by all of them, without duress or undue influence on the part or on behalf of any of them. The parties further acknowledge that they have been represented by counsel with respect to the negotiation and preparation of this settlement agreement or do hereby knowingly waive their right to do so, and that they are fully aware of the contents of this Contract and of its legal effect.

The parties have jointly participated in the preparation and drafting of this Contract. Thus, any ambiguity therein shall not be construed in favor of or against either party.

EXECUTION

IN WITNESS THEREOF, THE PARTIES HERETO HAVE SET THEIR HANDS THROUGH THEIR AUTHORIZED REPRESENTATIVES THIS ____ DAY OF _____, _____.

COUNTY OF MONO

CONTRACTOR

By: _____

By: _____

Dated: _____

Dated: _____

APPROVED AS TO FORM:

County Counsel

APPROVED BY RISK MANAGEMENT:



**OFFICE OF THE CLERK
OF THE BOARD OF SUPERVISORS**

REGULAR AGENDA REQUEST

Print

MEETING DATE January 18, 2022

Departments: County Counsel

TIME REQUIRED

SUBJECT Mono County Lactation Policy

**PERSONS
APPEARING
BEFORE THE
BOARD**

AGENDA DESCRIPTION:

(A brief general description of what the Board will hear, discuss, consider, or act upon)

Proposed resolution adopting a Lactation Accommodation Policy and Request Form and amending Mono County's Personnel Rules applicable to all employee bargaining units to add Section 345 "Lactation Accommodation."

RECOMMENDED ACTION:

Adopt proposed resolution. Provide any desired direction to staff.

FISCAL IMPACT:

At the Board's direction, the proposed policy would provide paid break time for lactation purposes of up to 30 minutes (as opposed to the State law required 15 minutes of paid time) when taken in conjunction with an employee's regularly-scheduled break time.

CONTACT NAME: Stacey Simon

PHONE/EMAIL: x1704 / ssimon@mono.ca.gov

SEND COPIES TO:

MINUTE ORDER REQUESTED:

YES NO

ATTACHMENTS:

Click to download
Staff report
Resolution
Exhibit - Lactation Accommodation Request Form

History

Time

Who

Approval

1/12/2022 4:54 PM	County Counsel	Yes
1/12/2022 1:04 PM	Finance	Yes
1/14/2022 3:16 PM	County Administrative Office	Yes

County Counsel
Stacey Simon

Assistant County Counsel
Anne L. Frievault

Deputy County Counsel
Emily R. Fox

**OFFICE OF THE
COUNTY COUNSEL**
Mono County

South County Offices
P.O. BOX 2415
MAMMOTH LAKES, CALIFORNIA 93546

Telephone
760-924-1700

Risk Manager
Jay Sloane

Paralegal
Kevin Moss

To: Board of Supervisors

From: Office of the County Counsel

Date: January 18, 2022

Re: Lactation Accommodation Policy and Request Form

Recommended Action

Adopt proposed Resolution adopting a Lactation Accommodation Policy and Request Form and amending Mono County's Personnel Rules applicable to all employee bargaining units to add Section 345 "Lactation Accommodation."

Strategic Plan Focus Areas Met

Economic Base Infrastructure Public Safety
 Environmental Sustainability Mono Best Place to Work

Discussion

California Labor Code Sections 1030-1034 require employers in California to provide a reasonable amount of break time to accommodate an employee desiring to express breast milk for the employee's infant child. Under those sections, employees must be provided 15 minutes of paid break time, which should be taken concurrently with the employee's regularly-scheduled break period. Time spent outside of regularly-scheduled break time need not be paid.

This Board has given direction that the benefits available to lactating employees under Sections 1030-1034 should be expanded to include up to 30 minutes of paid break time. The Board has additionally directed that such policy be adopted as part of the Mono County Personnel Rules, where it may be easily accessed by managers and employees.

The attached Resolution would carry out the above direction by incorporating the requirements of Sections 1030-1034 into the Mono County Personnel Rules applicable to all bargaining units, with the period of paid break time expanded from 15 to 30 minutes. The Resolution would also adopt a form for use by employees requesting lactation accommodation.

If you have any questions regarding this item prior to your meeting, please call me at 760-924-1704.



R22-__

**A RESOLUTION OF THE MONO COUNTY BOARD OF SUPERVISORS
ADOPTING A LACTATION ACCOMMODATION POLICY
FOR MONO COUNTY EMPLOYEES AND ADDING SECTION 345 TO THE
MONO COUNTY PERSONNEL RULES TO INCORPORATE SAID POLICY**

WHEREAS, California Labor Code Sections 1030-1034 (the “Law”) requires employers in California to provide a reasonable amount of break time to accommodate an employee desiring to express breast milk for the employee’s infant child; and

WHEREAS, the Law provides for 15 minutes of paid break time, to be taken concurrently with the employee’s regularly-scheduled break period (or unpaid if at another time); and

WHEREAS, Mono County supports the rights of lactating employees and wishes to expand upon the Law by providing up to 30 minutes of paid break time to employees expressing breast milk and, additionally, by adopting this lactation policy into its Personnel Rules, where it will be easily accessible to all managers and employees; and

NOW, THEREFORE, THE BOARD OF SUPERVISORS OF THE COUNTY OF MONO RESOLVES that:

SECTION ONE: This Mono County Lactation Accommodation Policy applies to all Mono County employees. If a provision of this policy conflicts with any provision of a valid memorandum of understanding between Mono County and a recognized employee organization, the provision of the memorandum of understanding that is in conflict shall apply to employees covered by that memorandum of understanding, to the extent that the provision does not conflict with applicable state or federal law.

SECTION TWO: Pursuant to Labor Code Section 1034c, this Lactation Policy will be provided to all new hires, and whenever an employee makes an inquiry about parental leave.

SECTION THREE: The following is adopted as the policy of the County and shall be added to the Mono County Personnel Rules applicable to all employee bargaining units:

“Personnel Rule 345

1
2 County employees have a right to request lactation accommodation. The County will
3 provide a reasonable amount of break time to accommodate any employee desiring to
4 express breast milk for the employee's infant child each time the employee has a need to
5 express milk. The break time shall, if possible, run concurrently with any break time
6 already provided to the employee and each lactation break may extend to up to 30
7 minutes of paid time. If the employee takes a lactation break that exceeds 30 minutes,
8 then the time exceeding 30 minutes shall be unpaid, or the employee may choose to use
9 accrued leave.

10 Those desiring to take a lactation break at times other than their provided break times
11 must notify a supervisor prior to taking such a break. Breaks may be reasonably delayed
12 if they would seriously disrupt operations. Once a lactation break has been approved, the
13 break should not be interrupted except for emergency or exigent circumstances.

14 The County will provide a room or other appropriate location in close proximity to the
15 employee's worksite that is not in a bathroom to express milk in private. The room or
16 location will meet the following requirements:

- 17 (a) Be accessible to the employee without needing to obtain access (e.g., a key or that a
18 door be unlocked) from a third party;
- 19 (b) Be shielded from view and free from intrusion while being used to express milk;
- 20 (c) Be safe, clean, and free of hazardous materials as defined in Labor Code section
21 6382;
- 22 (d) Contain a surface on which to place a breast pump and personal items;
- 23 (e) Contain a place to sit; and
- 24 (f) Have access to electricity needed to operate an electric battery-powered breast
25 pump.

26 An employee occupying such private area shall either secure the door or otherwise make
27 it clear to others through signage that the area is occupied and should not be disturbed.
28 All other employees should avoid interrupting an employee during an authorized break
29 under this section, except to announce an emergency or other urgent circumstance.
30 When a multipurpose room is used for lactation, the use of the room for lactation shall
31 have precedence over other uses, but only during the time it is in use for lactation
32 purposes.

The County will provide access to a sink with running water and a refrigerator, or other
cooling device, suitable for storing milk, in close proximity to the employee's work area.

1 **Employee Request for Lactation Accommodation**

2 An employee may request an accommodation for lactation breaks by submitting a
3 lactation accommodation request form (to be provided by County and made available on
4 the County’s intranet site) to the designated department supervisor.

5 The department supervisor must respond to the employee’s accommodation request in
6 writing on the same lactation accommodation request form submitted by the employee
7 indicating the approval or denial of the break request. The completed request form must
8 be returned to the employee and a copy sent to the Human Resources Department.

9 The requested break time should, if possible, be taken concurrently with other scheduled
10 break periods. Non-exempt employees must clock out for any lactation breaks that do
11 not run concurrently with normally scheduled rest periods. Any such breaks will be
12 unpaid.

13 **SECTION FOUR:** The Lactation Accommodation Form attached to this Resolution as
14 an Exhibit, or a substantively similar form, shall be made available to employees upon request
15 and through the County’s intranet site.

16 **SECTION FIVE:** Employees have the right to file a complaint with the Labor
17 Commissioner for any violation of rights provided under Chapter 3.8 of the California Labor
18 Code regarding lactation accommodations.

19 **PASSED, APPROVED and ADOPTED** this ____ day of _____, 2022, by
20 the following vote, to wit:

21 **AYES:**

22 **NOES:**

23 **ABSENT:**

24 **ABSTAIN:**

25 _____
26 Bob Gardner, Chair
27 Mono County Board of Supervisors

28 **ATTEST:**

29 **APPROVED AS TO FORM:**

30 _____
31 Clerk of the Board

32 _____
County Counsel



LACTATION ACCOMMODATION REQUEST FORM

EMPLOYEE INFORMATION

Print Full Name:		<input type="checkbox"/> Current Employee
		<input type="checkbox"/> Other
Address:		Phone Number:
Title:	Email:	
Office Telephone Number:	Division:	Supervisor Name and Phone Number:
Location:		
Date of Form:	Please Anticipate Schedule of Usage (times; e.g., between 10am-12pm):	
Anticipated First Date of Use:		
Any Other Information Related to Request for Lactation Accommodation:		
Date:	Requestor's Signature/Authorized Agent's Signature:	
DO NOT WRITE IN THIS SECTION		
Location/Unit/Division:		
Email and Phone Number:		
Date Request Received:	Date of Response:	

Response:

- Granted as requested**
- Modified accommodation granted**

Explanation of Modified Accommodation:



**OFFICE OF THE CLERK
OF THE BOARD OF SUPERVISORS**

REGULAR AGENDA REQUEST

Print

MEETING DATE January 18, 2022

Departments: Public Works

TIME REQUIRED

SUBJECT Prop 68 Grant Application for
Mountain Gate Park

**PERSONS
APPEARING
BEFORE THE
BOARD**

AGENDA DESCRIPTION:

(A brief general description of what the Board will hear, discuss, consider, or act upon)

Proposed resolution Approving the Application for Rural Recreation and Tourism Program Grant Funds.

RECOMMENDED ACTION:

Adopt proposed resolution. Provide any desired direction to staff.

FISCAL IMPACT:

No match is required for this project/location. The County has sufficient internal borrowing capacity to provide cash flow for construction of the project as grant reimbursements from the state are periodically received. Future operating and maintenance costs are considered minimal, if any.

CONTACT NAME: Matt Paruolo

PHONE/EMAIL: 760.616.4054 / mparuolo@mono.ca.gov

SEND COPIES TO:

MINUTE ORDER REQUESTED:

YES NO

ATTACHMENTS:

Click to download
Staff Report
Resolution
Sample Contract

History

Time	Who	Approval
1/10/2022 11:55 AM	County Counsel	Yes

1/13/2022 1:41 PM

Finance

Yes

1/14/2022 3:16 PM

County Administrative Office

Yes



MONO COUNTY

DEPARTMENT OF PUBLIC WORKS

POST OFFICE BOX 457 • 74 NORTH SCHOOL STREET • BRIDGEPORT, CALIFORNIA 93517
760.932.5440 • Fax 760.932.5441 • monopw@mono.ca.gov • www.monocounty.ca.gov

Date: January 18, 2021
To: Honorable Chair and Members of the Board of Supervisors
From: Matthew Paruolo, Eastern Sierra Sustainable Recreation Coordinator (ESSRC)
Subject: Proposition 68 – Rural Recreation and Tourism (RRT).

Recommended Action:

Adopt a Resolution to approve submittal of grant funding applications under the California Department of Parks and Recreation Rural Recreation and Tourism Program (RRT).

Fiscal Impact: None, aside from cash-flow needs during the project (prior to reimbursement), and nominal operation and maintenance costs following project completion.

Background: The Rural Recreation and Tourism Program (RRT) is a competitive grant program with \$23 million currently available to fund projects that create new recreation features in support of economic, tourism, and health-related goals. Competitive projects will improve the health of residents and attract out-of-town visitors. Eligible projects must be in a rural location with a population below 500,000 people, or in a city/town/census-designated place that has a population below 50,000 people and create or renovate at least one recreation feature. The renovation of recreation features and support amenities is allowable and cannot exceed fifty percent (50%) of the total project cost to maintain competitiveness. Grant requests per application/project site may range from \$200,000 - \$3,000,000. A match is required only if the project site's area has a median household income above \$56,982 according to the Community Fact Finder Report – no match is required for this project/location.

Discussion: The Department of Public Works and Community Development have worked closely with the National Park Service - Rivers, Trails, and Conservation Assistance Program, and Antelope Valley RPAC to plan improvements to Mountain Gate Park. Staff held community meetings during weekdays and on weekends, as well as providing digital and mail-in surveys to gather insight from community members about their vision for recreation features at the park.

This grant opportunity presents a good opportunity to fund some of the ideas that have grown out of this outreach. The RRT is a good fit for this project in this location and stands to be competitive, although award is not assured.

The application will be for a project up to \$1.65m, which includes a major ecological restoration component covering approximately 20 acres of the Mtn View Fire burn area, a new parking lot, an ADA trail, and an irrigation system to stabilize vegetation.

In authorizing the application, the State requests the Board to confirm that (if the grant is awarded), the County has sufficient resources to complete the project – the County has sufficient internal borrowing capacity to complete (cash flow) the project, pending reimbursement according to the state's guidelines. Also, the state requests the Board confirm the County has sufficient resources to operate and maintain the improvements – since the project is largely restoration, with a parking lot, ADA trail and irrigation system as the infrastructure components, it is not expected to consume a significant amount of operational and maintenance resources and the County has sufficient capacity to operate and maintain the improvements into the future.

The Contract that would be required, should the project be awarded, is also attached to this item.

If you have any questions regarding this item, please contact Matthew Paruolo at mparuolo@mono.ca.gov; 760.616.4054

Respectfully submitted,

Matthew Paruolo, Eastern Sierra Sustainable Recreation Coordinator



R22-__

**A RESOLUTION OF THE MONO COUNTY BOARD OF SUPERVISORS
APPROVING THE APPLICATION FOR
RURAL RECREATION AND TOURISM PROGRAM GRANT FUNDS**

WHEREAS, the State Department of Parks and Recreation has been delegated the responsibility by the Legislature of the State of California for the administration of the Rural Recreation and Tourism Grant Program, setting up necessary procedures governing the application; and

WHEREAS, said procedures established by the State Department of Parks and Recreation require the Applicant to certify by resolution the approval of the application before submission of said application to the State; and

WHEREAS, successful Applicants will enter into a contract with the State of California to complete the Grant Scope project

NOW, THEREFORE, THE BOARD OF SUPERVISORS OF THE COUNTY OF MONO RESOLVES:

The filing of an Application for the Mountain Gate Recreation and Restoration Project is authorized and approved; and

1. Certifies that said Applicant has or will have available, prior to commencement of any work on the project included in this application, the sufficient funds to complete the project; and
2. Certifies that if the project is awarded, the Applicant has or will have sufficient funds to operate and maintain the project, and
3. Certifies that the Applicant has reviewed, understands, and agrees to the General Provisions contained in the contract shown in the Grant Administration Guide; and
4. Delegates the authority to Public Works Director to conduct all negotiations, sign and submit all documents, including, but not limited to applications, agreements, amendments, and payment requests, which may be necessary for the completion of

1 the Grant Scope; and

2 5. Agrees to comply with all applicable federal, state and local laws, ordinances, rules,
3 regulations and guidelines.

4
5 6. Will consider promoting inclusion per Public Resources Code §80001(b)(8 A-G).

6 **PASSED, APPROVED and ADOPTED** this 18th day of January
7 , 2022, by the following vote, to wit:

8 **AYES:**

9 **NOES:**

10 **ABSENT:**

11 **ABSTAIN:**

12
13 _____
14 Bob Gardner, Chair
15 Mono County Board of Supervisors

16 **ATTEST:**

17 **APPROVED AS TO FORM:**

18 _____
19 Clerk of the Board

20 _____
21 County Counsel

Competitive Grant Program Contract



State of California – The Natural Resources Agency
DEPARTMENT OF PARKS AND RECREATION

Sample Grant Contract Competitive Grant Program

GRANTEE: Grantee Name

GRANT PERFORMANCE PERIOD is from July 1, 2019 through June 30, 2024

CONTRACT PERFORMANCE PERIOD is from July 1, 2019 through June 30, 2049

The GRANTEE agrees to the terms and conditions of this contract (CONTRACT), and the State of California, acting through its Director of the Department of Parks and Recreation, pursuant to the State of California, agrees to fund the total State grant amount indicated below.

The GRANTEE agrees to complete the PROJECT SCOPE(s) as defined in the Development PROJECT SCOPE/Cost Estimate Form or acquisition documentation for the application(s) filed with the State of California.

The General and Special Provisions attached are made a part of and incorporated into the Contract.

Total State grant amount not to exceed \$ [GRANT amount]

GRANTEE

AUTHORIZED REPRESENTATIVE Signature Date

Print Name and Title

STATE OF CALIFORNIA
DEPARTMENT OF PARKS AND RECREATION

AUTHORIZED REPRESENTATIVE Signature Date

Print Name and Title

CERTIFICATION OF FUNDING (FOR STATE USE ONLY)					
AMOUNT OF ESTIMATE \$		CONTRACT NUMBER		FUND	
ADJ. INCREASING ENCUMBRANCE \$		APPROPRIATION			
ADJ. DECREASING ENCUMBRANCE \$		ITEM VENDOR NUMBER			
UNENCUMBERED BALANCE \$		LINE ITEM ALLOTMENT		CHAPTER	STATUTE
T.B.A. NO.	B.R. NO.	INDEX		Funding Source	OBJ. EXPEND
I hereby certify upon my personal knowledge that budgeted funds are available for this encumbrance.					
SIGNATURE OF ACCOUNTING OFFICER				DATE	

I. RECITALS

This CONTRACT is entered into between the California Department of Parks and Recreation (hereinafter referred to as “GRANTOR,” “DEPARTMENT” or “STATE”) and [grantee name] (hereinafter referred to as “GRANTEE”).

The DEPARTMENT hereby grants to GRANTEE a sum (also referred to as “GRANT MONIES”) not to exceed \$grant amount, subject to the terms and conditions of this CONTRACT and the 20xx/xx California State Budget, Chapter xx, statutes of 20xx, Item number – 3790-xxx-xxxx (appropriation chapter and budget item number hereinafter referred to as “COMPETITIVE GRANT PROGRAM GRANT”). These funds shall be used for completion of the GRANT SCOPE(S).

The Grant Performance Period is from July 1, 20xx to June 30, 20xx.

II. GENERAL PROVISIONS

A. Definitions

As used in this CONTRACT, the following words shall have the following meanings:

1. The term “ACT” means the California Drought, Water, Parks Climate, Coastal Protection, and Outdoor Access for All Act of 2018, as referred to in section I of this CONTRACT.
2. The term “APPLICATION” means the individual project APPLICATION packet for a project pursuant to the enabling legislation and/or grant program process guide requirements.
3. The term “DEPARTMENT” or “STATE” means the California Department of Parks and Recreation.
4. The term “DEVELOPMENT” means capital improvements to real property by means of, but not limited to, construction, expansion, and/or renovation, of permanent or fixed features of the property.
5. The term “GRANTEE” means the party described as the GRANTEE in Section I of this CONTRACT.
6. The term “GRANT SCOPE” means the items listed in the GRANT SCOPE/Cost Estimate Form found in each of the APPLICATIONS submitted pursuant to this grant.
7. The term “GUIDES” means (1) the document identified as the “Grant Administration Guide for California Drought, Water, Parks, Climate, Coastal Protection, and Outdoor Access For All Act of 2018 Competitive Grant Programs Capital Improvement Projects” and (2) The Application Guide that established the competitive procedures and policies for the selection of projects.

B. Project Execution

1. Subject to the availability of GRANT MONIES in the act, the STATE hereby grants to the GRANTEE a sum of money not to exceed the amount stated in Section I of this CONTRACT, in consideration of, and on condition that, the sum be expended in carrying out the purposes as set forth in the scope described in the enabling legislation and referenced in the APPLICATION, Section I of this CONTRACT, and under the terms and conditions set forth in this CONTRACT.

The GRANTEE shall assume any obligation to furnish any additional funds that may be necessary to complete the GRANT SCOPE(S).

The GRANTEE agrees to submit any change or alteration from the original GRANT SCOPE(S) in writing to the STATE for prior approval. This applies to any and all changes that occur after STATE has approved the APPLICATION. Changes in the GRANT SCOPE(S) must be approved in writing by the STATE.

2. The GRANTEE shall complete the GRANT SCOPE(S) in accordance with the time of the Performance Period set forth in Section I of this CONTRACT, and under the terms and conditions of this contract.

To maintain the integrity of the competitive grant program, the GRANTEE agrees that any other project changes or alterations which deviate from the intent of the project selection criteria provided by the GRANTEE in the original competitive APPLICATION must be submitted in writing to the STATE for prior approval.

3. The GRANTEE shall comply with the California Environmental Quality Act (Public Resources Code, §21000, et seq., Title 14, California Code of Regulations, §15000 et seq.).
4. The GRANTEE shall comply with all applicable current laws and regulations affecting DEVELOPMENT projects, including, but not limited to, legal requirements for construction contracts, building codes, health and safety codes, and laws and codes pertaining to individuals with disabilities, including but not limited to the Americans With Disabilities Act of 1990 (42 U.S.C. §12101 et seq.) and the California Unruh Act (California Civil Code §51 et seq.)

C. Procedural Guide

1. GRANTEE agrees to abide by the GUIDES.
2. GRANTEE acknowledges that STATE may make reasonable changes to its procedures as set forth in the GUIDES. If STATE makes any changes to its procedures and guidelines, STATE agrees to notify GRANTEE within a reasonable time.

D. Project Administration

1. If GRANT MONIES are advanced for DEVELOPMENT projects, the advanced funds shall be placed in an interest bearing account until expended. Interest earned on the advanced funds shall be used on the project as approved by the STATE. If grant monies are advanced and not expended, the unused portion of the grant and any interest earned shall be returned to the STATE within 60 days after project completion or end of the grant performance period, whichever is earlier.
2. The GRANTEE shall submit written project status reports within 30 calendar days after the STATE has made such a request. In any event, the GRANTEE shall provide the STATE a report showing total final project expenditures within 60 days of project completion or the end of the grant performance period, whichever is earlier. The grant performance period is identified in Section I of this CONTRACT.
3. The GRANTEE shall make property or facilities acquired and/or developed pursuant to this contract available for inspection upon request by the STATE.

E. Project Termination

1. Project Termination refers to the non-completion of a GRANT SCOPE. Any grant funds that have not been expended by the GRANTEE shall revert to the STATE.
2. The GRANTEE may unilaterally rescind this CONTRACT at any time prior to the commencement of the project. The commencement of the project means the date of the letter notifying GRANTEE of the award or when the funds are appropriated, whichever is later. After project commencement, this CONTRACT may be rescinded, modified or amended only by mutual agreement in writing between the GRANTEE and the STATE, unless the provisions of this contract provide that mutual agreement is not required.

3. Failure by the GRANTEE to comply with the terms of the (a) GUIDES, (b) any legislation applicable to the ACT, (c) this CONTRACT as well as any other grant contracts, specified or general, that GRANTEE has entered into with STATE, may be cause for suspension of all obligations of the STATE unless the STATE determines that such failure was due to no fault of the GRANTEE. In such case, STATE may reimburse GRANTEE for eligible costs properly incurred in performance of this CONTRACT despite non-performance of the GRANTEE. To qualify for such reimbursement, GRANTEE agrees to mitigate its losses to the best of its ability.
4. Any breach of any term, provision, obligation or requirement of this CONTRACT by the GRANTEE shall be a default of this CONTRACT. In the case of any default by GRANTEE, STATE shall be entitled to all remedies available under law and equity, including but not limited to: a) Specific Performance; b) Return of all GRANT MONIES; c) Payment to the STATE of the fair market value of the project property or the actual sales price, whichever is higher; and d) Payment to the STATE of the costs of enforcement of this CONTRACT, including but not limited to court and arbitration costs, fees, expenses of litigation, and reasonable attorney fees.
5. The GRANTEE and the STATE agree that if the GRANT SCOPE includes DEVELOPMENT, final payment may not be made until the work described in the GRANT SCOPE is complete and the GRANT PROJECT is open to the public.

F. Budget Contingency Clause

If funding for any fiscal year is reduced or deleted by the budget act for purposes of this program, the STATE shall have the option to either cancel this contract with no liability occurring to the STATE, or offer a CONTRACT amendment to GRANTEE to reflect the reduced grant amount. This Paragraph shall not require the mutual agreement as addressed in Paragraph E, provision 2, of this CONTRACT.

G. Hold Harmless

1. The GRANTEE shall waive all claims and recourse against the STATE including the right to contribution for loss or damage to persons or property arising from, growing out of or in any way connected with or incident to this CONTRACT except claims arising from the concurrent or sole negligence of the STATE, its officers, agents, and employees.
2. The GRANTEE shall indemnify, hold harmless and defend the STATE, its officers, agents and employees against any and all claims, demands, damages, costs, expenses or liability costs arising out of the ACQUISITION, DEVELOPMENT, construction, operation or maintenance of the property described as the project which claims, demands or causes of action arise under California Government Code Section 895.2 or otherwise except for liability arising out of the concurrent or sole negligence of the STATE, its officers, agents, or employees.
3. The GRANTEE agrees that in the event the STATE is named as codefendant under the provisions of California Government Code Section 895 et seq., the GRANTEE shall notify the STATE of such fact and shall represent the STATE in the legal action unless the STATE undertakes to represent itself as codefendant in such legal action in which event the GRANTEE agrees to pay the STATE's litigation costs, expenses, and reasonable attorney fees.
4. The GRANTEE and the STATE agree that in the event of judgment entered against the STATE and the GRANTEE because of the concurrent negligence of the STATE and the GRANTEE, their officers, agents, or employees, an apportionment of liability to pay such judgment shall be made by a court of competent jurisdiction. Neither party shall request a jury apportionment.
5. The GRANTEE shall indemnify, hold harmless and defend the STATE, its officers, agents and employees against any and all claims, demands, costs, expenses or liability costs arising out of

legal actions pursuant to items to which the GRANTEE has certified. The GRANTEE acknowledges that it is solely responsible for compliance with items to which it has certified.

H. Financial Records

1. The GRANTEE shall maintain satisfactory financial accounts, documents, including loan documents, and all other records for the project and to make them available to the STATE for auditing at reasonable times. The GRANTEE also agrees to retain such financial accounts, documents and records for five years following project termination or issuance of final payment, whichever is later.
The GRANTEE shall keep such records as the STATE shall prescribe, including records which fully disclose (a) the disposition of the proceeds of STATE funding assistance, (b) the total cost of the project in connection with such assistance that is given or used, (c) the amount and nature of that portion of the project cost supplied by other sources, and (d) any other such records that will facilitate an effective audit.
3. The GRANTEE agrees that the STATE shall have the right to inspect and make copies of any books, records or reports pertaining to this CONTRACT or matters related thereto during regular office hours. The GRANTEE shall maintain and make available for inspection by the STATE accurate records of all of its costs, disbursements and receipts with respect to its activities under this CONTRACT. Such accounts, documents, and records shall be retained by the GRANTEE for at least five years following project termination or issuance of final payment, whichever is later.
4. The GRANTEE shall use a generally accepted accounting system.

I. Use of Facilities

1. The GRANTEE agrees that the GRANTEE shall operate and maintain the property acquired or developed with the GRANT MONIES, for the duration of the Contract Performance Period.
2. The GRANTEE agrees that, during the Contract Performance Period, the GRANTEE shall use the property acquired or developed with GRANT MONIES under this contract only for the purposes of this grant and no other use, sale, or other disposition or change of the use of the property to one not consistent with its purpose shall be permitted except as authorized by the STATE and the property shall be replaced with property of equivalent value and usefulness as determined by the STATE.
2. The property acquired or developed may be transferred to another entity if the successor entity assumes the obligations imposed under this CONTRACT and with the approval of STATE.
3. Any real Property (including any portion of it or any interest in it) may not be used as security for any debt or mitigation, without the written approval of the STATE provided that such approval shall not be unreasonably withheld as long as the purposes for which the Grant was awarded are maintained. Any such permission that is granted does not make the STATE a guarantor or a surety for any debt or mitigation, nor does it waive the STATE'S rights to enforce performance under the Grant CONTRACT.
4. All real property, or rights thereto, acquired with GRANT MONIES shall be subject to an appropriate form of restrictive title, rights, or covenants approved by the STATE. If the project property is taken by use of eminent domain, GRANTEE shall reimburse STATE an amount at least equal to the amount of GRANT MONIES received from STATE or the pro-rated full market value of the real property, including improvements, at the time of sale, whichever is higher.

5. If eminent domain proceedings are initiated against GRANTEE, GRANTEE shall notify STATE within 10 days of receiving the complaint.

J. Nondiscrimination

1. The GRANTEE shall not discriminate against any person on the basis of sex, race, color, national origin, age, religion, ancestry, sexual orientation, or disability in the use of any property or facility developed pursuant to this contract.
2. The GRANTEE shall not discriminate against any person on the basis of residence except to the extent that reasonable differences in admission or other fees may be maintained on the basis of residence and pursuant to law.
3. All facilities shall be open to members of the public generally, except as noted under the special provisions of this project CONTRACT or under provisions of the enabling legislation and/or grant program.

K. Severability

If any provision of this CONTRACT or the application thereof is held invalid, that invalidity shall not affect other provisions or applications of the CONTRACT which can be given effect without the invalid provision or application, and to this end the provisions of this CONTRACT are severable.

L. Liability

1. STATE assumes no responsibility for assuring the safety or standards of construction, site improvements or programs related to the GRANT SCOPE. The STATE'S rights under this CONTRACT to review, inspect and approve the GRANT SCOPE and any final plans of implementation shall not give rise to any warranty or representation that the GRANT SCOPE and any plans or improvements are free from hazards or defects.
2. GRANTEE will secure adequate liability insurance, performance bond, and/or other security necessary to protect the GRANTEE's and STATE'S interest against poor workmanship, fraud, or other potential loss associated with completion of the grant project.

M. Assignability

Without the written consent of the STATE, the GRANTEE'S interest in and responsibilities under this CONTRACT shall not be assignable by the GRANTEE either in whole or in part.

N. Use of Grant Monies

GRANTEE shall not use any grant funds (including any portion thereof) for the purpose of making any leverage loan, pledge, promissory note or similar financial device or transaction, without: 1) the prior written approval of the STATE; and 2) any financial or legal interests created by any such leverage loan, pledge, promissory note or similar financial device or transaction in the project property shall be completely subordinated to this CONTRACT through a Subordination Agreement provided and approved by the STATE, signed by all parties involved in the transaction, and recorded in the County Records against the fee title of the project property.

O. Section Headings

The headings and captions of the various sections of this CONTRACT have been inserted only for the purpose of convenience and are not a part of this CONTRACT and shall not be deemed in any manner to modify, explain, or restrict any of the provisions of this CONTRACT.

P. Waiver

Any failure by a party to enforce its rights under this CONTRACT, in the event of a breach, shall *not* be construed as a waiver of said rights; and the waiver of any breach under this CONTRACT shall *not* be construed as a waiver of any subsequent breach.

GRANTEE

AUTHORIZED REPRESENTATIVE Signature Date

Print Name and Title

STATE OF CALIFORNIA
DEPARTMENT OF PARKS AND RECREATION

AUTHORIZED REPRESENTATIVE Signature Date

Print Name and Title



OFFICE OF THE CLERK
OF THE BOARD OF SUPERVISORS

REGULAR AGENDA REQUEST

Print

MEETING DATE January 18, 2022

Departments: Elections

TIME REQUIRED

**PERSONS
APPEARING
BEFORE THE
BOARD**

Scheereen Dedman

SUBJECT Governor's Proclamation of the June
7, 2022 Statewide Direct Primary
Election

AGENDA DESCRIPTION:

(A brief general description of what the Board will hear, discuss, consider, or act upon)

A proclamation by the Governor of the State of California that the Statewide Direct Primary Election will be held throughout the state on Tuesday, June 7, 2022.

RECOMMENDED ACTION:

FISCAL IMPACT:

CONTACT NAME: Scheereen Dedman

PHONE/EMAIL: 7609325538 / sdedman@mono.ca.gov

SEND COPIES TO:

MINUTE ORDER REQUESTED:

YES NO

ATTACHMENTS:

Click to download

[Proclamation](#)

History

Time	Who	Approval
1/10/2022 11:45 AM	County Counsel	Yes
1/10/2022 5:38 PM	Finance	Yes
1/14/2022 3:15 PM	County Administrative Office	Yes

EXECUTIVE DEPARTMENT
STATE OF CALIFORNIA

A PROCLAMATION
BY THE GOVERNOR OF THE STATE OF CALIFORNIA

I, **GAVIN NEWSOM**, Governor of the State of California, pursuant to California law, including without limitation, sections 10720 and 12000 of the Elections Code, do hereby proclaim and order that a Statewide Direct Primary Election will be held throughout this State on the 7th day of June 2022, at which the following offices are to be filled:

GOVERNOR;

LIEUTENANT GOVERNOR;

SECRETARY OF STATE;

CONTROLLER;

TREASURER;

ATTORNEY GENERAL;

INSURANCE COMMISSIONER;

SUPERINTENDENT OF PUBLIC INSTRUCTION;

MEMBERS OF THE STATE BOARD OF EQUALIZATION from each of the four equalization districts of the State;

UNITED STATES SENATOR (Full Term);

UNITED STATES SENATOR (Partial/Unexpired Term);

REPRESENTATIVES TO THE CONGRESS OF THE UNITED STATES from each of the 52 congressional districts of the State;

STATE SENATORS from even-numbered districts of the 40 senatorial districts of the State;

MEMBERS OF THE ASSEMBLY from each of the 80 assembly districts of the State; and

All such other state, county, judicial, or other officers as are provided by law to be filled at such election.

I further proclaim and order that at such election there will also be submitted to the vote of the electors such proposed constitutional amendments, questions, and propositions as are required to be so submitted by the Constitution and laws of this State.

IN WITNESS WHEREOF I have hereunto set my hand and caused the Great Seal of the State of California to be affixed this 7th day of January 2022.

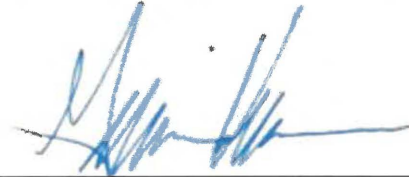

GAVIN NEWSOM
Governor of California

ATTEST:

SHIRLEY N. WEBER, PH.D.
Secretary of State



**OFFICE OF THE CLERK
OF THE BOARD OF SUPERVISORS**

REGULAR AGENDA REQUEST

Print

MEETING DATE January 18, 2022

TIME REQUIRED

SUBJECT

Letter from Range of Light Group
concerning Withdrawal from OVGA
and Fish Slough Wetland

**PERSONS
APPEARING
BEFORE THE
BOARD**

AGENDA DESCRIPTION:

(A brief general description of what the Board will hear, discuss, consider, or act upon)

A letter from the Sierra Club Toiyabe Chapter Range of Light Group discussing concerns over the Fish Slough wetland should Mono County withdraw from the Owens Valley Groundwater Authority (OVGA) Joint Powers Agreement.

RECOMMENDED ACTION:

FISCAL IMPACT:

CONTACT NAME:

PHONE/EMAIL: /

SEND COPIES TO:

MINUTE ORDER REQUESTED:

YES NO

ATTACHMENTS:

Click to download
<input type="checkbox"/> Letter
<input type="checkbox"/> Graph

History

Time	Who	Approval
1/13/2022 1:25 PM	County Counsel	Yes
1/13/2022 1:41 PM	Finance	Yes
1/14/2022 3:15 PM	County Administrative Office	Yes



Range of Light Group
Toiyabe Chapter, Sierra Club
Counties of Inyo and Mono, California
P.O. Box 1973, Mammoth Lakes, CA, 93546
RangeofLight.sc@gmail.com



January 11, 2022

Mono County Board of Supervisors
PO Box 715
Bridgeport, California 93517

RE: Agenda Item 7D-OVGA Withdrawal

Dear Honorable Members of the Mono County Board:

The Sierra Club, the Executive Committee of the Sierra Club Range of Light Group, and our over 400 local members have a deep and longstanding interest in the protection of important wildlands and wildlife in the Eastern Sierra. We write you today about our concerns for Fish Slough should Mono County withdraw its membership from the Owens Valley Groundwater Authority (OVGA) Joint Powers Agreement (JPA). Withdrawing from the JPA will leave Fish Slough, an important wetland, an Area of Critical Environmental Concern, and habitat for endangered species, vulnerable to groundwater declines due to groundwater pumping in Tri-Valley. Most of Fish Slough is in Mono County. Mono County has a responsibility to protect this precious natural resource, especially since declining groundwater levels is threat that can be eliminated.

We would like to make sure the Board is aware of the 2016 [Harrington report](#) that shows the most of the Tri-Valley groundwater is shunted over to Fish Slough and that the 2019 [Zdon, et. al.](#) geochemical study shows that the spring water in Fish Slough comes from Tri-Valley, Adobe Valley, and the Volcanic Tablelands. This and other data described in the OVGA GSP indicates that Tri-Valley is hydrologically connected to and dependent upon groundwater flow from Tri-Valley. The data is now available to the public because of the GSP.

We'd also like to point out that while LADWP's groundwater pumping at wells 385 and 386 did impact Fish Slough, but they have been shut down for decades except for two 60-day pump tests in 1993-94 and 2018-19. There is no other groundwater pumping in the 5 Bridges area and no production groundwater pumping west of Highway 6. The groundwater pumping east of Highway 6 is not impacting Fish Slough because the cone of depression doesn't extend to Fish Slough and there is a north-south fault to the west of Highway 6 that is a groundwater barrier. That narrows the problem to Tri-Valley groundwater pumping.

Per the OVGA GSP, the Tri-Valley groundwater has been declining for the past 30 years and so have the springs and outflow in Fish Slough. The Fish Slough hydrographs show declines in the deep aquifer. The mean annual flow has declined by almost half between 1976 and 2017. The mean annual outflow at the southern end of Fish Slough for the 1967-1976 water year was 6,300 AFY. For 2008-2017 it was 3,400 AFY. Fish Slough spring flow is concerning and the forecast for 2022 is another drought year despite the snow we got in December. Fish Slough is an Area of Critical Environmental Concern and has a few populations of the endangered Owens River pupfish. Mono County needs to help protect Fish Slough.

If Mono County pulls out of the OVGA, then the OVGA won't be able to impose any restrictions on groundwater pumping in the Tri-Valley to protect Fish Slough, impose fees to add monitoring wells, or to develop a model to determine when groundwater pumping in the Tri-Valley is too much. Mono County *should* contribute to these costs. Mono County should want oversight of the groundwater pumping to protect Fish Slough. Declining groundwater levels is a problem that needs to be addressed before we lose the endangered species in Fish Slough. If this problem isn't addressed through the OVGA GSP, then how will it be addressed and when? Without participation in the OVGA, Mono County won't even be aware of the declines and impacts to Fish Slough. The OVGA is the only vehicle for managing the main threat to Fish Slough. This is an opportunity for Mono County to help the Owens River pupfish survive.

For the protection of Fish Slough, we recommend Mono County stay in the OVGA until the County has an alternative in place that regulates groundwater pumping in the Tri-Valley. We ask the County to hold a town hall meeting and present the data that shows how Tri-Valley is impacting Fish Slough.

Thank you,

A handwritten signature in cursive script that reads "Lynn Boulton".

Lynn Boulton,
Chair, Sierra Club Range of Light Group

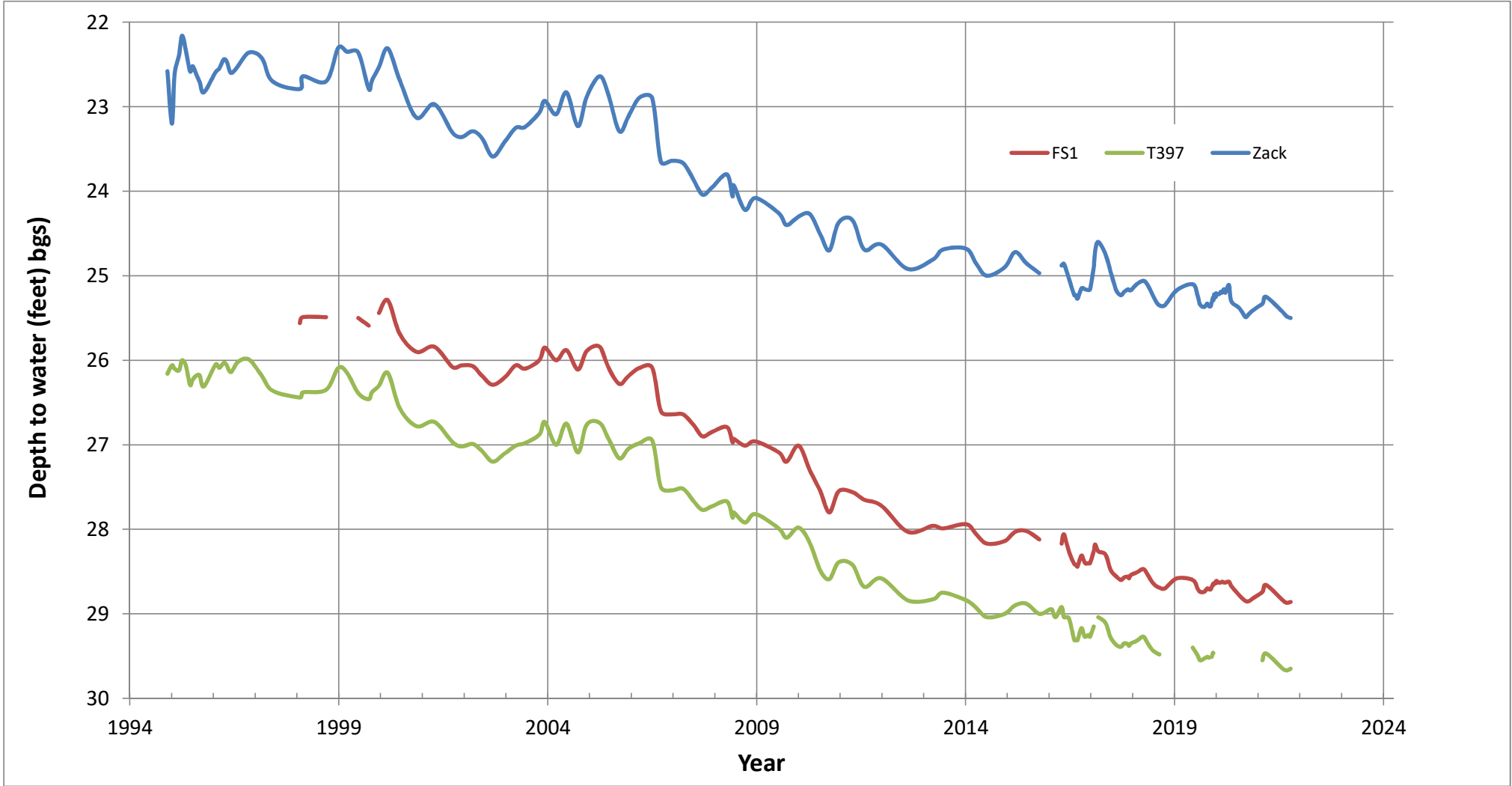



**OFFICE OF THE CLERK
OF THE BOARD OF SUPERVISORS**

REGULAR AGENDA REQUEST

Print

MEETING DATE January 18, 2022

Departments: CAO, Public Health

TIME REQUIRED 15 minutes

SUBJECT COVID-19 (Coronavirus) Update

**PERSONS
APPEARING
BEFORE THE
BOARD**

Robert C. Lawton, CAO, Bryan
Wheeler, Public Health Director, Dr.
Caryn Slack, Public Health Officer

AGENDA DESCRIPTION:

(A brief general description of what the Board will hear, discuss, consider, or act upon)

Update on Countywide response and planning related to the COVID-19 pandemic.

RECOMMENDED ACTION:

None, informational only.

FISCAL IMPACT:

None.

CONTACT NAME: Robert C. Lawton

PHONE/EMAIL: 760-932-5415 / rlawton@mono.ca.gov

SEND COPIES TO:

MINUTE ORDER REQUESTED:

YES NO

ATTACHMENTS:

<p>Click to download</p> <p>No Attachments Available</p>
--

History

Time	Who	Approval
1/10/2022 11:46 AM	County Counsel	Yes
1/6/2022 4:36 PM	Finance	Yes
1/14/2022 3:15 PM	County Administrative Office	Yes



**OFFICE OF THE CLERK
OF THE BOARD OF SUPERVISORS**

REGULAR AGENDA REQUEST

Print

MEETING DATE January 18, 2022

Departments: JEDI

TIME REQUIRED 10 minutes

PERSONS APPEARING BEFORE THE BOARD Scheereen Dedman, JEDI Coordinator

SUBJECT Justice, Equity, Diversity, and Inclusion (JEDI) Update

AGENDA DESCRIPTION:

(A brief general description of what the Board will hear, discuss, consider, or act upon)

Update on the proposed Justice, Equity, Diversity, and Inclusion (JEDI) training plan.

RECOMMENDED ACTION:

None, informational only.

FISCAL IMPACT:

None.

CONTACT NAME: Scheereen Dedman

PHONE/EMAIL: 7609325538 / sdedman@mono.ca.gov

SEND COPIES TO:

MINUTE ORDER REQUESTED:

YES NO

ATTACHMENTS:

Click to download
Staff Report
Implicit Bias Training - Three Phrase Strategy
Resolution 20-93

History

Time	Who	Approval
1/13/2022 1:29 PM	County Counsel	Yes
1/13/2022 1:42 PM	Finance	Yes

1/14/2022 3:15 PM

County Administrative Office

Yes



COUNTY OF MONO

P.O. BOX 696, BRIDGEPORT, CALIFORNIA 93517
(760) 932-5410 • FAX (760) 932-5411

Robert C. Lawton
County Administrative Officer

John Craig
Assistant County Administrator

Date: January 18, 2021

To: Honorable Board of Supervisors

From: Scheereen Dedman, JEDI Coordinator

Re: Update on the Justice, Equity, Diversity, and Inclusion (JEDI) program

RECOMMENDATION:

Receive update on the proposed JEDI training plan. Provide staff direction.

FISCAL IMPACT:

No fiscal impact anticipated at this time. The FY 2021-2022 budget includes funding for the implementation of the Justice, Equity, Diversity, and Inclusion (JEDI) Commission, training program.

DISCUSSION:

Since the last update in July, the county JEDI working group has been meeting monthly to determine ways to meet the Board's goals as set forth in Resolution 20-93, currently focusing our attention on the directives to:

- Study and evaluate existing County policies and practices through a lens of racial equity to promote and support policies that prioritize health in an equitable way.
- Identify specific activities to enhance diversity within the County Government workforce.

The JEDI group has also completed two of the three phases of Implicit Bias Training with Dr. Rita Cameron Wedding, more details of which can be found in the attached updated working plan.

Finally, an application to join the Government Alliance on Race and Equity (GARE) is complete and submitted, awaiting approval.

BACKGROUND ON DR. CAMERON WEDDING:

Dr. Cameron Wedding was the Women's Studies Department Chair at Sacramento State University for 23 years and is currently a professor in the departments of Women's Studies and Ethnic Studies.

As a faculty for the National Council of Juvenile and Family Court Judges (NCJFCJ), she has trained judges at court improvement initiatives in over 40 states.

Dr. Cameron Wedding's curriculum Implicit Bias: Impact on Decision-Making, has been used to train judges, public defenders, practitioners in child welfare, juvenile justice, law enforcement, and education in jurisdictions throughout the United States since 2005.

Dr. Cameron Wedding has conducted implicit bias Train the Trainer Institutes, webinars, and curriculum development in numerous agencies and states throughout the country. Dr. Cameron Wedding's work includes trainings and keynotes on implicit bias for many organizations across the U.S. and the world, including:

- Texas New Judges College
- National Association of Children's Counsel
- Family Court of the Superior Court of the District of Columbia
- Child Abuse and Neglect Institutes in Reno, Louisville, and Atlanta
- New York State Judicial Institute
- Superior Court Judges in Hawaii and Illinois
- Michigan Judges Association

Dr. Cameron Wedding is a presenter for Georgetown University's Center for Juvenile Justice and Reform Conference. She serves on the governing board of Global Majority, an organization dedicated to peace and conflict resolution throughout the world.

Dr. Cameron Wedding is currently developing security officer train-the-trainer curriculum to be taught in various parts of the world for a multi-national technology company.

Attachments:

- Updated Three Phase Strategy-Building an Infrastructure for Race Equity in Mono County
- Resolution R20-93

Implicit Bias: Impact on Decision-Making (Revised 1.6.22)
by Dr. Rita Cameron Wedding

Building Infrastructure for Race Equity in Mono County, California

On October 13, 2020, the Mono County Board of Supervisors unanimously passed, approved, and adopted a “Resolution Recognizing Racism as a Public Health Crisis and Affirming Mono County’s Commitment to Building Racial Equity and Reducing Disparity.”

This historic action seeks to acknowledge the disparities in family stability, health and mental wellness, education, employment, economic development, public safety, criminal justice, and housing associated with racism, and assess internal policies and procedures to ensure racial equity is a core element of the County. Systemic racism has led to deep and persistent racial disparities across all sectors of Mono County.

Systemic Racism is defined as those patterns, procedures, practices, and policies that operate within institutions in ways that intentionally or unintentionally, consistently penalize, and disadvantage individuals who are members of nonwhite racial/ethnic groups. Upon examination, a common characteristic of every public system in the US is its racial disparities, e.g., schools, social services, health care, workforce, law enforcement, housing etc. When there are persistent racial disparities in all public systems, then what we are describing is systemic racism.

The only way to truly intervene against a racist system is to make more informed decisions, at each decision point. Using the implicit bias framework, this proposal will prepare decision-makers to identify and correct individual and institutional practices, patterns, policies and laws which result in inequitable power and systemic discrimination.

Three Phase Strategy-Building an Infrastructure for Race Equity

Phase 1: Introduction to Implicit Bias Training

Participants will receive basic implicit bias training with a focus on understanding how individual and institutional biases and racism impact personal decision-making and institutional outcomes. Participants will conduct an introductory Racial Impact Assessment.

Phase 2: Advanced *Train-the-Trainers*

Participants will receive advanced implicit bias training to reinforce the objectives of Phase 1. In addition, participants will conduct an advanced Racial Impact Assessment to help them identify and locate disparities in public systems, and in particular disparities in service delivery.

Phase 3: Formation of the JEDI Commission

Support the planning and implementation needed to form the JEDI Commission, identify partnerships and key stakeholders needed to establish the JEDI commission. Using the Racial Impact Assessment tool, recommend strategies to fill the gaps to achieve the goals of the JEDI Commission.

Goals and Objective for Building Infrastructure for Race Equity

Phase 1 A. Introduction-Implicit Bias Training

Implicit Bias: Impact on Decision-Making reflects the experiences and expertise of individuals who are practitioners or who have been negatively impacted by racial disproportionality in public systems, e.g., housing, workforce, health care, education, law enforcement, criminal justice, child welfare, probation, etc. This curriculum will explore the impact of implicit bias on decision points within any system that can negatively impact public health outcomes. This curriculum is developed in response to the need to intervene against systemic racism by training decision-makers to recognize, reduce and mitigate racism.

Training Objectives

This core curriculum will focus on how implicit bias, stereotypes, colorblindness and microaggressions and how they systemically affect personal decision-making and distort institutional outcomes with particular impacts on family stability, public safety, housing, employment and education.

Phase 1 B. Introduction -Racial Impact Assessments Objectives

Discretionary decision-making presumed to be based on facts, not bias, can impact outcomes in decision-making without anyone noticing. In order to intervene against biases patterns of bias have to be identified. In this introduction to the Racial Impact Assessment, participants will learn how to identify biases within key departments within the county, e.g., education, law enforcement, public health etc.

The introduction to the Racial Impact Assessment will teach participants how to identify internal policies and procedures of key departments and services, utilizing a Racial Impact Assessment tool to identify and assess biases embedded in the application of policies and their effects on service delivery, outcomes and potential systemic racism.

After Conducting the Introductory Racial Impact Assessment Participants will be able to answer the following questions:

1. Describe the law, policy or practice you are assessing.
2. What conclusions can you draw about the racial impact of the race and ethnic disparities associated with this law/policy or practice?
3. At which decision points do the disparities occur?
4. Are there any identifiable or observable behaviors that reflect racial bias?
5. What is the stated intent of the law or policy?
6. How can policies/practices that appears to be race neutral on the surface be enforced in ways that result in a racial impact?

7. What are some examples of a racial impact?

**Implicit Bias: Impact on Decision-Making
by Dr. Rita Cameron Wedding**

Building Infrastructure for Race Equity in Mono County, California

1/10/22 Phase 2. Building Infrastructure for To Race Equity in Mono County, California

Overview:

Three Phase Strategy-Building an Infrastructure for Race Equity

Phase 1: Introduction to Implicit Bias Training

Participants will receive basic implicit bias training with a focus on understanding how individual and institutional biases and racism impact personal decision-making and institutional outcomes.

Participants will conduct an introductory Racial Impact Assessment. Implicit Bias: Impact on Decision-Making reflects the experiences and expertise of individuals who are practitioners or who have been negatively impacted by racial disproportionality in public systems, e.g., housing, workforce, health care, education, law enforcement, criminal justice, child welfare, probation, etc. This curriculum will explore the impact of implicit bias on decision points within any system that can negatively impact public health outcomes. This curriculum is developed in response to the need to intervene against systemic racism by training decision-makers to recognize, reduce and mitigate racism.

Phase 2: Advanced Train-the-Trainers

Participants will receive advanced implicit bias training to reinforce the objectives of Phase 1. In addition, participants will conduct an advanced Racial Impact Assessment to help them identify and locate disparities in public systems, and in particular disparities in service delivery.

This phase will build upon the Phase I training. In Phase 2 participants will learn more in-depth strategies to interrupt systemic racism.

This training will discuss techniques to guide the work of community stakeholders in mitigating bias through training, facilitation, and community resources. This advanced leadership and implicit bias training will identify and mitigate biases in existing programs; and support system partners in identifying service delivery gaps, by conducting racial impact assessments to explore in-depth, racial discrepancies in the interpretation, enforcement and application of laws, policies, and practices at a particular decision-point (statewide, county) or within an

agency/department. Participants also have the option to develop facilitation and resource expertise.

Phase 2: Objectives:

1. Develop strategies and tools to work collaboratively with agency partners to achieve a shared motivation to reduce bias in decision-making at identified internal and external decision points.
2. Learn how to facilitate difficult dialogues and the skills to intervene in sensitive practices including the differential application and enforcement of agency policies and laws that can contribute to race and ethnic disparities.
3. Develop an action plan for identifying and assessing the racial impact on discretionary decision-making throughout County agencies and departments.

Phase 2: Today's Agenda

2:00-3:45: Overview of Training-Strategies to achieve the objectives of the Resolution.

On October 13, 2020, the Mono County Board of Supervisors unanimously passed, approved, and adopted a *"Resolution Recognizing Racism as a Public Health Crisis and Affirming Mono County's Commitment to Building Racial Equity and Reducing Disparity."*

This historic action seeks to acknowledge the disparities in family stability, health and mental wellness, education, employment, economic development, public safety, criminal justice, and housing associated with racism, and assess internal policies and procedures to ensure racial equity is a core element of the County. Systemic racism has led to deep and persistent racial disparities across all sectors of Mono County.

Introduce three categories of advanced leadership training, e.g., trainers, facilitators, and resource experts. Participants will consider which of these activities will be their focus. (Everyone is invited to participate even if you don't want to be assigned to a specific role.) In addition to learning how to deliver implicit bias training modules, providing facilitation, or becoming resource experts, participants will learn how to facilitate and conduct a racial impact assessment to explore in-depth, racial discrepancies in the interpretation, enforcement and application of laws, policies, and practices at a particular decision-point within the county or within an agency/department.

- Review the results of Phase 1. small group racial impact assessments
- Implications of systemic racism for Mono County-small group activity.

- Addressing systemic racism:
Institutional Racism in the US explained through a Michael Jackson Song (video)
<https://www.youtube.com/watch?v=MdOCyqPcp2o>
Explains the relationship of racism across systems.
- Intersession trainings to prepare participants for *Training-for-Trainers*, facilitators, and resource experts, training for conducting a racial impact assessments and how this work will support the formation of the JEDI Commission.

The Racial Impact Assessment Tool Can Help Participants Identify Biases at Key Decision Points

(Examples of how biases can be identified and assessed)

- How racially coded language as it appears legal documents, leases, rental agreements, personnel documents, medical records, court reports, citations or affidavits.
- How implicit bias can inform “overrides”, risk assessment instruments or decisions in schools, e.g., suspensions or expulsions, law enforcement, e.g., mug shots; or hiring, and promotions within agencies; health care assessments.
- How language is racially coded, e.g., terms like refused services, willful defiance, non-compliant are racially coded or descriptions like ‘poor parenting practices can determine outcomes.
- How the wording in court reports and affidavits can result in ambiguous charges of delinquency and criminality or mental health assessments.
- How bias at one decision-point contributes to bias at subsequent decision-points
- How bias can affect how agency policies are applied and enforced at decision points within a department.

3:45-4:00 Break

4:00-4:30 Small Group Activity: How to move the work forward.

What role do you want to play e.g., trainer, facilitator, or resource specialist? What impact do you want to have, and at what decision-point?

4:30-5:00 Summarize next steps moving to Phase III supporting the formation of the JEDI Commission.

Phase 3 Strategic Support for the Formation of the JEDI Commission

Develop strategic plan to support the formation of the JEDI Commission.

- Constituting the JEDI Commission and seating member representatives across all of Mono County's services and programs.
- (Participants who completed the Phase 2 training will Co-Facilitate Training) implicit bias training to JEDI Commissioners (and associates or organizations). To promote collaborations and partnerships across the county to develop strategies and action plans to address individual and institutional racism county wide.

Objectives: Support the Formation of the JEDI Commission

Phase 3: Formation of the JEDI Commission

Support the planning and implementation needed to form the JEDI Commission, identify partnerships and key stakeholders needed to establish the JEDI commission. Using the Racial Impact Assessment tool, recommend strategies to fill the gaps to achieve the goals of the JEDI Commission.

1. Work with the BOS to develop a workplan to establish the Justice, Equity, Diversity, and Inclusion (JEDI) Commission.
2. Determine the scope of work and timeline for the JEDI Commission.
3. Support the BOS in identifying criteria for service on the Commission, e.g., prioritizing departments and programs that have the greatest impact on public health.
4. Clarify the goals and objectives of the Commission.
5. Identify individual and departmental representation across the County.
6. Identify Commission recruitment strategies and seating of Commissioners.



R20-93

**A RESOLUTION OF THE MONO COUNTY BOARD OF SUPERVISORS
RECOGNIZING RACISM AS A PUBLIC HEALTH CRISIS AND
AFFIRMING MONO COUNTY’S COMMITMENT TO BUILDING
RACIAL EQUITY AND REDUCING DISPARITY**

WHEREAS, throughout our nation’s history, institutional and structural racism and injustice have led to deep and persistent racial disparities across all sectors and have had lasting negative consequences for Mono County; and

WHEREAS, racism results in the structuring of opportunity and assigning of value based solely on skin color and other physical characteristics, which unfairly disadvantages some individuals and communities while providing systemic advantages to other individuals and communities, therefore preventing societies as a whole from achieving their full potential; and

WHEREAS, numerous studies have shown that institutional and structural racism is the root cause of health disparities and social inequities that impact many aspects of life, including housing, education, employment and the economy, public safety and criminal justice, and physical and mental health; and

WHEREAS, Mono County is the current and ancestral homelands of indigenous people, and racist laws, practices, and historic violence have led to the displacement, and in many cases, the death, of indigenous peoples, the suppression of indigenous cultures, languages, and spirituality, and inequities in socioeconomic opportunities and health; and

WHEREAS, the COVID-19 pandemic has disproportionately impacted Latinx residents of Mono County; and

WHEREAS, the May 25, 2020 killing of George Floyd, along with other incidents of police violence, sparked a nationwide movement to address racism and disparity in law enforcement that both the Board of Supervisors and Mono County Sheriff’s Office recognize as legitimate; and

WHEREAS, there is a relationship between health and economic disparities, and thus racism, and global climate change because persons with limited resources are disproportionately affected by extreme weather and deteriorating environmental quality; and

1 **WHEREAS**, on September 15, the Mono County Board of Supervisors, during a
2 presentation titled “Moving Towards Equity,” affirmed the need to recognize racial disparity and
3 to work for equity in county government and our communities.

4 **NOW, THEREFORE, BE IT RESOLVED** that the Board of Supervisors of the County
5 of Mono affirms that racism is a public and mental health crisis that results in disparities in
6 family stability, health and mental wellness, education, employment, economic development,
7 public safety, criminal justice, and housing.

8 **BE IT FURTHER RESOLVED**, that the Mono County Board of Supervisors finds that
9 racism is a public health crisis affecting our entire society, and the Board wishes to assess
10 internal policies and procedures to ensure racial equity is a core element of the County; and

11 **BE IT FURTHER RESOLVED**, that the following actions result from these
12 declarations:

- 13 • The County Administrative Officer and County staff are directed to develop a workplan
14 that includes committing adequate financial resources toward Justice, Equity, Diversity,
15 and Inclusion work, the formation of a Justice, Equity, Diversity, and Inclusion (JEDI)
16 Commission that would guide this effort, recognizing that the burden of education and
17 transformation must not be placed solely on communities of color.
- 18 • Consider County membership in the Government Alliance on Race and Equity (GARE),
19 which is a national network of local government agencies working to achieve racial
20 equity and advance opportunities for all. Membership could include contracting with
21 GARE for training and consulting.
- 22 • Participate in regularly scheduled trainings for the Board of Supervisors and other
23 elected officials, county staff and the public on topics including workplace biases and
24 how to mitigate them, and understanding racism; these trainings should be meaningful,
25 thoughtful, and data-driven education efforts aimed at understanding, addressing, and
26 dismantling racism, and how racism affects public health, family stability, housing, early
27 education, economic development, public safety, and the delivery of human services.
- 28 • Collaborate with the County’s law and justice agencies, NGOs, partner organizations
29 and the community to ensure public confidence that public safety is administered
30 equitably by supporting the Community Advisory Committee recently established by
31 Mono County Sheriff’s Office.
- 32 • Study and evaluate existing County policies and practices through a lens of racial equity
to promote and support policies that prioritize health in an equitable way, especially for
people of color, by mitigating exposure to adverse childhood experiences (ACES) and
promoting healthy, resilient communities.

- 1 • Identify specific activities to enhance diversity within the County Government
2 workforce.
- 3 • Support local, regional, state, and federal initiatives that advance efforts to dismantle
4 systemic racism and reduce inequity.
- 5 • Encourage community participation in efforts to amplify issues of racism and engaging
6 actively and authentically with communities of color throughout the County.
- 7 • Invite other local government agencies, NGOs, and partner organizations in the region
8 to also adopt resolutions affirming that racism is a public health crisis and to work
9 together toward equity.
- 10 • Report back to the board and community starting in January 2021 on these activities,
11 including the formation and seating of the JEDI Commission and a midyear budget
12 adjustment to reflect funding commitment.

13
14 **PASSED, APPROVED and ADOPTED** this 13th day of October 2020, by the
15 following vote, to wit:

16 **AYES:** Supervisors Corless, Gardner, Kreitz, Peters, and Stump.

17 **NOES:** None.

18 **ABSENT:** None.

19 **ABSTAIN:** None.

20
21 

22 Stacy Corless, Chair
23 Mono County Board of Supervisors

24 **ATTEST:**

25 
26 Queenie Barnard (Oct 19, 2020 08:44 PDT)

27 Clerk of the Board

24 **APPROVED AS TO FORM:**

25 
26 Stacey Simon (Oct 19, 2020 08:52 PDT)

27 County Counsel



OFFICE OF THE CLERK
OF THE BOARD OF SUPERVISORS

REGULAR AGENDA REQUEST

Print

MEETING DATE January 18, 2022

Departments: Finance

TIME REQUIRED 1 hour 15 minutes (45 minutes presentation, 30 minutes questions and discussion)

PERSONS APPEARING BEFORE THE BOARD

Janet Dutcher, Finance Director

SUBJECT Workshop - County Retiree Health Care Obligation

AGENDA DESCRIPTION:

(A brief general description of what the Board will hear, discuss, consider, or act upon)

Workshop providing information about the County's Retiree Health Care program, the resulting obligation, status of assets accumulated to pay future retiree health care costs, budgetary impacts, and review of funding policy options.

RECOMMENDED ACTION:

Receive presentation. Discuss future funding policy options. Provide desired direction to staff.

FISCAL IMPACT:

The County's 2021-22 adopted budget includes appropriations of \$1,764,000 to pay retiree health care costs. The County's liability at June 30, 2021 was \$8,241,779, after reduction of \$22,670,568 for accumulated fiduciary trust assets. Explicit future annual retiree health care costs are projected to average \$1,770,419 over the next 15 years, after which annual costs will gradually decline to near \$0 over the next fifty years.

CONTACT NAME: Janet Dutcher

PHONE/EMAIL: 760-932-5494 / jdutcher@mono.ca.gov

SEND COPIES TO:

MINUTE ORDER REQUESTED:

YES NO

ATTACHMENTS:

Click to download
<input type="checkbox"/> Staff report
<input type="checkbox"/> Presentation
<input type="checkbox"/> 2020 Actuarial Valuation - Mono County Retiree Health Care Plan

History

Time	Who	Approval
1/5/2022 9:19 AM	County Counsel	Yes
1/13/2022 12:49 PM	Finance	Yes
1/14/2022 3:17 PM	County Administrative Office	Yes



DEPARTMENT OF FINANCE

AUDITOR-CONTROLLER

COUNTY OF MONO

Kim Bunn
Assistant Finance Director
Auditor-Controller

Janet Dutcher, CPA, CGFM, MPA
Director of Finance

Gerald Frank
Assistant Finance Director
Treasurer - Tax Collector

To: Honorable Board of Supervisors

From: Janet Dutcher, Director of Finance

Date: January 18, 2022

Re: Workshop – County Retiree Health Care Obligation

Today's workshop is designed to explore and understand the County's obligation to pay future retiree health care costs. The County offers employees the continuation of their medical, dental, vision, and life insurance benefits into their retirement years. This promise results in an obligation recently calculated at \$30.9 million.

The County established a post-employment health benefit (OPEB) trust with the Public Agency Retirement Services (PARS). From 2008 through 2019, the County made contributions totaling more than \$13.7 million. Together with investment earnings of nearly \$9 million, the County has accumulated restricted resources of \$22,670,568 as of the measurement date of June 30, 2020 in our plan's most recent actuarial valuation. This equates to a return on investment since inception of the trust of 5.8%. Trust fund resources (or assets) reduce the County's \$30.9 million liability to a net liability of \$8,241,779.

Retiree Health Care Costs and the County's Annual Budget

The County's fiscal year 2020-21 budget includes appropriations charging all departments an aggregated total of \$1,764,000, which is the amount estimated to pay this year's retiree health care cost (i.e., the pay as you go amount). Note that this amount was estimated prior to the start of the current fiscal year and is approximately \$51,000 higher than the amount calculated by the actuarial specialist. To date, no retiree costs have been paid for by drawing down trust fund assets. The most recent actuarial valuation of the County's retiree health care plan calculates the amount needed to prefund future retiree health care costs and extinguish the County's liability by using the actuarially determined contribution (ADC) amount over a remaining amortization period of 17 years beginning with the fiscal year ending June 30, 2022. The ADC has two components. One is equal to the plan's normal cost or the amount attributable to service performed in the current fiscal year. The other component is the amortization of the unfunded actuarial accrued liability or the liability resulting from accumulated prior service that has not been funded.

Budgeted appropriations for retiree health care are show below:

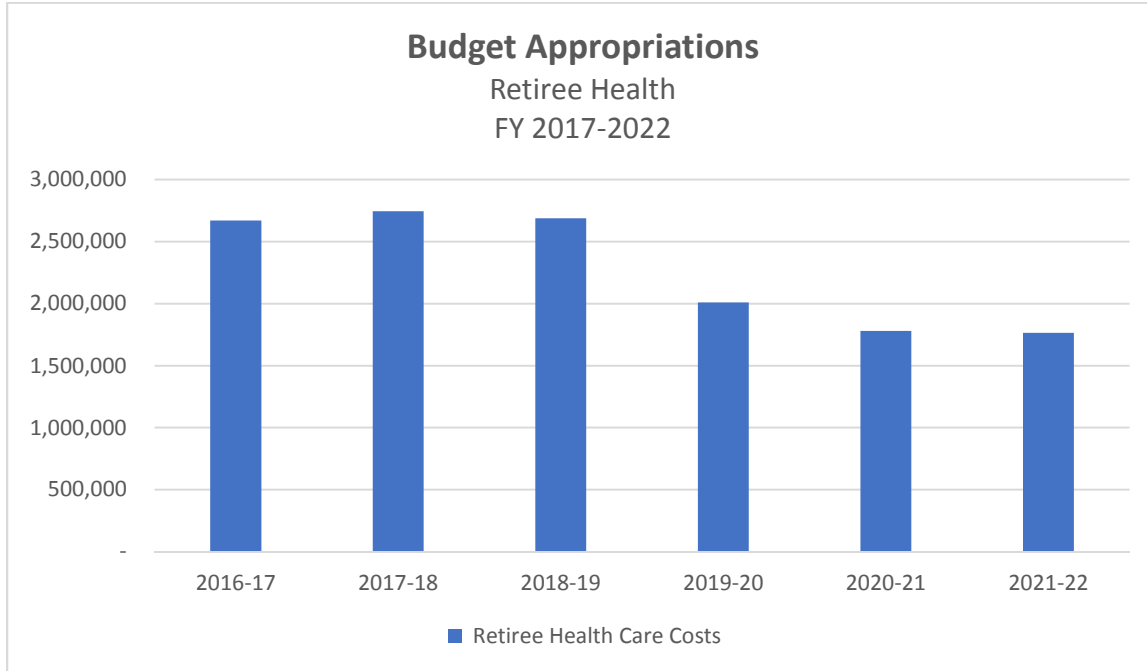

A comparison between the estimated direct payments for retiree costs and the amount actuarially determined to pre-fund all future retiree benefits is shown below:

FISCAL YEAR	ANNUAL RETIREE COSTS (excludes implicit subsidy)	ACTUARIAL DETERMINED CONTRIBUTION (ADC)	EXCESS ADC FUNDING
2020-21	1,643,753	1,177,006	466,747
2021-22	1,712,550	1,097,905	614,645
2022-23	1,728,011	1,006,798	721,213

The above indicates the County has been overfunding its recent annual ADC, resulting in an opportunity, discussed in more detail below, to redirect budgetary savings for other purposes. To further illustrate the financial opportunities available at this juncture, the County could base contributions on the ADC for each of the next 16 years. This would remove the liability from our balance sheet and secure resources to make all future retiree health care costs from the trust fund assets, that requires \$0 budgetary appropriations from other County resources beyond the 16 years of contributions, and assuming all assumptions used to project future benefit liabilities are realized as estimated.

Opportunity to Redirect Budgetary Savings

This provides a unique opportunity to reduce budgetary appropriations by approximately \$757,000 or more in succeeding fiscal years and redirect those resources to paying down other unfunded liabilities such as the County's unfunded pension liability of more than \$67 million ... or to other priority purposes as directed by your Board. A further intriguing thought is the opportunity to reappropriate the entire \$1,764,000 for other purposes 16 years from now. And a balance sheet having no OPEB liability.

Advancing forward another twelve months to June 30, 2021, the PARS trust investments have benefited greatly from the past 18 months of policy decisions by the Federal Reserve. Nationally, investment values have appreciated during a period of low interest rates and stimulus payments designed to ensure the U.S. economy recovers. During this period, the PARS balance grew by \$6.1 million, or about 27%, to a balance of \$28,778,790, as of November 30, 2021. PARS representatives are reporting fund performance of 7.1% since inception of the account. With all other factors being equal, these recent investment earnings would reduce the County's net liability from \$8.2 million down to \$2.1 million. And further assuming the American economy remains strong and trust fund investments continue earning between 5% and 6% per year on average, future earnings on the current trust fund balance may be sufficient to cover the County's average annual retiree health care costs for the next fifteen years without spending down its principal. But this premise includes a lot of "if"s.

Scenario Testing

The actuarial valuation report refers to "trust sufficiency", emphasizing that trust fund contributions on a pre-funding basis should be no less than the amount which is projected for paying all future benefit payments, based on current plan provisions and the valuation assumptions. Doing so means that the valuation can use the trust rate return on investment as the discount rate instead of the 20-year, tax-exempt general obligation municipal bond rate having a rating of AA/Aa or higher (1.55% to 1.75%). For discussion purposes, the Net OPEB liability would increase by nearly \$5.2 million with a one percentage drop in the discount rate from 5.8% to 4.8%. Being forced to use a discount rate ranging from 1.5% to 7.75% is sure to increase the liability by tens of millions of dollars. Therefore, maintaining trust fund sufficiency to pay future benefit payments is of financial importance.

The actuarial valuation includes a projection of future benefit payments (covering the next 60 years) and is presented below:

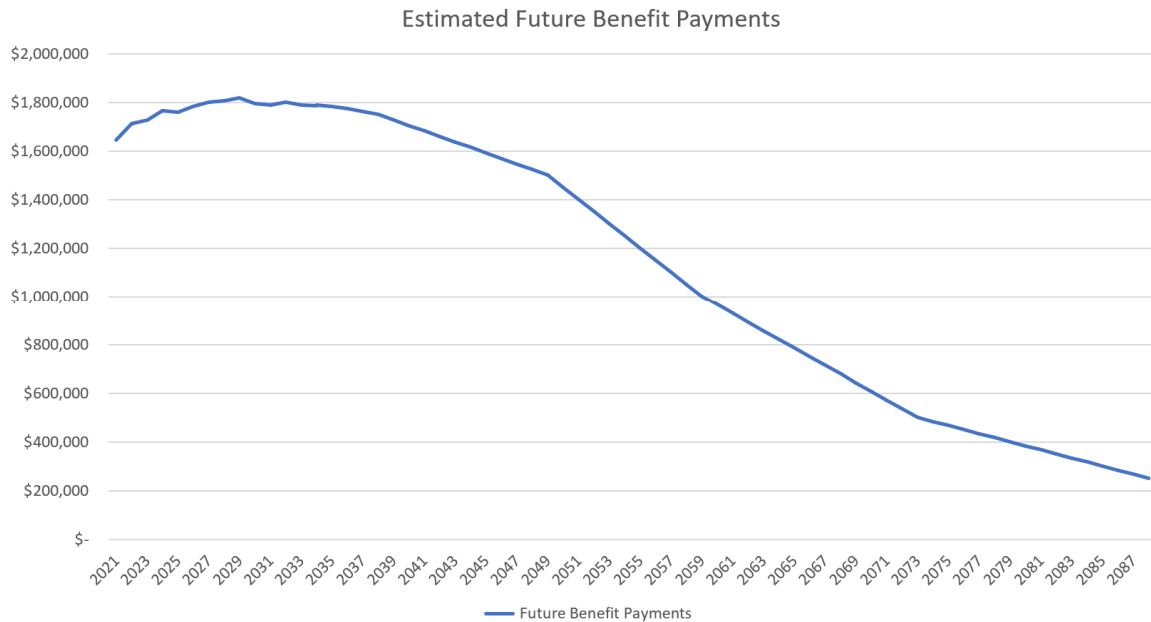

Knowing the anticipated disbursement of benefit payments for the next 60 years and the current trust fund assets available to finance these payments, scenarios of varying contribution arrangements at set investment earnings rates can be formulated. This helps inform future policy decisions about how much budgetary resources to dedicate towards retiree health care appropriations.

Scenario #1: plan assets earn a constant 5% investment return, all benefit payments are made using trust fund assets, and the County makes no further contributions to the trust

This scenario results in insufficient resources to pay retiree health care costs, ending with an accumulated deficit exceeding \$60 million, as illustrated below. This scenario is not advisable.

Plan Assets – 5% Earnings Rate and Make benefit payments from 115 Trust?

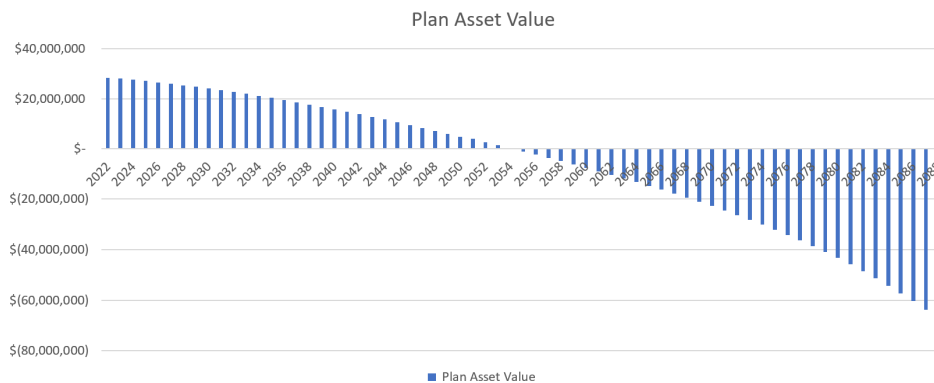

Scenario #2: plan assets earn a constant 6% investment return, all benefit payments are made using trust fund assets, and the County makes no further contributions to the trust

This scenario results in sufficient resources to pay retiree health care costs. The lowest trust fund balance is slightly less than \$20 million and accumulates to about \$50.5 million after 60 years, as illustrated below. While this scenario is encouraging, it is also risky. It is uncertain the plan assets can sustain a constant rate of return of 6% over 60 years, which is a very long period. Likewise, this scenario is not advisable.

Plan Assets – 6% Earnings Rate and Make benefit payments from 115 Trust?

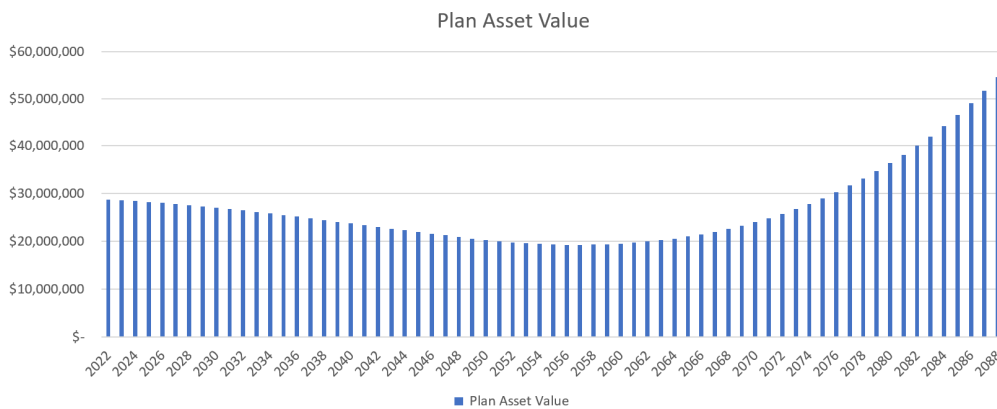

These two scenarios were performed to illustrate the County needs to make some level of contribution to the plan and that the County has not yet reached a point where trust fund assets are sufficient to pay all future benefits without making some level of contribution.

Scenario #3: plan assets earn a constant 5% investment return, all benefit payments are made using trust fund assets, and the County makes \$250,000 annual contributions for 16 years

This scenario was chosen because it represents the least amount the County should contribute over the remaining unamortized 30-year closed period for paying down the unfunded liability. The results of this scenario show that the plan asset value over the next 60 years would be just sufficient to pay all future benefit payments, see illustration below.

Plan Assets – 5% Earnings Rate, Amortized Contributions, and Make benefit payments from 115 Trust?

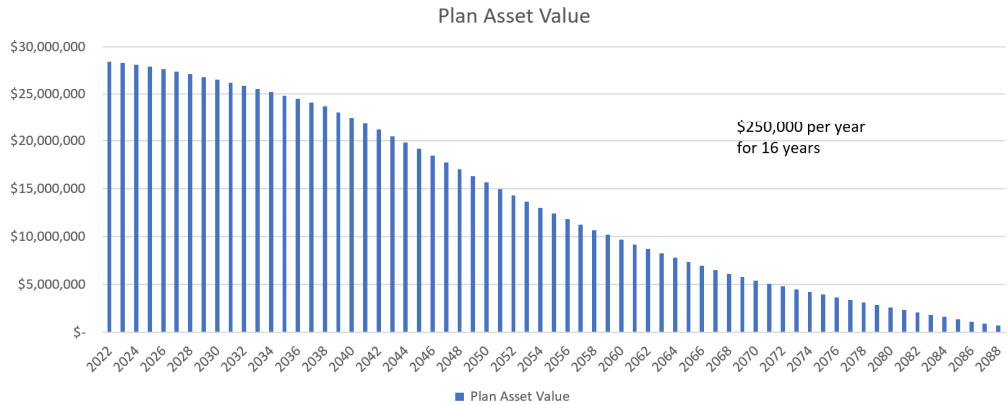

But this assumes a constant 5% rate of return, an assumption that cannot be guaranteed. It also assumes that future medical premiums will increase by no more than 5.7% but CalPERS increased premiums by more than 10% between 2021 and 2022. We also cannot guarantee estimates about mortality, retirement age, and length of service. It would be advisable to take a conservative position about future contributions and re-evaluate that decision on a frequent basis.

Potential Policy Questions

Below are some policy questions to consider. Future agenda items will explore answers to these questions and pose financing tools that incorporate these decisions with funding the pension obligation.

Should the County consider paying more or all its future annual retiree health care costs from trust fund assets?

Should the County reduce its annual budgetary appropriations for future annual retiree health care costs to the prefunding amount of \$1 million or less per year?

To what use should the County invest budget savings should either of the alternatives suggested above be chosen?

These are challenging questions to answer. And the consequences resulting from policy choices are certain to be significant.

The objective of today’s workshop is to understand this program by:

- Describing the Mono County retiree health care program
- Reviewing current and future projected demographics
- Explaining the resulting obligation to pay future retiree health care costs
- Discussing the status of assets accumulated to pay future retiree health care costs

- Exploring anticipated future budgetary impacts
- Discussing policy options, consequences and staff recommendation for consideration

The ultimate objective is adoption of retiree health care and pension funding policies, laying the framework for addressing the County's fiscal concerns over these unfunded liabilities.

Mono County Retiree Health Care Obligation

Workshop January 18, 2022

Workshop Topics

- Definitions
- Plan Description
- Demographics
- Valuation Assumptions
- Net OPEB Liability
- Illustrative Scenarios and Policy Options
- Net Steps

DEFINITIONS

Understanding the “Lingo”

January 18, 2022 Board of Supervisors Meeting

Glossary

Actuarial Funding Method – A procedure which calculates the actuarial present value of plan benefits and expenses, and allocates these expenses to time periods, typically as a normal cost and an actuarial accrued liability

Actuarial Present Value of Projected Benefits (APVPB) – The amount presently required to fund all projected plan benefits in the future. This value is determined by discounting the future payments by an appropriate interest rate and the probability of nonpayment.

CalPERS – Many state governments maintain a public employee retirement system; CalPERS is the California program, covering all eligible state government employees as well as other employees of other governments within California who have elected to join the system

Defined Benefit (DB) – A pension or OPEB plan which defines the monthly income or other benefit which the plan member receives at or after separation from employment

Deferred Contributions – When an employer makes contributions after the measurement date and prior to the fiscal year end, recognition of these contributions is deferred to a subsequent accounting period by creating a deferred resource. We refer to these contributions as Deferred Contributions.

Defined Contribution (DC) – A pension or OPEB plan which establishes an individual account for each member and specifies how contributions to each active member’s account are determined and the terms of distribution of the account after separation from employment

Discount Rate - Interest rate used to discount future potential benefit payments to the valuation date. Under GASB 75, if a plan is prefunded, then the discount rate is equal to the expected trust return. If a plan is not prefunded (pay-as-you-go), then the rate of return is based on a yield or index rate for 20-year, tax-exempt general obligation municipal bonds with an average rating of AA/Aa or higher.

Expected Average Remaining Service Lifetime (EARSL) – Average of the expected remaining service lives of all employees that are provided with benefits through the OPEB plan (active employees and inactive employees), beginning in the current period

Entry Age Actuarial Cost Method – An actuarial funding method where, for each individual, the actuarial present value of benefits is levelly spread over the individual’s projected earnings or service from entry age to the last age at which benefits can be paid

Excise Tax – The Affordable Care Act created an excise tax on the value of employer sponsored coverage which exceeds certain thresholds (“Cadillac Plans”). This tax was repealed in December 2019, before ever going into effect.

Explicit Subsidy – The projected dollar value of future retiree healthcare costs expected to be paid directly by the Employer, e.g., the Employer’s payment of all or a portion of the monthly retiree premium billed by the insurer for the retiree’s coverage

Fiduciary Net Position – The value of trust assets used to offset the Total OPEB Liability to determine the Net OPEB Liability.

Government Accounting Standards Board (GASB) – A private, not-for-profit organization which develops generally accepted accounting principles (GAAP) for U.S. state and local governments; like FASB, it is part of the Financial Accounting Foundation (FAF), which funds each organization and selects the members of each board



- **OPEB / Retiree Health Care Plan**

- Benefits other than pension benefits
- For retirees (and beneficiaries) from retirement date to death
- County provides (and pays) ...
 - Medical insurance & Medicare Supplemental Premium
 - Dental Insurance premium
 - Vision premium
 - Life Insurance

- **OPEB Section 115 Trust**

- Irrevocable trust owning assets solely for paying future OPEB costs
- County makes contributions
- Fiduciary decisions about LT investment of assets
- County established PARS trust fund in 2008. Balance at Nov 2021 = \$28,768,000

- **Discount Rate**

- Interest rate used to discount annual future plan costs
- Affects calculation of OPEB liability (low rate = high liability)

- **Pay-As-You-Go (PAYGO)**

- Contributions equal only to the anticipated plan costs for the year
- No additional contributions for future plan costs or unfunded past service costs
- Results in lower discount rate (20-year tax exempt security = 1%)
- Operating budget bears burden of higher appropriations in later years

- **Pre-Funding**

- Setting aside funds to accumulate in an irrevocable OPEB trust
- Results in higher discount rate (expected trust return = 6%)
- Ability to flatten/smooth impact to operating budget appropriations
- Better intergenerational taxpayer equity (matching costs with service years)

- **PEMHCA**

- Public Employees' Medical and Hospital Care Act
- Participating employers pay the minimum amount towards employee premium for both retirees and actives participating in plan
- 2022 = \$149 per month per participant (200 projected retirees = \$358,000/yr)

- **Actuarial Present Value of Projected Benefits**
 - Amount required today to fund all future benefit payments, at a certain discount rate
- **OPEB Liability**
 - Share of the Actuarial Present Value of Projected Benefits that vest benefit rights with employees
- **Fiduciary Net Position**
 - Value of trust assets
 - Reduces OPEB Liability to the Net OPEB Liability
- **Explicit Subsidy**
 - Future amount of retiree healthcare costs
 - Paid by employer (excludes amount paid by retiree)
- **Implicit Subsidy**
 - Difference between retiree health bills and retiree premiums
 - Retirees participating in plan that includes actives and retirees
 - Retiree premium is lower than would be if paid outside the plan
 - Results because of “group premium” pricing structures

- **Normal Costs**

- Value of benefits a current employee earns by working one year

- **Unfunded Accrued Liability (UAL)**

- Prior year normal costs that have not been funded

- **Annual Required Contribution (ARC)**

- Amortization payment plan for paying off the unfunded liability
 - 30 year closed on a level dollar basis of payroll costs (17 years remain)
- Plus the current FY normal costs

- **Expected Annual Benefit Payments**

- Amount County expects to pay for its commitment towards paying retiree medical premiums
- Includes implicit subsidy to retirees who obtain lower insurance rates than they could otherwise outside the plan

MONO COUNTY PLAN DESCRIPTION

Section 2A - Summary of Retiree Benefit Provisions

Current premium rates: The 2021 CalPERS monthly medical plan rates in the Region 1 rate group are shown in the table below. If different rates apply where the member resides outside of this area, those rates are reflected in the valuation, but not listed here. The CalPERS administration fee is assumed to be expensed each year and has not been projected as an OPEB liability in this valuation:

Region 1 2021 Health Plan Rates						
Plan	Actives and Pre-Med Retirees			Medicare Eligible Retirees		
	Ee Only	Ee & 1	Ee & 2+	Ee Only	Ee & 1	Ee & 2+*
Kaiser HMO	\$ 813.64	\$ 1,627.28	\$ 2,115.46	\$ 324.48	\$ 648.96	\$ 1,137.14
PERS Choice PPO	935.84	1,871.68	2,433.18	349.97	699.94	1,261.44
PERS Select PPO	566.67	1,133.34	1,473.34	349.97	699.94	1,039.94
PERSCare PPO	1,294.69	2,589.38	3,366.19	381.25	762.50	1,539.31
PORAC Region 1	799.00	1,725.00	2,199.00	513.00	1,022.00	1,496.00

* Rates shown in this column reflect 2 parties on Medicare and 1 party pre-Medicare

RETIREE BENEFIT PROVISIONS

- Defined benefit plan: predetermined benefit during retirement years, from retirement date to date of death
- County paid portion varies based on Union MOU Contracts
- Benefit provisions include
 - Medical insurance offered thru CalPERS
 - Dental insurance
 - Vision insurance
 - Life Insurance
- Retirement criteria - receiving pension retirement payments from Mono County's pension plan(s)

ENHANCED VS NON- ENHANCED BENEFITS

- **Enhanced benefits**

- Hired prior to January 1, 2002
- 5 to 20 years continuous service, depending on hire date
- Retiree plus one or more dependents
- County pays insurance premium minus pre-determined cost share amount (ie..5%, depending on MOU provisions at retirement)

A. Retirees

Retirees who enroll in CalPERS medical insurance shall receive the statutory amount prescribed by Government Code section 22892 per month, which shall be paid directly by the County to PERS.

- **Non-Enhanced benefits**

- Privilege of participation in County's CalPERS medical insurance plan
- County pays PEMHCA (\$149/month)
- Retiree pays the remainder

DEMOGRAPHICS

January 18, 2022 Board of Supervisors Meeting

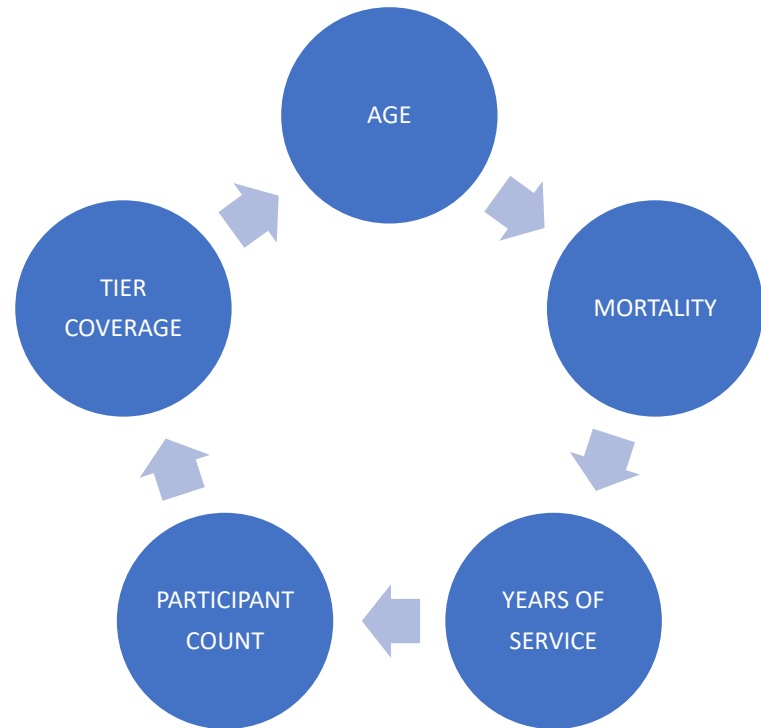

ACTIVE ELIGIBLE
EMPLOYEES
As of June 2020

Distribution of Benefits-Eligible Active Employees								
Current Age	Years of Service						Total	Percent
	Under 1	1 to 4	5 to 9	10 to 14	15 to 19	20 & Up		
Under 25	2	1					3	1%
25 to 29	13	13	4	1			31	11%
30 to 34	6	23	15	3			47	16%
35 to 39	8	16	10	9	6		49	17%
40 to 44	6	11	6	10	6	1	40	14%
45 to 49		7	6	8	5	5	31	11%
50 to 54	2	7	5	6	5	9	34	12%
55 to 59	1	8	2	11	5	8	35	12%
60 to 64	3	2	3	4	4	2	18	6%
65 to 69		1		1	1	2	5	2%
70 & Up							0	0%
Total	41	89	51	53	32	27	293	100%
Percent	14%	30%	17%	18%	11%	9%	100%	

Valuation	June 2018	June 2020
Average Attained Age for Actives	44.4	43.4
Average Years of Service	9.2	8.4

RETIREEES

As of June 2020

Retirees by Age				
Current Age	PEMHCA Minimum Benefit	Enhanced Benefit	Total	Percent
Below 50	0	0	0	0%
50 to 54	0	2	2	1%
55 to 59	5	7	12	6%
60 to 64	10	17	27	14%
65 to 69	10	25	35	19%
70 to 74	9	38	47	25%
75 to 79	5	20	25	13%
80 & up	3	38	41	22%
Total	42	147	189	100%
Average Age:				
On 6/30/2020	68.9	73.9	72.8	
At retirement	59.9	56.2	57.1	

SUMMARY OF PLAN MEMBER COUNTS

Summary of Plan Member Counts	
Number of active plan members	293
Number of inactive plan members currently receiving benefits	189
Number of inactive plan members entitled to but not receiving benefits	91

ASSUMPTIONS

Plan experience and best estimate of expected future outcomes

January 18, 2022 Board of Supervisors Meeting

Actuarial assumptions – The total OPEB liability in the June 30, 2018 actuarial valuation was determined using the following actuarial assumptions:

Valuation date	June 30, 2018
Measurement date	June 30, 2019
Actuarial assumptions:	
Discount rate	6.00%
Inflation	2.75%
Investment rate of return	6.00%
Salary increases	3.25%

Mortality	Based on the 2017 CalPERS experience study using data from 1997 to 2015, except for a different basis used to project future mortality improvements. The representative mortality rates were those published by CalPERS adjusted to back out 15 years of Scale MP 2016 to central year 2015. The mortality improvement is estimated using the MacLeod Watts Scale 2018 applied generationally from 2015.
Participation rate	Active employees: 100% are assumed to continue their current plan election in retirement, if eligible for benefits greater than the PEMHCA minimum. If eligible only for the PEMHCA minimum benefit, it is assumed 50% will elect coverage in retirement. If not currently enrolled, it is assumed the employee would elect coverage in the PERS Choice Other Northern CA region plan at or before retirement. Retired participants: Existing medical plan elections are assumed to be continued until the retiree's death.
Healthcare cost trends	Medical plan premiums and claims costs by age are assumed to increase once each year. Increases over the prior year's levels are assumed as follows: 2020, 7%; 2021, 6.50%; 2022, 6.0%; 2023, 5.50%; 2024 & later, 5.00%. The PEMHCA minimum employer contribution and dental and vision premiums are all assumed to increase by 4.0% per year.

ECONOMIC ASSUMPTIONS

- Discount rate – 5.8% (return on trust assets since inception)
- Inflation – 2.5% per year
- PEMHCA, dental, vision – 4% per year
- Healthcare cost trends – Getzen Model 2021_b published by the Society of Actuaries

Effective January 1	Premium Increase	Effective January 1	Premium Increase
2021	Actual	2061-2066	4.8%
2022	5.7%	2067	4.7%
2023	5.6%	2068	4.6%
2024	5.5%	2069	4.5%
2025-2026	5.4%	2070-2071	4.4%
2027-2029	5.3%	2072	4.3%
2030-2051	5.2%	2073-2074	4.2%
2052	5.1%	2075	4.1%
2053-2055	5.0%	2076	4.0%
2056-2060	4.9%	& later	4.0%

Participant Decisions and Demographic Assumptions

- Retiree chooses to continue participating in the County's CalPERS medical insurance plan?
 - If eligible for enhanced benefits: 100% of active employees
 - If NOT eligible for enhanced benefits: 50% - 30% of active employees
- Spousal and dependent coverage
- Mortality rates
- Retirement age (service retirement rates)
- Will employee leave County employment prior to retirement?

NET OPEB LIABILITY

*Present Value Obligation
beyond accumulated
resources held in trust*

January 18, 2022 Board of Supervisors
Meeting

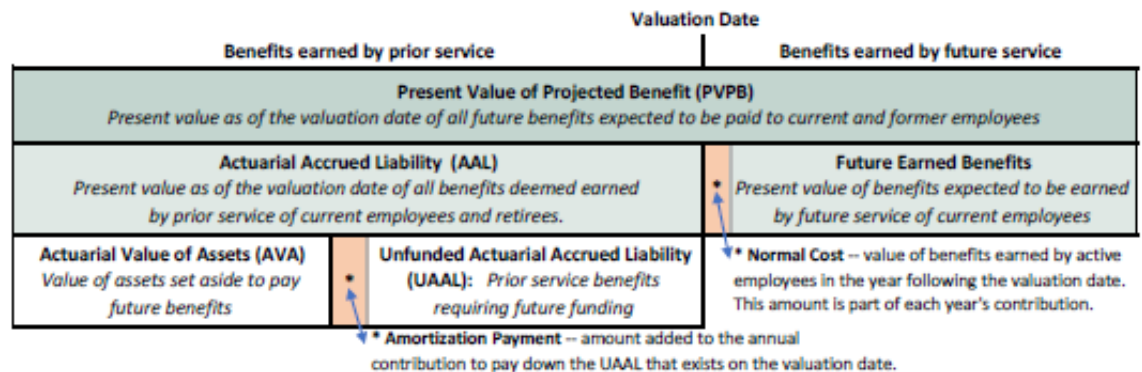

Valuation Date	1/1/2014	1/1/2016	6/30/2018	6/30/2020
Fiscal Year Ending	6/30/2016	6/30/2018	6/30/2019	6/30/2021
Discount Rate		6.25%	6.0%	5.8%
Covered Employees				
Active	263	252	275	293***
Retired	181	176	191	189
Total	444	428	466	482
Total OPEB Liability	\$25,894,516	\$33,863,468	\$31,054,583	\$30,912,347
Trust Assets (Fiduciary Net Position)	\$11,907,624	\$14,369,915	\$22,015,762	\$22,670,568
Net OPEB Liability	\$13,986,892	\$19,493,553	\$9,038,821	\$8,241,779
Funded Status	45.99%	42.43%	70.89%	73.33%*
Annual Required Contribution	\$1,501,197	\$2,064,918	\$1,380,860	\$1,177,006
Expected Annual Benefit Payments**	\$1,443,810	\$1,986,467	\$1,656,302	\$1,643,753

* Current Trust Assets are valued at \$28,768,000. Assuming the Trust OPEB Liability does not increase, funded status would be 93.06%

** Excludes Implicit Subsidy share to account for retiree insurance premiums lower than would be if enrolled outside the County's health care plan

***Maximum of 23 Employees of the 293 current active employees are potentially eligible for enhanced retiree health care benefits

Liability vs. Plan Assets vs. Discount Rate



Fiduciary Plan Assets
(115 Trust with PARS)
As of June 30

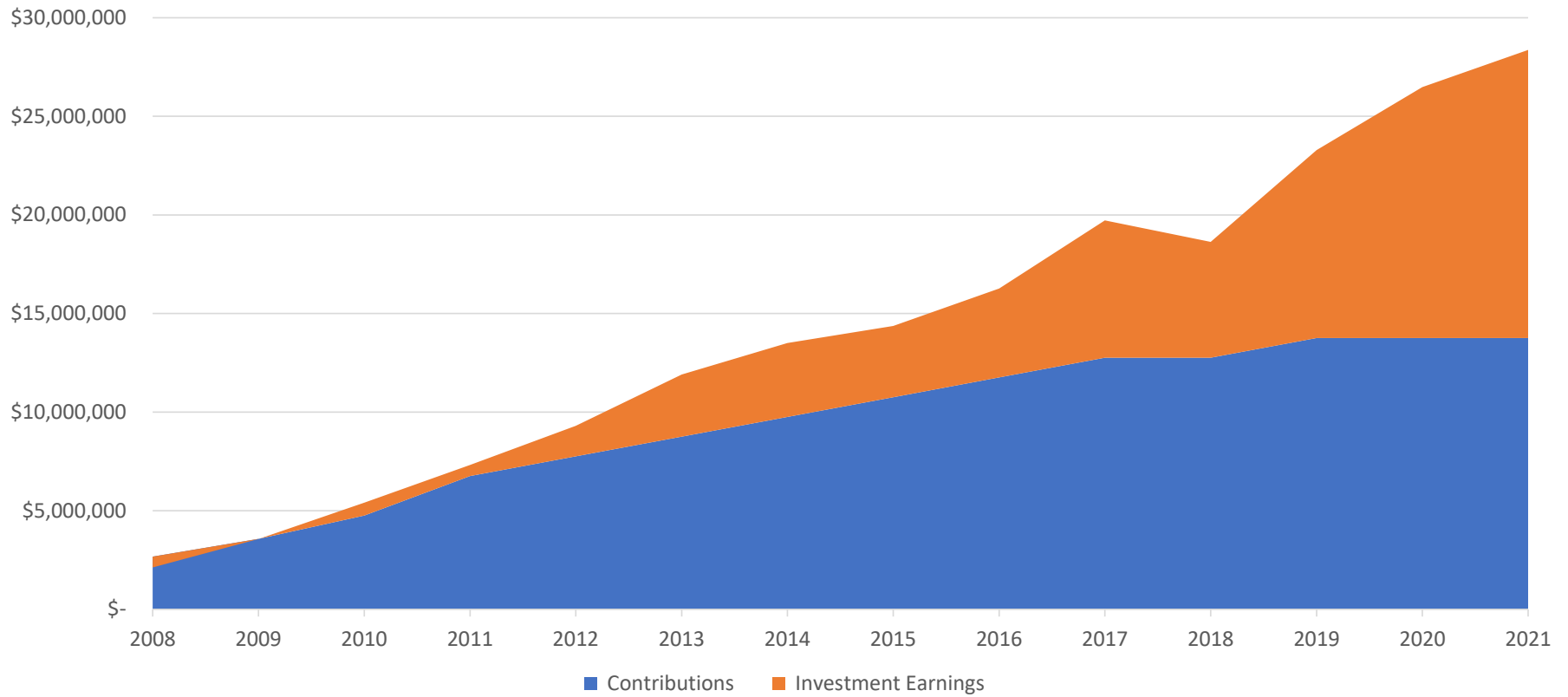

Estimated Future Benefit Payments

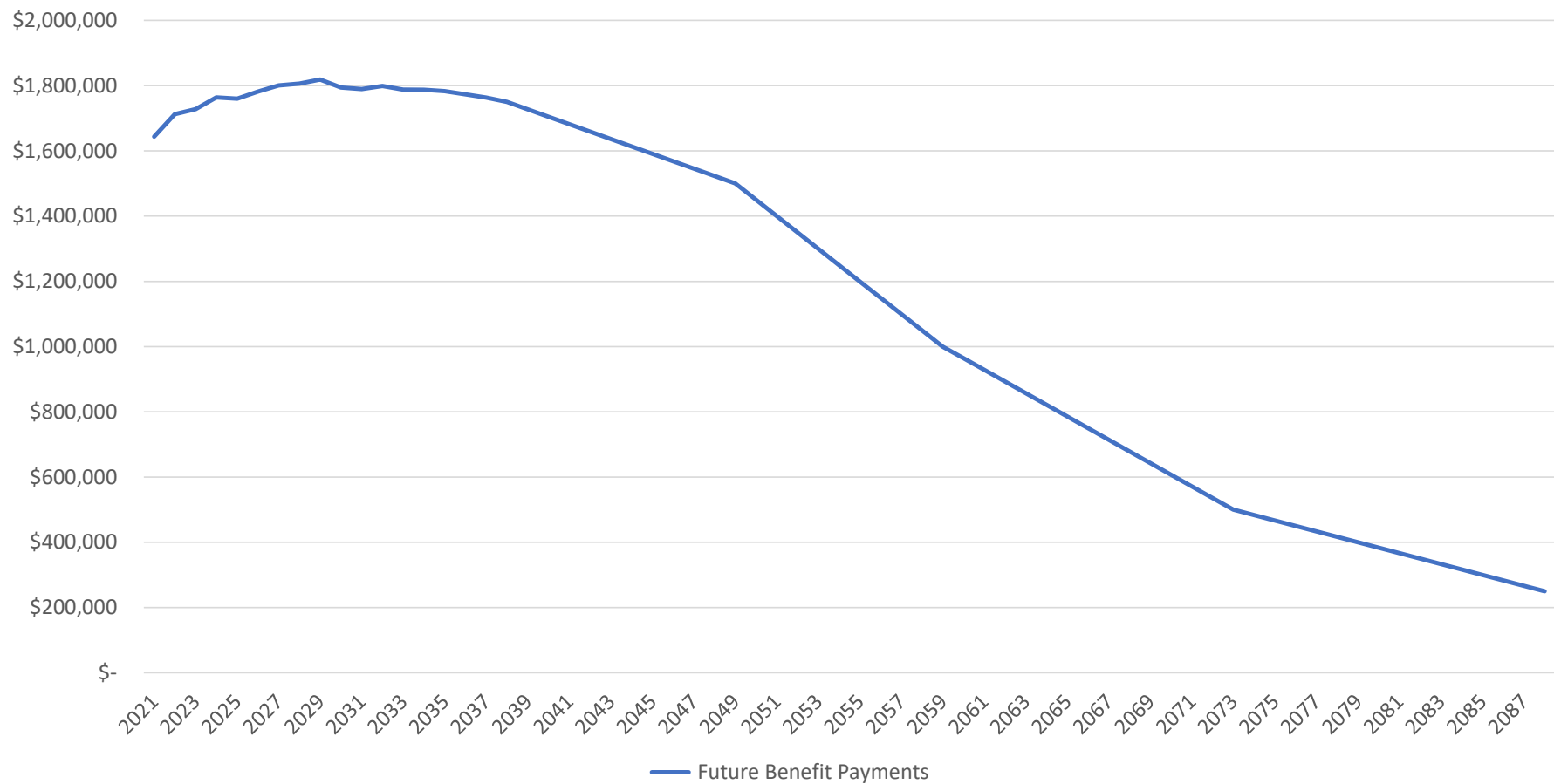

SCENARIOS

1. Pay 100% benefits from trust and trust earns 5%
2. Pay 100% benefits from trust and trust earns 6%
3. Pay 100% benefits from trust, make amortized contributions, trust earns 5%

Plan Assets – 5% Earnings Rate and Make benefit payments from 115 Trust?

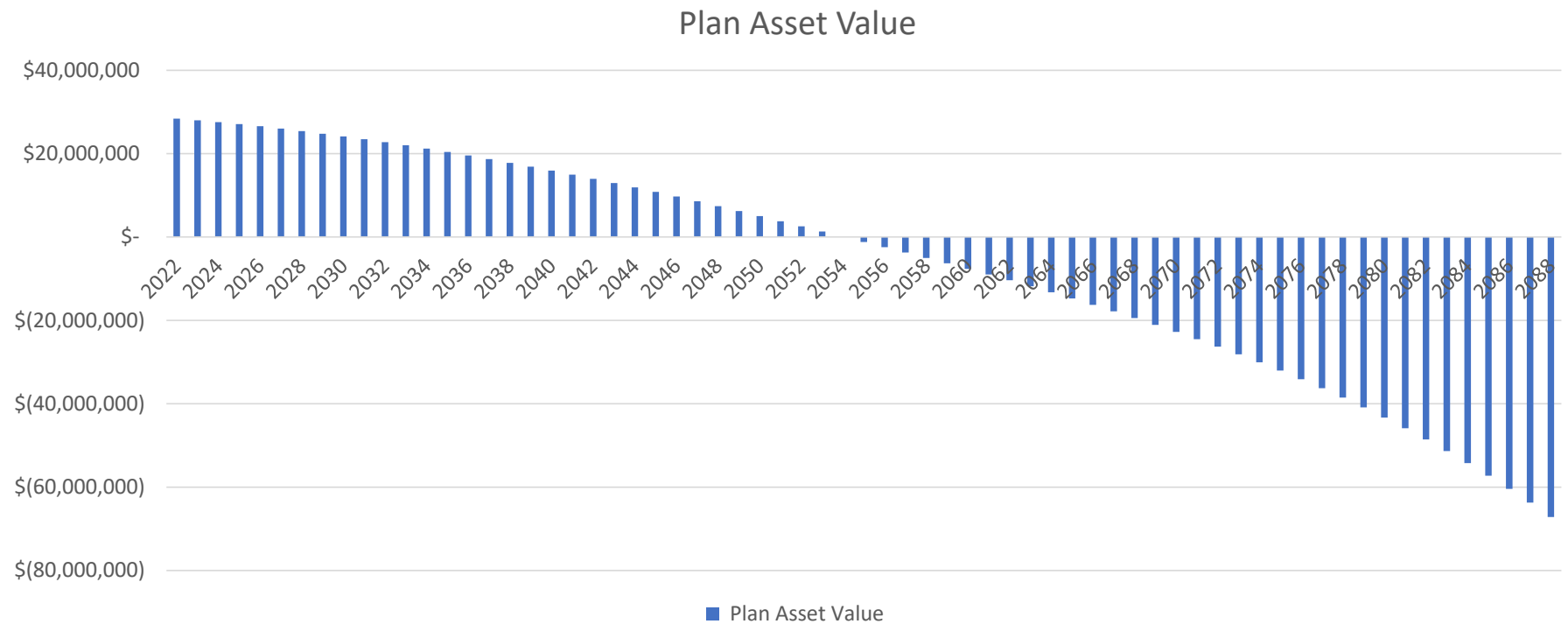

Plan Assets – 6% Earnings Rate and Make benefit payments from 115 Trust?

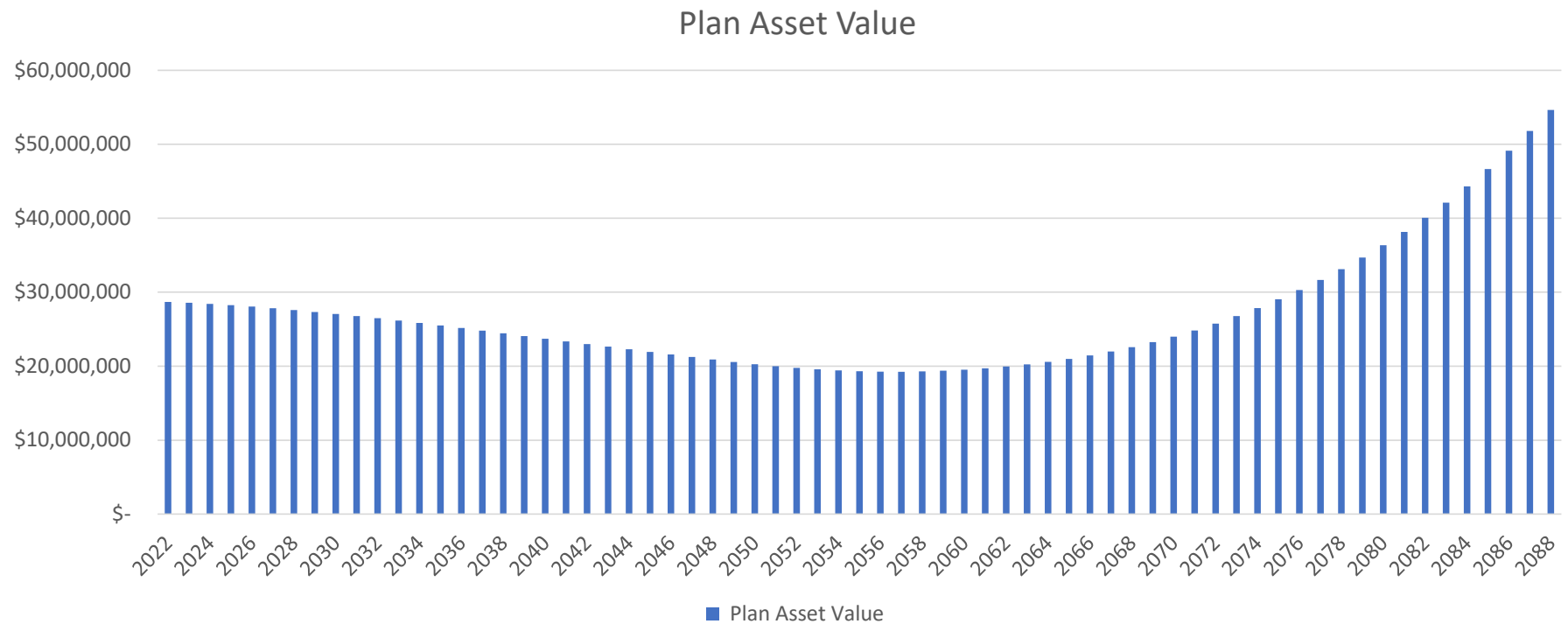

Plan Assets – 5% Earnings Rate, Amortized Contributions, and Make benefit payments from 115 Trust?

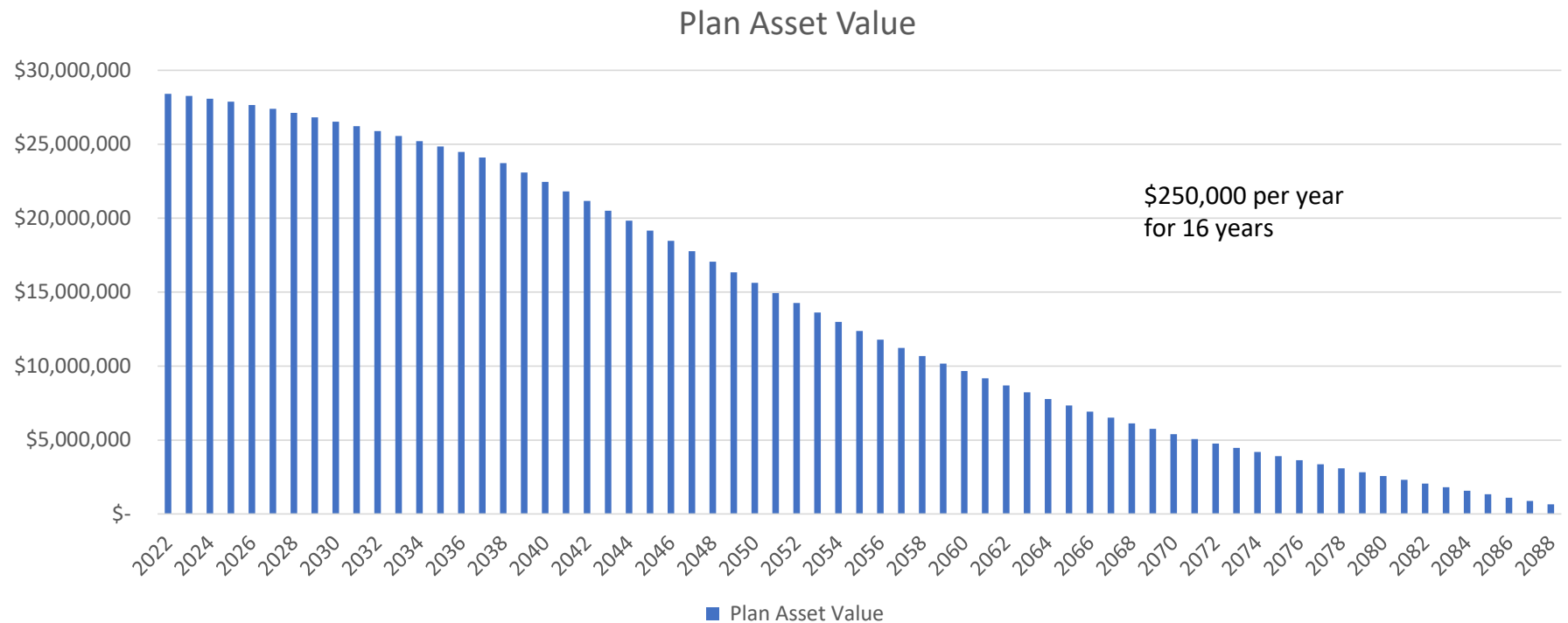

POLICY OPTIONS

- Do nothing
- Depending on Investment Earnings in 115 Trust and Assumptions remain constant:
 - \$250,000 per year for 16 years results in budget savings of \$1,500,000 if 5% year over year return on investment
 - \$500,000 per year for 7 years results in budget savings of \$1,250,000 if 5% year over year return on investment
 - \$1 million per year for 3 years results in budget savings of \$750,000 if 5% year over year return on investment
 - Pay as you go until plan asset values sufficient to cover all future costs (ie..no liability) Make incremental contributions to keep liability at \$0
- Redirect budget savings to 115 Pension Stabilization trust
- Risks
 - Lower investment earnings or losses
 - Higher medical premium costs
 - Improved mortality

NEXT STEPS

- Explore Pension Funding Policy Options
 - 115 Pension Stabilization Plan
 - Pension Obligation Bonds
 - Set aside reserves
- Draft and Recommend Combined Pension & OPEB funding policy

MacLeod Watts

December 28, 2021

Janet Dutcher
Finance Director
Mono County
25 Bryant Street Annex II
Bridgeport, CA 93517

Re: Report on the June 30, 2020 Actuarial Valuation of OPEB Liability
Development of Actuarially Determined Contributions for FYEs 2022 and 2023
GASB 75 Accounting Information for the Fiscal Year Ending June 30, 2021

Dear Ms. Dutcher:

We are pleased to enclose the results of our June 30, 2020, actuarial valuation and other relevant information regarding the other post-employment benefit (OPEB) liability of Mono County. The report describes our analysis and assumptions in detail.

The primary purposes of this report are to:

- 1) Remeasure plan liabilities as of June 30, 2020, in accordance with GASB 75's biennial valuation requirement,
- 2) Develop Actuarially Determined Contribution (ADC) levels for prefunding plan benefits,
- 3) Provide information required by GASB 75 ("Accounting and Financial Reporting for Postemployment Benefits Other Than Pension") to be reported in the County's financial statements for the fiscal year ending June 30, 2021.

This valuation was prepared with the understanding that the County will continue investing in the PARS OPEB trust using the Balanced HighMark PLUS Strategy. The assumed return on trust assets and basis for selection of the discount rates used to value the OPEB liability are discussed in the report. As with any analysis, the soundness of the report is dependent on the inputs. We encourage you to review our summary of this information to be comfortable that it matches your records.

We appreciate the opportunity to work on this analysis and acknowledge the efforts of the County employees who provided valuable time and information to enable us to prepare this report. Please let us know if we can be of further assistance.

Sincerely,



Catherine L. MacLeod, FSA, FCA, EA, MAAA
Principal & Consulting Actuary

Enclosure



Mono County

Actuarial Valuation of Other
Post-Employment Benefit Programs
As of June 30, 2020

& GASB 75 Report for the Fiscal Year Ending
June 30, 2021

Revised December 2021

MacLeod Watts

Table of Contents

A.	Executive Summary	1
	OPEB Obligations of the County	1
	OPEB Funding Policy.....	2
	Actuarial Assumptions.....	2
	Important Dates for GASB 75 in this Report	2
	Significant Results and Differences from the Prior Valuation	3
	Impact on Statement of Net Position and OPEB Expense for Fiscal 2021	3
	Important Notices	3
B.	Valuation Process	4
C.	Valuation Results as of June 30, 2020	6
D.	Accounting Information (GASB 75)	9
	Components of Net Position and Expense.....	9
	Change in Net Position During the Fiscal Year	10
	Change in Fiduciary Net Position During the Measurement Period	11
	Expected Long-term Return on Trust Assets.....	11
	Recognition Period for Deferred Resources.....	12
	Deferred Resources as of Fiscal Year End and Expected Future Recognition	12
	Sensitivity of Liabilities to Changes in the Discount Rate and Healthcare Cost Trend Rate	13
	Schedule of Changes in the County’s Net OPEB Liability and Related Ratios	14
	Schedule of Contributions.....	15
	Detail of Changes to Net Position	16
	Schedule of Deferred Outflows and Inflows of Resources.....	17
	County Contributions to the Plan.....	18
	Projected Benefit Payments (15-year projection).....	19
	Sample Journal Entries	20
E.	Funding Information.....	21
G.	Supporting Information.....	25
	Section 1 - Summary of Employee Data.....	25
	Section 2A - Summary of Retiree Benefit Provisions	27
	Section 2B - Excise Taxes for High Cost Retiree Coverage (Repealed).....	31
	Section 3 - Actuarial Methods and Assumptions	32
	Addendum 1: Important Background Information.....	42
	Addendum 2: MacLeod Watts Age Rating Methodology	47
	Addendum 3: MacLeod Watts Mortality Projection Methodology.....	48
	Glossary.....	49



A. Executive Summary

This report presents the results of the June 30, 2020, actuarial valuation of the other post-employment benefit program of Mono County. The purposes of this valuation are to: 1) summarize the results of the valuation; 2) develop Actuarially Determined Contribution (ADC) levels for prefunding plan benefits; and 3) assess the OPEB liabilities and provide disclosure information as required by Statement No. 75 of the Governmental Accounting Standards Board (GASB 75) for the fiscal year ending June 30, 2021.

Important background information regarding the valuation process can be found in Addendum 1. We recommend users of the report read this information to familiarize themselves with the process and context of actuarial valuations, including the requirements of GASB 75. The pages following this executive summary present various exhibits and other relevant information appropriate for financial reporting and plan funding.

Absent material changes to this program, the results of this 2020, valuation will also be applied to prepare the County's GASB 75 report for the fiscal year ending June 30, 2022. If there are any significant changes in the census, plan benefits or eligibility, an earlier valuation might be required or appropriate.

OPEB Obligations of the County

The County offers continuation of medical, dental, vision and life insurance coverage to its qualifying retiring employees. This coverage may create one or more of the following types of OPEB liabilities:

- **Explicit subsidy liabilities:** An "explicit subsidy" exists when the employer contributes directly toward the cost of retiree healthcare.¹ In this program, the County pays a portion of medical, dental, vision and life insurance premiums for qualifying retirees. Amounts paid vary by bargaining group, employment date and retirement date. See Supporting Information Section 2 for details.
- **Implicit subsidy liabilities:** An "implicit subsidy" exists when the premiums charged for retiree coverage are lower than the expected retiree claims for that coverage. In the CalPERS medical program, the same monthly premiums are charged for active employees and for pre-Medicare retirees. CalPERS has confirmed that the claims experience of these members is considered together in setting premium rates. Separate premium rates are charged for retirees and dependents covered by Medicare, based on the claims experience of these members only.

As is the nature of group premium rate structures, at some ages, retirees are expected to experience higher claims than the premiums they pay, where at other ages, the reverse is true. We determine the implicit rate subsidy for retiree medical² and life insurance coverage as the projected difference between (a) estimated retiree claim costs by age and (b) premiums charged for retiree coverage. For more information on this process see Section 3 and Addendum 2: MacLeod Watts Age Rating Methodology.

We assumed no implicit liability exists with respect to retiree dental and vision coverage.

¹ A liability for potential future excise tax liability for "high cost" retiree coverage was included in the prior valuation. However, this provision of the Affordable Care Act was repealed in December 2019, so this liability has been eliminated.

² Premium rates for Medicare retirees are developed separately with no cross-subsidy from active employee premiums. A practice note relating to Actuarial Standard of Practice #6 clarifies that age-specific health care costs should be developed for all ages in determining employer liabilities under a retiree health benefit program for those retirees for whom the employer is expected to pay any portion of the implicit subsidy. The implicit subsidy for retirees covered by Medicare Supplement plans is expected to be paid by other employers or retirees in the pool rather than by the County.



Executive Summary (Continued)

OPEB Funding Policy

The County's OPEB funding policy affects the calculation of liabilities by impacting the discount rate that is used to develop the plan liability and expense. "Prefunding" is the term used when an agency consistently contributes an amount based on an actuarially determined contribution (ADC) each year. GASB 75 allows prefunded plans to use a discount rate that reflects the expected earnings on trust assets. Pay-as-you-go, or "PAYGO", is the term used when an agency only contributes the required retiree benefits when due. When an agency finances retiree benefits on a pay-as-you-go basis, GASB 75 requires the use of a discount rate equal to a 20-year high grade municipal bond rate.

The County has been and continues to prefund its OPEB liability, contributing 100% or more of the Actuarially Determined Contributions each year. With the County's approval, the discount rate used in this valuation is 5.8%, reflecting the County's expectation of the long term return on trust assets as of the measurement date. For additional information, see Expected Return on Trust Assets on page 11.

Actuarial Assumptions

The actuarial "demographic" assumptions (i.e., rates of retirement, death, disability or other termination of employment) used in this report were chosen, for the most part, to be the same as the actuarial demographic assumptions used for the most recent valuation of the retirement plan(s) covering County employees. Other assumptions, such as age-related healthcare claims, healthcare trend, retiree participation rates and spouse coverage, were selected based on demonstrated plan experience and/or our best estimate of expected future experience. All these assumptions, and more, impact expected future benefits. Please note that this valuation has been prepared on a closed group basis. This means that only employees and retirees present as of the valuation date are considered. We do not consider replacement employees for those we project to leave the current population of plan participants until the valuation date following their employment.

We emphasize that this actuarial valuation provides a projection of future results based on many assumptions. Actual results are likely to vary to some extent and we will continue to monitor these assumptions in future valuations. See Section 3 for a description of assumptions used in this valuation.

Important Dates for GASB 75 in this Report

GASB 75 allows reporting liabilities as of any fiscal year end based on: (1) a *valuation date* no more than 30 months plus 1 day prior to the close of the fiscal year end; and (2) a *measurement date* up to one year prior to the close of the fiscal year. The following dates were used for this report:

Fiscal Year End	June 30, 2021
Measurement Date	June 30, 2020
Measurement Period	June 30, 2019 to June 30, 2020
Valuation Date	June 30, 2020



Executive Summary
(Concluded)

Significant Results and Differences from the Prior Valuation

No benefit changes were reported to MacLeod Watts relative to those in place at the time the June 2018 valuation was prepared. We reviewed and updated some assumptions used to project the OPEB liability. Differences between actual and expected results based on updated census and premium data were also reflected (referred to as “plan experience”). Overall, the Total OPEB Liability on the current measurement date is higher than that reported one year ago.

Section C. presents the valuation results and provides details of the impact of the new assumptions and plan experience. Assumption changes are described at the end of Section 3. See *Recognition Period for Deferred Resources* on page 12 for details on accounting recognition of these changes.

Impact on Statement of Net Position and OPEB Expense for Fiscal 2021

The plan’s impact to Net Position will be the sum of difference between assets and liabilities as of the measurement date plus the unrecognized net outflows and inflows of resources. Different recognition periods apply to deferred resources depending on their origin. The plan’s impact on Net Position on the measurement date can be summarized as follows:

Items	For Reporting At Fiscal Year Ending June 30, 2021
Total OPEB Liability	\$ 30,912,347
Fiduciary Net Position	22,670,568
Net OPEB Liability (Asset)	8,241,779
Deferred (Outflows) of Resources	(4,621,739)
Deferred Inflows of Resources	5,063,240
Impact on Statement of Net Position	<u>\$ 8,683,280</u>
OPEB Expense, FYE 6/30/2021	<u>\$ 150,963</u>

Important Notices

This report is intended to be used only to present the actuarial information relating to other postemployment benefits for the County’s financial statements. The results of this report may not be appropriate for other purposes, where other assumptions, methodology and/or actuarial standards of practice may be required or more suitable. We note that various issues in this report may involve legal analysis of applicable law or regulations. The County should consult counsel on these matters; MacLeod Watts does not practice law and does not intend anything in this report to constitute legal advice. In addition, we recommend the County consult with their internal accounting staff or external auditor or accounting firm about the accounting treatment of OPEB liabilities.



B. Valuation Process

This valuation is based on employee census data and benefits initially submitted to us by the County and clarified in various related communications. A summary of the employee data is provided in Section 1 and a summary of the benefits provided under the Plan is provided in Section 2. While individual employee records have been reviewed to verify that they are reasonable in various respects, the data has not been audited and we have otherwise relied on the County as to its accuracy. The valuation has been performed in accordance with the process described below using the actuarial methods and assumptions described in Section 3 and is consistent with our understanding of Actuarial Standards of Practice.

Projecting Plan Benefits and Liabilities

In projecting benefit values and liabilities, we first determine an expected premium or benefit stream over each current retiree's or active employee's future retirement. Benefits may include both direct employer payments (explicit subsidies) and any implicit subsidies arising when retiree premiums are expected to be partially subsidized by premiums paid for active employees. The projected benefit streams reflect assumed trends in the cost of those benefits and assumptions as to the expected dates when benefits will end. Assumptions regarding the probability that each employee will remain in service to receive benefits and the likelihood the employee will elect coverage for themselves and their dependents are also applied.

We then calculate a present value of these future benefit streams by discounting the value of each future expected employer payment back to the valuation date using the valuation discount rate. This present value is called the **Present Value of Projected Benefits (PVPB)** and represents the current value of all expected future plan payments to current retirees and current active employees. Note that this long-term projection does not anticipate entry of future employees.

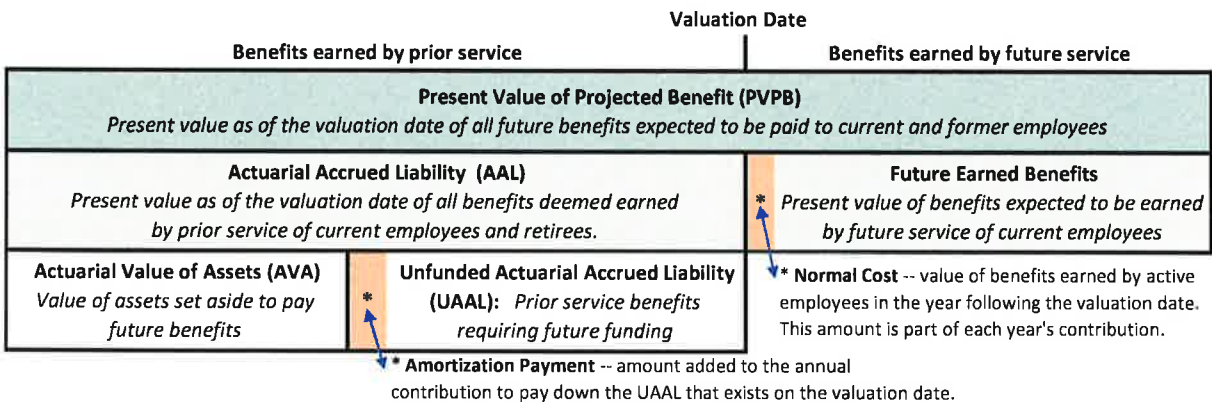

The next step in the valuation process splits the Present Value of Projected Benefits into 1) the value of benefits already earned by prior service of current employees and retirees and 2) the value of benefits expected to be earned by future service of current employees. Actuaries employ an "attribution method" to divide the PVPB into prior service liabilities and future service liabilities. For this valuation we used the **Entry Age Normal** attribution method. This method is the most common used for government funding purposes and the only attribution method allowed for financial reporting under GASB 75.



Valuation Process (Concluded)

We call the value of benefits deemed earned by prior service the **Actuarial Accrued Liability (AAL)**. Benefits deemed earned by service of active employees in a single year is called the **Normal Cost** of benefits. The present value of all future normal costs (PVFNC) plus the Actuarial Accrued Liability will equal the Present Value of Projected Benefits (i.e., $PVPB = AAL + PVFNC$).

Certain actuarial terms and GASB 75 terms may be used interchangeably. Some are compared below.

Actuarial Funding Terminology

Present Value of Projected Benefits (PVPB)
Actuarially Accrued Liability (AAL)
Market Value of Assets
Unfunded Actuarially Accrued Liability (UAAL)
Normal Cost

GASB 75 Terminology

N/A; typically not reported for accounting purposes
Total OPEB Liability (TOL)
Fiduciary Net Position
Net OPEB Liability
Service Cost

Incorporating Plan Assets

Funds set aside for future benefits may be considered contributions to an OPEB plan only if the account established for holding the accumulated assets are separate from and independent of the control of the employer and legally protected from its creditors. Furthermore, the sole purpose of the account should be to provide benefits and/or pay expenses of the plan. These conditions generally require the establishment of a legal trust, such as the County's trust account with PARS.

Trust assets and earnings accumulate so that the trust can make benefit payments to retirees or reimburse the County for making those payments directly. The difference between the value of trust assets (i.e. the Market Value of Assets), or a smoothed asset value (i.e. the Actuarial Value of Assets), and the Actuarial Accrued Liability is referred to as the **Unfunded Actuarial Accrued Liability (UAAL)**. The UAAL represents the past service portion of the present value of benefits which remains unfunded as of the valuation date. A plan is generally considered "fully funded" when the UAAL is zero, i.e., when the accumulated prior service costs and plan assets are in equilibrium.

Future County contributions will fund the value of benefits earned by future service of current active employees. Each year's portion of this future benefit cost is called the "normal cost". In addition, future contributions will also fund the remaining unfunded portion of OPEB benefits earned by past service (the UAAL), if any. Various strategies might be employed to pay down the UAAL such as longer or shorter amortization payments, and flat or escalating payments depending on the plan sponsors goals and funding philosophy. Section E provides additional discussion.

Variation in Future Results

Please note that projections of future benefits over such long periods (frequently 60 or more years) which are dependent on numerous assumptions regarding future economic and demographic variables are subject to revision as future events unfold. While we believe that the assumptions and methods used in this valuation are reasonable for the purposes of this report, the costs to the County reflected in this report may change in the future, perhaps materially. Demonstrating the range of potential future plan costs was beyond the scope of our assignment.



C. Valuation Results as of June 30, 2020

This section presents the basic results of our recalculation of the OPEB liability using the updated employee data, plan provisions and asset information provided to us for the June 2020 valuation. We described the general process for projecting all future benefits to be paid to retirees and current employees in the preceding Section. Expected annual benefits have been projected using the actuarial methods and assumptions outlined in Supporting Information, Section 3.

Healthcare benefits are paid for qualifying County retirees. Please see Supporting Information, Section 2 for details.

The following graph illustrates the annual other post-employment benefits projected to be paid on behalf of current retirees and current employees expected to retire from the County.

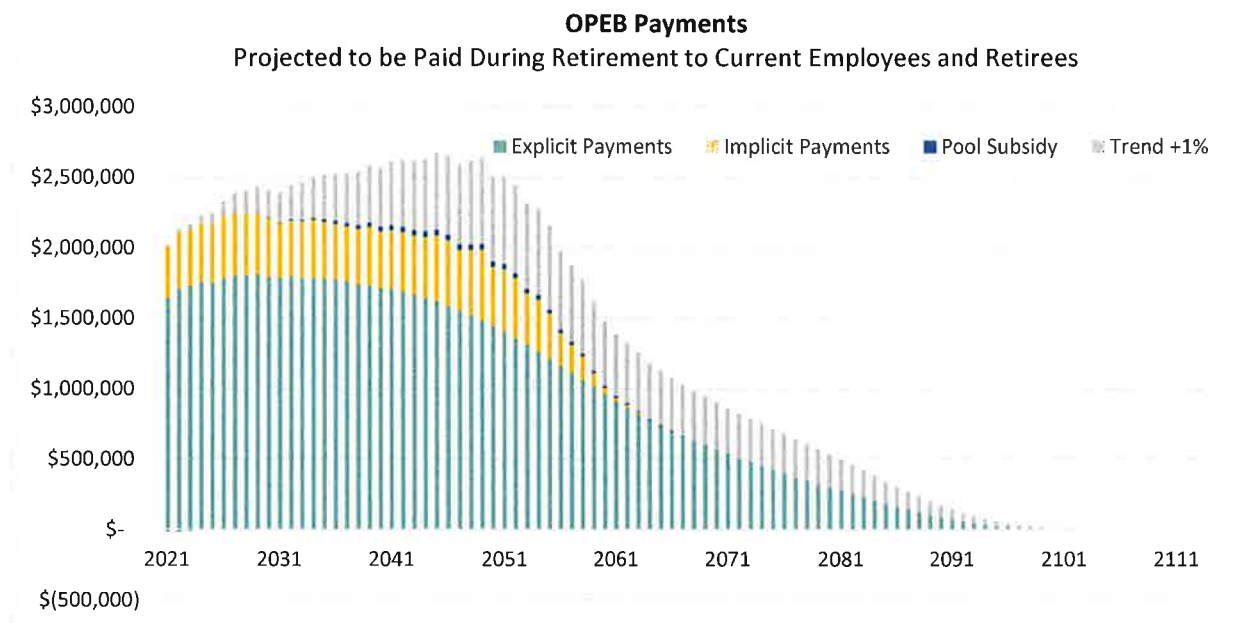

The amounts shown in green reflect the expected payment by the County toward retiree medical, dental, vision and life insurance premiums while those in yellow reflect the implicit subsidy benefits (i.e., the excess of retiree medical and prescription drug claims over the premiums expected to be charged during the year for retirees' coverage). The projections (in gray) reflect increases in benefit levels if healthcare trend were 1% higher.

The first 15 years of benefit payments from the graph above are shown in tabular form on page 19.

Liabilities relating to these projected benefits are shown beginning on the following page.



Valuation Results as of June 30, 2020
(Continued)

This chart compares the results measured as of June 30, 2019, based on the June 2018 valuation, with the results measured as of June 30, 2020, based on the June 2020 actuarial valuation using the 5.8% discount rate applied for financial reporting purposes.

Valuation Date	6/30/2018		6/30/2020	
Fiscal Year Ending	6/30/2019		6/30/2021	
Measurement Date	6/30/2019		6/30/2020	
Discount rate	6.00%		5.80%	
Number of Covered Employees				
Actives	275		293	
Retirees	191		189	
Total Participants	466		482	
OPEB Subsidy Type	Explicit	Implicit	Explicit	Implicit
	Total	Total	Total	Total
Actuarial Present Value of Projected Benefits				
Actives	\$ 7,749,801	\$ 3,254,823	\$ 8,180,866	\$ 3,427,071
Retirees	20,857,462	2,317,786	19,437,229	3,128,131
Total APVPB	28,607,263	5,572,609	27,618,095	6,555,202
Total OPEB Liability (TOL)				
Actives	5,806,985	2,072,350	6,271,253	2,075,734
Retirees	20,857,462	2,317,786	19,437,229	3,128,131
TOL	26,664,447	4,390,136	25,708,482	5,203,865
Fiduciary Net Position		22,015,762		22,670,568
Net OPEB Liability		9,038,821		8,241,779
Service Cost		142,014	247,989	145,325
For the period following the measurement date	263,329	405,343		393,314

The ratio of the Fiduciary Net Position (plan assets) to the Total OPEB Liability measured for accounting purposes is 73.3% on June 30, 2020. This is slightly up from 70.9% as of June 30, 2019. Trust assets increased by \$654,806 from investment earnings, while the Total OPEB Liability decreased by \$142,236 during the same period. Expected and unexpected changes in the TOL are discussed on the next page.



Valuation Results as of June 30, 2020
(Concluded)

Expected changes: The TOL was expected to increase by \$222,270 from normal plan operation, i.e., additional service and interest costs accruing for the period, less benefits paid to retirees.

Unexpected changes decreased the TOL by \$364,506 and may fall into one of the following categories:

- *Plan experience* includes differences between what was assumed and what actually occurred since the prior valuation. Plan experience decreased the TOL by \$1,628,132. The majority of this decrease relates to lower than expected premiums for the plans covering County employees.
- *Changes in actuarial assumptions or methodology:* The assumption changes listed below collectively increased the TOL by \$1,263,626. For more on the assumption changes, see the last page of Section 3, Supporting Information.
- *Benefit changes:* There were no changes reported since the prior valuation was completed.

This chart reconciles the TOL reported on June 30, 2020, to the TOL to be reported as of June 30, 2021.

Reported Total OPEB Liability at June 30, 2020 Measurement Date June 30, 2019	\$ 31,054,583
Expected Changes:	
Service Cost	405,343
Benefit Payments	(2,010,358)
Interest Cost	1,827,285
Total Expected Change	222,270
Expected Total OPEB Liability at June 30, 2021 Measurement Date June 30, 2020	\$ 31,276,853
Unexpected Changes:	
Plan experience different than assumed:	
Premiums, caps, estimated claims and coverage levels other than expected	\$ (3,491,674)
Retirements and turnover other than expected	935,062
Other plan experience	928,480
Assumption Changes:	
Changed discount rate	683,369
Added implicit for Medicare retirees	608,550
Change in healthcare trend model	471,563
Elimination of excise tax liability	(353,929)
Decrease in assumed future retiree participation rate	(149,991)
Decrease in spouse coverage assumption	108,352
Change in demographic and economic assumptions and mortality improvement scale	(104,288)
Total Unexpected Change	(364,506)
Actual Total OPEB Liability at June 30, 2021 Measurement Date June 30, 2020	\$ 30,912,347



D. Accounting Information (GASB 75)

The following exhibits are designed to satisfy the reporting and disclosure requirements of GASB 75 for the fiscal year end June 30, 2021. The County is classified for GASB 75 purposes as a single employer.

Components of Net Position and Expense

The exhibit below shows the development of Net Position and Expense as of the Measurement Date.

Plan Summary Information for FYE June 30, 2021 <i>Measurement Date is June 30, 2020</i>	Mono County
Items Impacting Net Position:	
Total OPEB Liability	\$ 30,912,347
Fiduciary Net Position	22,670,568
Net OPEB Liability (Asset)	8,241,779
<i>Deferred (Outflows) Inflows of Resources Due to:</i>	
Assumption Changes	(2,338,117)
Plan Experience	5,063,240
Investment Experience	(271,703)
Deferred Contributions	(2,011,919)
Net Deferred (Outflows) Inflows of Resources	441,501
Impact on Statement of Net Position, FYE 6/30/2021	\$ 8,683,280
Items Impacting OPEB Expense:	
Service Cost	\$ 405,343
Cost of Plan Changes	-
Interest Cost	1,827,285
Expected Earnings on Assets	(1,320,946)
<i>Recognized Deferred Resource items:</i>	
Assumption Changes	501,727
Plan Experience	(1,174,977)
Investment Experience	(87,469)
OPEB Expense, FYE 6/30/2021	\$ 150,963



Accounting Information

(Continued)

Change in Net Position During the Fiscal Year

The exhibit below shows the year-to-year changes in the components of Net Position.

For Reporting at Fiscal Year End <i>Measurement Date</i>	6/30/2020 <i>6/30/2019</i>	6/30/2021 <i>6/30/2020</i>	Change During Period
Total OPEB Liability	\$ 31,054,583	\$ 30,912,347	\$ (142,236)
Fiduciary Net Position	22,015,762	22,670,568	654,806
Net OPEB Liability (Asset)	9,038,821	8,241,779	(797,042)
<i>Deferred Resource (Outflows) Inflows Due to:</i>			
Assumption Changes	(1,576,218)	(2,338,117)	(761,899)
Plan Experience	4,610,085	5,063,240	453,155
Investment Experience	481,906	(271,703)	(753,609)
Deferred Contributions	(2,010,358)	(2,011,919)	(1,561)
Net Deferred (Outflows) Inflows	1,505,415	441,501	(1,063,914)
Impact on Statement of Net Position	<u>\$ 10,544,236</u>	<u>\$ 8,683,280</u>	<u>\$ (1,860,956)</u>

Change in Net Position During the Fiscal Year

Impact on Statement of Net Position, FYE 6/30/2020	\$ 10,544,236
OPEB Expense (Income)	150,963
Employer Contributions During Fiscal Year	<u>(2,011,919)</u>
Impact on Statement of Net Position, FYE 6/30/2021	<u>\$ 8,683,280</u>

OPEB Expense

Employer Contributions During Fiscal Year	\$ 2,011,919
Deterioration (Improvement) in Net Position	<u>(1,860,956)</u>
OPEB Expense (Income), FYE 6/30/2021	<u>\$ 150,963</u>



Accounting Information
(Continued)

Change in Fiduciary Net Position During the Measurement Period

	Mono County
Fiduciary Net Position at Fiscal Year Ending 6/30/2020	\$ 22,015,762
<i>Measurement Date 6/30/2019</i>	
Changes During the Period:	
Investment Income	654,806
Employer Contributions	2,010,358
Benefit Payments	(2,010,358)
Net Changes During the Period	654,806
 Fiduciary Net Position at Fiscal Year Ending 6/30/2021	 \$ 22,670,568
<i>Measurement Date 6/30/2020</i>	

Expected Long-term Return on Trust Assets

In March 2021, PARS published an expected return of 6.22% for the Balanced Portfolio, prior to offset for non-imbedded investment related fees. This expected return was determined using a building-block method and best-estimate ranges of expected future real rates of return for each major asset class (expected returns, net of OPEB plan investment expense and inflation). These ranges are combined to produce the long-term expected rate of return by weighting the expected future real rates of return by the target asset allocation percentage and by adding expected inflation. The target allocation and best estimates of geometric real rates of return for each major class are summarized in this table.

Portfolio (Investment Strategy)	Balanced	
Asset Class	Expected Return	Weight
Equity		60.00%
Large Cap Core	6.80%	32.00%
Mid Cap Core	7.10%	6.00%
Small Cap Core	7.90%	9.00%
Real Estate	6.60%	2.00%
International	7.30%	7.00%
Emerging Markets	7.30%	4.00%
Fixed Income		35.00%
Short Term Bond	3.30%	6.75%
Intermediate Term Bond	3.90%	27.00%
High Yield	6.10%	1.25%
Alternatives		
Cash	2.40%	5.00%
Expected Return		6.22%
Expected Standard Deviation		9.92%

Non-imbedded fees were estimated to reduce the expected yield above by 42 basis points (0.42%), reducing the net expected return on trust assets to 5.80% per year.

The County approved 5.80% as the assumed long-term return on trust assets.



Accounting Information
(Continued)

Recognition Period for Deferred Resources

Liability changes due to plan experience which differs from what was assumed in the prior measurement period and/or from assumption changes during the period are recognized over the plan's Expected Average Remaining Service Life ("EARSL"). The EARSL of 7.07 years is the period used to recognize such changes in the OPEB Liability arising during the current measurement period.

Changes in the Fiduciary Net Position due to investment performance different from the assumed earnings rate are always recognized over 5 years.

Liability differences due to benefit changes occurring during the period are recognized immediately.

Deferred Resources as of Fiscal Year End and Expected Future Recognition

The exhibit below shows deferred resources as of the fiscal year end June 30, 2021.

Mono County	Deferred Outflows of Resources	Deferred Inflows of Resources
Changes of Assumptions	\$ 2,338,117	\$ -
Differences Between Expected and Actual Experience	-	5,063,240
Net Difference Between Projected and Actual Earnings on Investments	271,703	-
Deferred Contributions	2,011,919	-
Total	\$ 4,621,739	\$ 5,063,240

The County will recognize the Deferred Contributions in the next fiscal year. In addition, future recognition of these deferred resources is shown below.

For the Fiscal Year Ending June 30	Recognized Net Deferred Outflows (Inflows) of Resources
2022	\$ (760,718)
2023	(578,913)
2024	(541,644)
2025	(465,419)
2026	(51,556)
Thereafter	(55,170)



Accounting Information

(Continued)

Sensitivity of Liabilities to Changes in the Discount Rate and Healthcare Cost Trend Rate

The discount rate used for the fiscal year end 2021 is 5.80%. Healthcare Cost Trend Rate was assumed to start at 5.7% in January 2022 and grade down to 4% for years 2076 and later. Dental premiums, vision premiums and the PEMHCA minimum employer contribution (MEC) were assumed to increase by 4% per year. The impact of a 1% increase or decrease in these assumptions is shown in the chart below.

Sensitivity to:			
Change in Discount Rate	Current - 1% 4.80%	Current 5.80%	Current + 1% 6.80%
Total OPEB Liability	34,573,084	30,912,347	27,868,566
Increase (Decrease)	3,660,737		(3,043,781)
% Increase (Decrease)	11.8%		-9.8%
Net OPEB Liability (Asset)	11,902,516	8,241,779	5,197,998
Increase (Decrease)	3,660,737		(3,043,781)
% Increase (Decrease)	44.4%		-36.9%
Change in Healthcare Cost Trend Rate	Current Trend - 1%	Current Trend	Current Trend + 1%
Total OPEB Liability	27,809,370	30,912,347	34,630,151
Increase (Decrease)	(3,102,977)		3,717,804
% Increase (Decrease)	-10.0%		12.0%
Net OPEB Liability (Asset)	5,138,802	8,241,779	11,959,583
Increase (Decrease)	(3,102,977)		3,717,804
% Increase (Decrease)	-37.6%		45.1%



Accounting Information
(Continued)

Schedule of Changes in the County's Net OPEB Liability and Related Ratios

GASB 75 requires presentation of the 10-year history of changes in the Net OPEB Liability. Only results for years since GASB 75 was implemented (fiscal years 2018 through 2021) are shown below.

Fiscal Year End	6/30/2021	6/30/2020	6/30/2019	6/30/2018
<i>Measurement Date</i>	<i>6/30/2020</i>	<i>6/30/2019</i>	<i>6/30/2018</i>	<i>6/30/2017</i>
<i>Valuation Date</i>	<i>6/30/2020</i>	<i>6/30/2018</i>	<i>6/30/2018</i>	<i>1/1/2016</i>
<i>Discount Rate</i>	<i>5.80%</i>	<i>6.00%</i>	<i>6.00%</i>	<i>6.25%</i>
Total OPEB liability				
Service Cost	\$ 405,343	\$ 392,584	\$ 349,637	\$ 338,631
Interest	1,827,285	1,814,641	2,117,566	2,085,442
Changes of benefit terms	-	-	(14,836)	-
Differences between expected and actual experience	(1,628,132)	-	(6,499,465)	-
Changes of assumptions	1,263,626	-	2,222,210	-
Benefit payments	(2,010,358)	(2,008,149)	(1,702,041)	(2,108,215)
Net change in total OPEB liability	(142,236)	199,076	(3,526,929)	315,858
Total OPEB liability - beginning	31,054,583	30,855,507	34,382,436	34,066,578
Total OPEB liability - ending (a)	\$ 30,912,347	\$ 31,054,583	\$ 30,855,507	\$ 34,382,436
Plan fiduciary net position				
Contributions - employer	\$ 2,010,358	\$ 3,008,149	\$ 2,702,041	\$ 3,108,215
Net investment income	654,806	1,225,517	1,310,117	1,853,936
Benefit payments	(2,010,358)	(2,008,149)	(1,702,041)	(2,108,215)
Net change in plan fiduciary net position	654,806	2,225,517	2,310,117	2,853,936
Plan fiduciary net position - beginning	22,015,762	19,790,245	17,480,128	14,626,192
Plan fiduciary net position - ending (b)	\$ 22,670,568	\$ 22,015,762	\$ 19,790,245	\$ 17,480,128
Net OPEB liability - ending (a) - (b)	\$ 8,241,779	\$ 9,038,821	\$ 11,065,262	\$ 16,902,308
Covered-employee payroll	\$ 20,164,975	\$ 19,814,600	\$ 19,639,908	\$ 18,365,669
Net OPEB liability as a % of covered-employee payroll	40.87%	45.62%	56.34%	92.03%



Accounting Information
(Continued)

Schedule of Contributions

This chart shows the County's contributions since GASB 75 was implemented.

Fiscal Year End	6/30/2021	6/30/2020	6/30/2019	6/30/2018
Actuarially Determined Contribution	\$ 1,177,006	\$ 1,241,911	\$ 1,380,860	\$ 2,064,918
Contributions in relation to the actuarially determined contribution	2,011,919	2,010,358	3,008,149	2,702,041
Contribution deficiency (excess)	\$ (834,913)	\$ (768,447)	\$ (1,627,289)	\$ (637,123)
Covered employee payroll	\$ 22,870,559	\$ 20,164,975	\$ 19,814,600	\$ 19,639,908
Contributions as % of covered employee payroll	8.80%	9.97%	15.18%	13.76%
% of ADC contributed	170.94%	161.88%	217.85%	130.85%

Notes to Schedule

Valuation Date used for ADCs:

Actuarial cost method

Amortization method

Amortization period

Asset valuation method

Inflation

Healthcare cost trend rates

Salary increases

Investment rate of return

Retirement age

Mortality

Mortality Improvement

6/30/2018			1/1/2016
Entry Age Normal			Entry Age Normal
Level dollar basis closed 30 years			Level dollar basis closed 30 years
18 ys remain	19 ys remain	20 yrs remain	21 years remain
Market Value			Market Value
2.75%			2.50%
7% in 2020 to 5% in 2024 in steps of 0.5%			Getzen model. Pre-Medicare: 5.25% in 2020 fluctuating to 4.5% in 2070. Medicare: 5.75% in 2020 grading to ultimate rate of 4.5% in 2085
3.25%			Misc: 10.9% initial grading to 3.3% for 30+ YOS Police: 14.7% initial grading to 4.3% for 8+ YOS Fire: 19.8% initial grading to 3.6% for 30+ YOS
6.00%			6.25%
50 to 75			50 to 75
CalPERS 2017 Experience Study			CalPERS 2014 Experience Study
MW Scale 2018 generationally			Scale BB to 2028



Accounting Information
(Continued)

Detail of Changes to Net Position

The chart below details changes to all components of Net Position.

Mono County	Total OPEB Liability (a)	Fiduciary Net Position (b)	Net OPEB Liability (c) = (a) - (b)	(d) Deferred Outflows (Inflows) Due to:				Impact on Statement of Net Position (e) = (c) - (d)
				Assumption Changes	Plan Experience	Investment Experience	Deferred Contributions	
Balance at Fiscal Year Ending 6/30/2020 <i>Measurement Date 6/30/2019</i>	\$ 31,054,583	\$ 22,015,762	\$ 9,038,821	\$ 1,576,218	\$ (4,610,085)	\$ (481,906)	\$ 2,010,358	\$ 10,544,236
Changes During the Period:								
Service Cost	405,343		405,343					405,343
Interest Cost	1,827,285		1,827,285					1,827,285
Expected Investment Income		1,320,946	(1,320,946)					(1,320,946)
Employer Contributions		2,010,358	(2,010,358)					(2,010,358)
Changes of Benefit Terms			-					-
Benefit Payments	(2,010,358)	(2,010,358)	-					-
Assumption Changes	1,263,626		1,263,626	1,263,626				-
Plan Experience	(1,628,132)		(1,628,132)		(1,628,132)			-
Investment Experience		(666,140)	666,140			666,140		-
Recognized Deferred Resources				(501,727)	1,174,977	87,469	(2,010,358)	1,249,639
Employer Contributions in Fiscal Year							2,011,919	(2,011,919)
Net Changes in Fiscal Year 2020-2021	(142,236)	654,806	(797,042)	761,899	(453,155)	753,609	1,561	(1,860,956)
Balance at Fiscal Year Ending 6/30/2021 <i>Measurement Date 6/30/2020</i>	\$ 30,912,347	\$ 22,670,568	\$ 8,241,779	\$ 2,338,117	\$ (5,063,240)	\$ 271,703	\$ 2,011,919	\$ 8,683,280



Accounting Information
(Continued)

Schedule of Deferred Outflows and Inflows of Resources

A listing of all deferred resource bases used to develop the Net Position and OPEB Expense is shown below. Deferred Contributions are not shown.

Measurement Date: June 30, 2020

Date Created	Deferred Resource			Recognition of Deferred Outflow or Deferred (Inflow) in Measurement Period:								
	Created Due To	Initial Amount	Period (Yrs)	Annual Recognition	Balance as of Jun 30, 2020	2019-20 (FYE 2021)	2020-21 (FYE 2022)	2021-22 (FYE 2023)	2022-23 (FYE 2024)	2023-24 (FYE 2025)	2024-25 (FYE 2026)	Thereafter
6/30/2017	Investment Earnings	Greater than Expected	5.00	\$ (181,805)	\$ (181,804)	\$ (181,805)	\$ (181,804)	\$ -	\$ -	\$ -	\$ -	\$ -
6/30/2018	Plan Experience	Decreased Liability	6.88	(944,690)	(3,665,395)	(944,690)	(944,690)	(944,690)	(944,690)	(831,325)	-	-
6/30/2018	Assumption Changes	Increased Liability	6.88	2,222,210	1,253,222	322,996	322,996	322,996	322,996	284,234	-	-
6/30/2018	Investment Earnings	Greater than Expected	5.00	(37,272)	(74,543)	(37,272)	(37,272)	(37,271)	-	-	-	-
6/30/2019	Investment Earnings	Greater than Expected	5.00	(1,620)	(4,862)	(1,620)	(1,620)	(1,622)	-	-	-	-
6/30/2020	Plan Experience	Decreased Liability	7.07	(230,287)	(1,397,845)	(230,287)	(230,287)	(230,287)	(230,287)	(230,287)	(230,287)	(246,410)
6/30/2020	Assumption Changes	Increased Liability	7.07	1,263,626	1,084,895	178,731	178,731	178,731	178,731	178,731	178,731	191,240
6/30/2020	Investment Earnings	Less than Expected	5.00	133,228	532,912	133,228	133,228	133,228	133,228	133,228	-	-



Accounting Information
 (Continued)

County Contributions to the Plan

The County contributions to the Plan occur as benefits are paid to retirees and/or to the OPEB trust. Benefit payments may occur in the form of direct payments for premiums (“explicit subsidies”) and/or indirect payments to retirees in the form of higher premiums for active employees (“implicit subsidies”). Note: The implicit subsidy contribution does not represent cash payments to retirees, but reclassification of a portion of active healthcare cost to be treated as a retiree health cost.

No benefits were paid from (reimbursed to the County) from the PARS OPEB trust and no new contributions were paid into the trust during the measurement period. OPEB contributions paid by the County during the measurement period are shown below.

Employer Contributions During the Measurement Period, Jul 1, 2019 thru Jun 30, 2020	Mono County
Employer Contributions to the Trust	\$ -
Employer Contributions in the Form of Direct Benefit Payments (not reimbursed by trust)	1,656,302
Implicit contributions	354,056
Total Employer Contributions During the Measurement Period	\$ 2,010,358

Benefits payments and other County contributions made in the year following the measurement period but prior to the end of the fiscal year are shown below.

Employer Contributions During the Fiscal Year, Jul 1, 2020 thru Jun 30, 2021	Mono County
Employer Contributions to the Trust	\$ -
Employer Contributions in the Form of Direct Benefit Payments (not reimbursed by trust)	1,643,753
Implicit contributions	368,166
Total Employer Contributions During the Fiscal Year	\$ 2,011,919



Accounting Information
(Continued)

Projected Benefit Payments (15-year projection)

The following is an estimate of other post-employment benefits to be paid on behalf of current retirees and current employees expected to retire from the County. These expected benefits have been projected on the basis of the actuarial assumptions outlined in Section 3. The projections do not include any benefits expected to be paid on behalf of current active employees *prior to* retirement, nor do they include any benefits for potential *future employees* (i.e., those who might be hired in future years).

Projected Annual Benefit Payments								
Fiscal Year Ending June 30	Explicit Subsidy			Implicit Subsidy			Subsidy (to) from Pool	Grand Total
	Current Retirees	Future Retirees	Total	Current Retirees	Future Retirees	Total		
2021	\$1,643,753	\$ -	\$1,643,753	\$ 368,166	\$ -	\$ 368,166	\$ -	\$2,011,919
2022	1,484,961	227,589	1,712,550	325,056	76,221	401,277	(11,620)	2,102,207
2023	1,486,747	241,264	1,728,011	308,258	91,342	399,600	(9,396)	2,118,215
2024	1,483,570	280,224	1,763,794	283,872	119,118	402,990	(5,886)	2,160,898
2025	1,443,934	316,056	1,759,990	258,919	145,683	404,602	(6,145)	2,158,447
2026	1,438,992	342,949	1,781,941	271,234	168,427	439,661	(4,186)	2,217,416
2027	1,433,514	366,961	1,800,475	274,383	184,524	458,907	(1,722)	2,257,660
2028	1,400,512	405,684	1,806,196	239,887	204,835	444,722	(1,246)	2,249,672
2029	1,384,887	433,649	1,818,536	214,051	221,867	435,918	2,525	2,256,979
2030	1,342,283	451,871	1,794,154	165,273	251,681	416,954	3,625	2,214,733
2031	1,325,410	464,185	1,789,595	155,526	228,743	384,269	4,820	2,178,684
2032	1,314,715	484,345	1,799,060	150,414	244,253	394,667	8,532	2,202,259
2033	1,296,828	491,036	1,787,864	140,035	261,962	401,997	11,783	2,201,644
2034	1,287,005	500,483	1,787,488	141,067	269,885	410,952	14,866	2,213,306
2035	1,273,539	509,342	1,782,881	141,091	261,517	402,608	18,771	2,204,260

The amounts shown in the Explicit Subsidy table reflect the expected payment by the County toward retiree medical, dental, vision and life insurance premiums in each of the years shown. The amounts are shown separately, and in total, for those retired on the valuation date (“current retirees”) and those expected to retire after the valuation date (“future retirees”).

The amounts shown in the Implicit Subsidy section reflect the expected excess of retiree medical and prescription drug claims over the premiums expected to be charged during the year for retirees’ coverage, again shown separately and in total for those currently retired and for those expected to retire in the future. The County is expected to provide these implicit subsidy benefits to retirees in the form of higher active employee premiums than would be charged if no retirees were pooled with them.

The amounts shown as Pool Subsidies are the excess of expected claims over premiums charged for the County’s retirees covered or projected to be covered by Supplemental Medicare plans (but excludes those covered by Medicare Advantage plans). These premiums rates are determined without regard to active employee claims or premiums. The pool subsidy represents a cross-subsidy between other employers or their retirees within the Medicare-retiree pool. As such, while it is included in the liability and projected benefits for retirees, it is not included as a benefit expected to be provided by the County.



Accounting Information
(Concluded)

Sample Journal Entries

Beginning Account Balances

As of the fiscal year beginning 7/1/2020	Debit	Credit
Net OPEB Liability		9,038,821
Deferred Resource -- Assumption Changes	1,576,218	
Deferred Resource -- Plan experience		4,610,085
Deferred Resource -- Investment Experience		481,906
Deferred Resource -- Contributions	2,010,358	
Net Position	10,544,236	

** The entries above assume nothing is on the books at the beginning of the year. So to the extent that values already exist in, for example, the Net OPEB Liability account, then only the difference should be adjusted. The entries above represent the values assumed to exist at the start of the fiscal year.*

Journal entry to recharacterize retiree benefit payments as OPEB

Expense.	Debit	Credit
OPEB Expense	1,643,753	
Premium Expense		1,643,753

** This entry assumes a prior journal entry was made to record the payment for retiree premiums. This entry assumes the prior entry debited an account called "Premium Expense" and credited Cash. This entry reverses the prior debit to "Premium Expense" and recharacterizes that entry as an "OPEB Expense".*

Journal entries to record implicit subsidies during the fiscal year

	Debit	Credit
OPEB Expense	368,166	
Premium Expense		368,166

** This entry assumes that premiums for active employees were recorded to an account called "Premium Expense". This entry reverses the portion of premium payments that represent implicit subsidies and assigns that value to OPEB Expense.*

Journal entries to record account activity during the fiscal year

	Debit	Credit
Net OPEB Liability	797,042	
Deferred Resource -- Assumption Changes	761,899	
Deferred Resource -- Plan experience		453,155
Deferred Resource -- Investment Experience	753,609	
Deferred Resource -- Contributions	1,561	
OPEB Expense		1,860,956



E. Funding Information

The employer's OPEB funding policy and level of contributions to an irrevocable OPEB trust directly affects the discount rate which is used to calculate the OPEB liability to be reported in the employer's financial statements. Prefunding (setting aside funds to accumulate in an irrevocable OPEB trust) has certain advantages, one of which is the ability to (potentially) use a higher discount rate in the determination of liabilities for GASB 75 reporting purposes. Prefunding also improves the security of benefits for current and potential future recipients and contributes to intergenerational taxpayer equity by better matching the cost of the benefits to the service years in which they are "earned" and which correspond to years in which taxpayers benefit from those services.

Paying Down the UAAL

Once an employer decides to prefund, a decision must be made about how to pay for benefits related to accumulated prior service that have not yet been funded (the UAAL³). This is most often, though not always, handled through structured amortization payments. The period and method chosen for amortizing this unfunded liability can significantly affect the Actuarially Determined Contribution (ADC) or other basis selected for funding the OPEB program.

Much like paying off a mortgage, when the AAL exceeds plan assets, choosing a longer amortization period to pay off the UAAL means smaller payments, but the payments will be required for more years; plan investments will have less time to work toward helping reduce required contribution levels. When the plan is in a surplus position, the reverse is true, and a longer amortization period may be preferable.

There are several ways the amortization payment can be determined. The most common methods are calculating the amortization payment as a level dollar amount or as a level percentage of payroll. The employer might also choose to apply a shorter period when the UAAL only when it is positive, i.e., when trust assets are lower than the AAL, but opt for a longer period or to exclude amortization of a negative UAAL, when assets exceed the AAL. The entire UAAL may be amortized as one single component or may be broken into multiple components reflecting the timing and source of each change, such as those arising from assumption changes, benefit changes and/or liability or investment experience.

The amortization period(s) should not exceed the number of years which would allow current trust assets plus future contributions and earnings to be sufficient to pay all future benefits and trust expenses each year. Prefunding of OPEB is optional and contributions at any level are permitted. However, if trust sufficiency is not expected, a discount rate other than the assumed trust return will likely be required for accounting purposes.

Funding and Prefunding of the Implicit Subsidy

An implicit subsidy liability is created when retiree medical claims are expected to exceed the premiums charged for retiree coverage. Recognition of the estimated implicit subsidy each year is handled by an accounting entry, reducing the amount paid for active employees and shifting that amount to be treated as a retiree healthcare expense/contribution (see Sample Journal Entries). The implicit subsidy is a true benefit to the retiree but can be difficult to see when medical premiums are set as a flat rate for both actives and pre-Medicare retirees.

³ We use actuarial, rather than accounting, terminology to describe the components used to develop the ADCs.



OPEB Funding Information

(Continued)

This might lead some employers to believe the benefit is not real or is merely an accounting construct, and thus to forgo prefunding of retiree implicit benefits.

Consider what would happen if the retiree premiums were based only on expected retiree claims experience. Almost certainly, retiree premiums would increase while premiums for active employees would go down if the active premiums no longer had to help support the higher retiree claims. *Who would pay the increases in retiree premiums?* Current plan documents and bargaining agreements would have to be consulted. Depending on circumstances, the increase in retiree premiums might remain the responsibility of the employer, pass entirely to the retirees, or some blending of the two. The answer would determine whether separate retiree-only premium rates would result in a higher or lower employer OPEB liability. In the current premium structure, with blended active and pre-Medicare retiree premiums, the employer is clearly, though indirectly, paying the implicit retiree cost.

The prefunding decision is complex. OPEB materiality, budgetary concerns, desire to use the full trust rate in developing the liability for GASB 75, and other factors must be weighed by each employer. Since prefunding OPEB benefits is not required, each employer's OPEB prefunding strategy will depend on how they balance these competing perspectives.

Development of the Actuarially Determined Contributions

The County has approved development of ADCs based on the following two components, which are then adjusted with interest to each fiscal year end:

- The amounts attributed to service performed in the current fiscal year (the normal cost) and
- Amortization of the unfunded actuarial accrued liability over a closed 30-year period on a level dollar basis; 17 years remain for the fiscal year ending June 30, 2022.

Actuarially Determined Contributions, developed as described above for the County's fiscal years ending June 30, 2022, and 2023 are shown the exhibit on the next page. These ADCs incorporate both explicit (cash benefit) and implicit subsidy benefit liabilities. Contributions credited toward meeting the ADC will be comprised of:

- 1) direct payments to insurers toward retiree premiums, to the extent not reimbursed to the County by the trust; plus
- 2) each year's implicit subsidy payment; and
- 3) contributions to the OPEB trust.

ADCs determined on this basis should provide for trust sufficiency, based on the current plan provisions and census data, provided all assumptions are exactly realized and if the County contributes 100% or more of the ADC each year. When an agency commits to funding the trust at or above the ADC, the expected long-term trust return may be used as the discount rate in determining the plan liability for accounting purposes. Trust sufficiency cannot be guaranteed to a certainty, however, because of the non-trivial risk that the assumptions used to project future benefit liabilities may not be realized.



OPEB Funding Information

(Continued)

The exhibit below shows the development of the ADC levels for the County's fiscal years ending June 30, 2022 and June 30, 2023. We have also included the ADC developed for fiscal year end 2021, as developed from the June 2018 valuation.

Valuation date	6/30/2018	6/30/2020	
	6/30/2021	6/30/2022	6/30/2023
For fiscal year ending			
Expected long-term return on assets	6.00%	5.80%	
Discount rate	6.00%	5.80%	
Number of Covered Employees			
Actives	275	293	
Retirees	191	189	
Total Participants	466	482	
Actuarial Present Value of Projected Benefits	34,151,993	34,133,790	33,950,379
Actuarial Accrued Liability (AAL)			
Actives	8,586,521	9,116,424	9,762,307
Retirees	22,682,330	21,983,406	21,406,753
Total AAL	31,268,851	31,099,830	31,169,060
Actuarial Value of Assets	23,328,120	23,985,461	25,376,618
Unfunded AAL (UAAL)	7,940,731	7,114,369	5,792,442
UAAL Amortization method	Level Dollar	Level Dollar	Level Dollar
Remaining amortization period (years)	18	17	16
Amortization Factor	11.4773	11.2462	10.8404
Actuarially Determined Contribution (ADC)			
Normal Cost	\$ 418,516	\$ 405,114	\$ 417,268
Amortization of UAAL	691,867	632,604	534,337
Interest to fiscal year end	66,623	60,187	55,193
Total ADC	1,177,006	1,097,905	1,006,798

The ADCs for the 3 years shown above are less than the total projected retiree benefits. The County has indicated it will not seek refunds from the trust for FYEs 2021 and 2022, but it may seek a refund during FYE 2023. As such, the chart below shows our current best estimate of the County's estimated OPEB contributions for these years:

Funding of the ADC

1 Implicit subsidy contribution	\$ 368,166	\$ 401,277	\$ 399,600
Additional payments needed to meet ADC	808,840	696,628	607,198
2 Projected agency paid premiums for retirees	1,643,753	1,712,550	1,728,011
3 Expected agency contribution to OPEB trust	-	-	(1,120,813)
Total Expected Employer Contributions (1+2+3)	\$ 2,011,919	\$ 2,113,827	\$ 1,006,798
Shortfall (excess) in ADC funding	(834,913)	(1,015,922)	-



F. Certification

The primary purposes of this report are: (1) to provide actuarial information of the other postemployment benefits (OPEB) provided by Mono County in compliance with Statement 75 of the Governmental Accounting Standards Board (GASB 75); and (2) to provide Actuarially Determined Contributions for prefunding of this program in conformity with the County's OPEB funding policy. The County is not required to contribute the ADC shown in this report and we make no representation that it will, in fact, fund the OPEB trust at any particular level.

In preparing this report we relied without audit on information provided by the County. This information includes, but is not limited to, plan provisions, census data, and financial information. We performed a limited review of this data and found the information to be reasonably consistent. The accuracy of this report is dependent on this information and if any of the information we relied on is incomplete or inaccurate, then the results reported herein will be different from any report relying on more accurate information.

We consider the actuarial assumptions and methods used in this report to be individually reasonable under the requirements imposed by GASB 75 and taking into consideration reasonable expectations of plan experience. The results provide an estimate of the plan's financial condition at one point in time. Future actuarial results may be significantly different due to a variety of reasons including, but not limited to, demographic and economic assumptions differing from future plan experience, changes in plan provisions, changes in applicable law, or changes in the value of plan benefits relative to other alternatives available to plan members.

Alternative assumptions may also be reasonable; however, demonstrating the range of potential plan results based on alternative assumptions was beyond the scope of our assignment except to the limited extent required by GASB 75 and in accordance with the County's stated OPEB funding policy. Results for accounting purposes may be materially different than results obtained for other purposes such as plan termination, liability settlement, or underlying economic value of the promises made by the plan.

This report is prepared solely for the use and benefit of the County and may not be provided to third parties without prior written consent of MacLeod Watts. Exceptions are: the County may provide copies of this report to their professional accounting and legal advisors who are subject to a duty of confidentiality, and the County may provide this work to any party if required by law or court order. No part of this report should be used as the basis for any representations or warranties in any contract or agreement without the written consent of MacLeod Watts.

The undersigned actuaries are unaware of any relationship that might impair the objectivity of this work. Nothing within this report is intended to be a substitute for qualified legal or accounting counsel. Both actuaries are members of the American Academy of Actuaries and meet the qualification standards for rendering this opinion.

Signed: December 28, 2021



Catherine L. MacLeod, FSA, FCA, EA, MAAA



J. Kevin Watts, FSA, FCA, MAAA



G. Supporting Information

Section 1 - Summary of Employee Data

Active employees: The County reported 293 active members in the data provided to us for the June 2020 valuation. Of these, 249 active employees are currently participating in the medical program and 44 employees are waiving coverage.

Distribution of Benefits-Eligible Active Employees								
Current Age	Years of Service						Total	Percent
	Under 1	1 to 4	5 to 9	10 to 14	15 to 19	20 & Up		
Under 25	2	1					3	1%
25 to 29	13	13	4	1			31	11%
30 to 34	6	23	15	3			47	16%
35 to 39	8	16	10	9	6		49	17%
40 to 44	6	11	6	10	6	1	40	14%
45 to 49		7	6	8	5	5	31	11%
50 to 54	2	7	5	6	5	9	34	12%
55 to 59	1	8	2	11	5	8	35	12%
60 to 64	3	2	3	4	4	2	18	6%
65 to 69		1		1	1	2	5	2%
70 & Up							0	0%
Total	41	89	51	53	32	27	293	100%
Percent	14%	30%	17%	18%	11%	9%	100%	

Valuation	June 2018	June 2020
Average Attained Age for Actives	44.4	43.4
Average Years of Service	9.2	8.4

Retirees: There are also 189 inactive members (169 retirees and 20 survivors) currently receiving benefits under this program. Of these:

- 176 are covered by a CalPERS medical plan and 13 have other medical coverage.
- 42 receive only the PEMHCA minimum benefit; the remaining 147 receive higher benefits which vary based on their bargaining group, date employed by the County and retirement date.

This chart summarizes the ages of current retirees and beneficiaries included in this valuation.

Retirees by Age				
Current Age	PEMHCA Minimum Benefit	Enhanced Benefit	Total	Percent
Below 50	0	0	0	0%
50 to 54	0	2	2	1%
55 to 59	5	7	12	6%
60 to 64	10	17	27	14%
65 to 69	10	25	35	19%
70 to 74	9	38	47	25%
75 to 79	5	20	25	13%
80 & up	3	38	41	22%
Total	42	147	189	100%
Average Age:				
On 6/30/2020	68.9	73.9	72.8	
At retirement	59.9	56.2	57.1	



Supporting Information
(Continued)

Section 1 - Summary of Employee Data

The chart below reconciles the number of actives and retirees included in the June 2018 valuation of the County plan with those included in the June 2020 valuation.

Reconciliation of County Plan Members Between Valuation Dates						
Status	Covered Actives	Waiving Actives	Covered Service Retirees	Covered Disabled Retirees	Covered Surviving Spouses	Total
Number reported as of June 30, 2018	237	38	155	19	17	466
New employees	65	15	-	-	-	80
Separated employees	(28)	(6)	-	-	-	(34)
New retiree, elected coverage	(14)	-	14	-	-	0
New retiree, waiving coverage	(10)	(3)	-	-	-	(13)
New retiree, ineligible for coverage	(1)	-	-	-	-	(1)
Previously covered, now waiving	-	-	(1)	-	-	(1)
Previously waiving, now covered	-	-	-	-	1	1
Deceased (or presumed deceased)	-	-	(13)	(3)	2	(14)
Data corrections	-	-	(2)	-	-	(2)
Number reported as of June 30, 2020	249	44	153	16	20	482

Overall, the total number of plan members has increased by 3%, from 466 to 484. The number of active employees increased by 18 (about a 6.6% increase), while the number of retired plan members decreased by 2 (about a 1% decrease).

There were 28 new retirements between valuations. Of these:

- 14 elected to continue County coverage in retirement. Of these, 8 are eligible for enhanced benefits and the others are eligible for the PEMHCA minimum benefit (MEC) only.
- 13 waived County coverage in retirement. Of these 12 were eligible only for the MEC. 1 was higher for enhanced benefits, but is currently covered as eh spouse of an active County employee
- 1 did not qualify for any County or PEMHCA benefits.

Only 23 of the 293 current active employees are potentially eligible for higher retiree medical, dental, vision and/or life insurance benefits if they retire from the County. All other future retirees would qualify only for the PEMHCA MEC benefit. A description of these benefits begins on the following page.

GASB 75 requires the employer to report specific plan member counts. The chart at right shows these counts as of the June 30, 2020, valuation date:

Summary of Plan Member Counts	
Number of active plan members	293
Number of inactive plan members currently receiving benefits	189
Number of inactive plan members entitled to but not receiving benefits	91



Supporting Information

(Continued)

Section 2A - Summary of Retiree Benefit Provisions

OPEB provided: The County provides lifetime medical coverage for all eligible retirees. In addition, some retirees may qualify for dental, vision and life insurance benefits.

Access to medical coverage in retirement: Medical coverage is currently provided through CalPERS as permitted under the Public Employees’ Medical and Hospital Care Act (PEMHCA). This coverage requires the employee to satisfy the requirements for retirement under CalPERS: either (a) attainment of age 50 (age 52, if a miscellaneous employee new to PERS on or after January 1, 2013) with 5 years of State or public agency service or (b) an approved disability retirement.

The employee must begin his or her retirement (pension) benefit within 120 days of terminating employment with the County to be eligible to continue medical coverage through the County and be entitled to the PEMHCA Benefit described below. If an eligible employee is not already enrolled in the medical plan, he or she may enroll within 60 days of retirement or during any future open enrollment period. Coverage may be continued at the retiree’s option for his or her lifetime. A surviving spouse and other eligible dependents may also continue PEMHCA medical coverage.

PEMHCA Benefits provided: As a PEMHCA employer, the County is obligated to contribute toward the cost of retiree medical coverage for the retiree’s lifetime or until coverage is discontinued. the County’s most recent health contract resolution with CalPERS defines employer contribution toward the cost of medical plan premiums for employees and retirees to be the PEMHCA minimum employer contribution (MEC)⁴. The MEC is \$139 per month in 2020 and increased to \$143 per month for 2021.

Cafeteria Plan Contributions for Retirees: The PEMHCA required medical benefits described above are a minimum benefit provided to all employees who retire from the County and qualify for continuation of CalPERS medical coverage. However, many retirees will qualify for additional Cafeteria Plan contributions if hired by the County prior to 2001 (exact dates vary by bargaining unit). The specific amounts and options for payment may vary based on the employees hire date, retirement date and years of service with the County and under PERS. The eligibility requirements and amounts for the Cafeteria Plan contributions benefits are described on the following 3 pages.

Other County Benefits Provided: For those retirees who qualify for Cafeteria Plan contributions, the County also pays 100% of the dental, vision and life insurance premiums for the retiree and one dependent. Current premium rates for the County’s dental and vision plans are shown below, along with the face values for the County’s life insurance plan:

FYE 2020 & 2021	EE	EE + 1	EE + F
Dental	\$ 38.00	\$ 66.00	\$ 105.00
Vision	12.73	19.48	33.57

Life Insurance Face Amount		
Age	Retirees	Spouse
Below 65	\$ 5,000	\$ 1,000
65 – 69	2,500	
70 & Above	1,250	

Retirees who do not qualify for Cafeteria Plan contributions may retain coverage in the County’s dental, vision and life insurance coverages, but they must do so at their own expense.

⁴ It is our understanding that there is a pre-tax flexible benefit plan in place for active employees, providing health benefits in excess of the MEC and that PEMHCA does not require these additional payments be provided to retirees.



Supporting Information
(Continued)

Section 2A - Summary of Retiree Benefit Provisions

Eligibility for Cafeteria Plan Benefits for Future Retirees: Eligibility for Cafeteria Plan contributions in retirement varies by bargaining unit and hire date, as shown in the chart below.

Bargaining Unit	Hire Date	Eligibility Requirements for Cafeteria Plan Contributions	
		Age at Retirement	Continuous Yrs of Svc with County
Paramedic Association	Before January 1, 1986	50	5
	Between January 1, 1986, and June 30, 1987	50	10
	Between July 1, 1987, and March 14, 1996	50	15
	Between March 15, 1996, and February 3, 2003	50	20
	On or after February 4, 2003	n/a - eligible for MEC only	
Deputy Probation Officers	Before January 1, 1986	50	5
	Between January 1, 1986, and June 30, 1987	50	10
	Between July 1, 1987, and December 31, 1995	50	15
	Between January 1, 1996, and December 31, 2001	55	20
	On or after January 1, 2002	n/a - eligible for MEC only	
Sheriff's Office Management	Before January 1, 1986	50	5
	Between January 1, 1986, and June 30, 1987	50	10
	Between July 1, 1987, and December 31, 1995	50	15
	Between January 1, 1996, and July 31, 2001	55	20
	On or after August 1, 2001	n/a - eligible for MEC only	
Deputy Sheriff Association & Public Safety Officers	Before January 1, 1986	50	5
	Between January 1, 1986, and June 30, 1987	50	10
	Between July 1, 1987, and December 31, 1995	50	15
	Between January 1, 1996, and April 30, 2001	50	20
	On or after May 1, 2001	n/a - eligible for MEC only	
Management Employees and Elected Officials & Public Employees	Before January 1, 1986	50	5
	Between January 1, 1986, and June 30, 1987	50	10
	Between July 1, 1987, and December 31, 1995	50	15
	Between January 1, 1996, and December 31, 2001	55	20
	On or after January 1, 2002	n/a - eligible for MEC only	

The County previously offered an option for employees to elect contributions to a 401(a) account while actively employed in lieu of the Cafeteria Plan Benefits in retirement. Any employees who elected the 401(a) contributions, regardless of hire date, are eligible only for the MEC.

As of the June 30, 2020, valuation date, a closed group of 23 active employees across 5 bargaining units remained eligible for Cafeteria Plan contributions in retirement.

The grids on the following two pages summarize the Cafeteria Plan contributions amounts for retirees who qualify for this benefit.



Supporting Information
(Continued)

Section 2A - Summary of Retiree Benefit Provisions

The grids below and on the following page describe the benefits provided to those retirees who qualify for Cafeteria Plan contributions in retirement. Eligibility requirements are described on the previous page.

Bargaining Unit	Date of Retirement	Minimum Retiree Share of Premium			Maximum District Cafeteria Plan Contribution (but not more than actual premium for retiree and enrolled dependents)
		Single	Two-Party	Family	
Paramedic Association	Before January 1, 2013	\$0	\$0	\$0	100% of PERS Choice premium for chosen coverage level, minus the MEC and minus the retiree share of premium
	Between January 1, 2013, and October 6, 2014	\$0	\$25	\$50	
	Between October 7, 2014, and December 31, 2018	\$25	\$50	\$100	
	On or after January 1, 2019	No minimum retiree share. Retiree portion varies based on retiree's selected coverage.			<p>Pre-Medicare Cap: <i>Through 12/31/19:</i> 80% of the PERS Choice premium for the retiree's chosen coverage level, minus the MEC <i>Effective 1/1/20:</i> 95% of the PERS Select premium for the retiree's chosen coverage level, minus the MEC; or, if not enrolled in PERS Select, 80% of the PERS Choice premium for the retiree's coverage level, minus the MEC.</p> <p>Medicare Cap: 100% of the PERS Choice Medicare Supplement plan for retiree's coverage level, minus the MEC</p>
Deputy Probation Officers	Before July 1, 2011	\$0	\$0	\$0	100% of PERS Choice premium for chosen coverage level, minus the MEC and minus the retiree share of premium
	Between July 1, 2011, and December 31, 2012	\$0	\$25	\$50	
	On or after January 1, 2013	\$25	\$50	\$100	
Sheriff's Office Management	Before July 1, 2015	\$0	\$0	\$0	100% of PERS Choice premium for chosen coverage level, minus the MEC and minus the retiree share of premium
	On or after July 1, 2015	\$25	\$50	\$100	



Supporting Information (Continued)

Section 2A - Summary of Retiree Benefit Provisions

Bargaining Unit	Date of Retirement	Minimum Retiree Share of Premium			Maximum District Cafeteria Plan Contribution (but not more than actual premium for retiree and enrolled dependents)
		Single	Two-Party	Family	
Deputy Sheriff Association	Before January 3, 2012	\$0	\$0	\$0	100% of PERS Choice premium for chosen coverage level, minus the MEC and minus the retiree share of premium
	Between January 3, 2012, and December 31, 2013	\$0	\$25	\$50	
	Between January 1, 2014, and December 31, 2017	\$25	\$50	\$100	
	On or after January 1, 2018	No minimum retiree share. Retiree portion varies based on retiree's selected coverage.			<p>Pre-Medicare Cap: 95% of the PORAC premium for the retiree's chosen coverage level, minus the MEC; or, if not enrolled in PORAC, 80% of the PERS Choice premium for the retiree's coverage level, minus the MEC.</p> <p>Medicare Cap: 100% of the PERS Choice Medicare Supplement plan for retiree's coverage level, minus the MEC.</p>
Public Safety Officers	Before October 1, 2012	\$0	\$0	\$0	100% of PERS Choice premium for chosen coverage, minus the MEC and minus the retiree share of premium
	Between October 1, 2012, and December 31, 2013	\$0	\$25	\$50	
	Between January 1, 2014, and December 31, 2018	\$25	\$50	\$100	
	On or after January 1, 2019	No minimum retiree share. Retiree portion varies based on retiree's selected coverage.			<p>Pre-Medicare Cap: 95% of the PORAC premium for the retiree's chosen coverage level, minus the MEC; or, if not enrolled in PORAC, 80% of the PERS Choice premium for the retiree's coverage level, minus the MEC.</p> <p>Medicare Cap: 100% of the PERS Choice Medicare Supplement plan for retiree's coverage level, minus the MEC.</p>
Management Employees and Elected Officials & Public Employees	Before September 1, 2011	\$0	\$0	\$0	100% of PERS Choice premium for chosen coverage level, minus the MEC and minus the retiree share of premium
	Between September 1, 2011, and October 6, 2014	\$0	\$25	\$50	
	On or after October 7, 2014	\$25	\$50	\$100	



Supporting Information
(Continued)

Section 2A - Summary of Retiree Benefit Provisions

Current premium rates: The 2021 CalPERS monthly medical plan rates in the Region 1 rate group are shown in the table below. If different rates apply where the member resides outside of this area, those rates are reflected in the valuation, but not listed here. The CalPERS administration fee is assumed to be expensed each year and has not been projected as an OPEB liability in this valuation:

Region 1 2021 Health Plan Rates						
Plan	Actives and Pre-Med Retirees			Medicare Eligible Retirees		
	Ee Only	Ee & 1	Ee & 2+	Ee Only	Ee & 1	Ee & 2+*
Kaiser HMO	\$ 813.64	\$ 1,627.28	\$ 2,115.46	\$ 324.48	\$ 648.96	\$ 1,137.14
PERS Choice PPO	935.84	1,871.68	2,433.18	349.97	699.94	1,261.44
PERS Select PPO	566.67	1,133.34	1,473.34	349.97	699.94	1,039.94
PERSCare PPO	1,294.69	2,589.38	3,366.19	381.25	762.50	1,539.31
PORAC Region 1	799.00	1,725.00	2,199.00	513.00	1,022.00	1,496.00

* Rates shown in this column reflect 2 parties on Medicare and 1 party pre-Medicare

Section 2B - Excise Taxes for High Cost Retiree Coverage (Repealed)

The Patient Protection and Affordable Care Act (ACA) included a 40% excise tax on high-cost employer-sponsored health coverage. The tax applied to the aggregate annual cost of an employee's applicable coverage that exceeds a dollar limit. Implementation of this tax had been delayed by subsequent legislation to 2022.

As noted earlier in this report, this excise tax on high cost retiree coverage was repealed by Senate Amendment to H.R. 1865, *Further Consolidated Appropriations Act, 2020*, and signed by the President on December 20, 2019. We have now removed this excise tax liability from the results of this valuation.



Supporting Information

(Continued)

Section 3 - Actuarial Methods and Assumptions

The ultimate real cost of an employee benefit plan is the value of all benefits and other expenses of the plan over its lifetime. These payments depend only on the terms of the plan and the administrative arrangements adopted. Actuarial assumptions are used to estimate the cost of these benefits; the funding method spreads the expected costs on a level basis over the life of the plan.

Important Dates

Valuation Date	June 30, 2020
Fiscal Year End	June 30, 2021
Measurement Date	Last day of the prior fiscal year (June 30, 2020)

Valuation Methods

Funding Method	Entry Age Normal Cost, level percent of pay
Asset Valuation Method	Market Value of Assets
Participants Valued	Only current active employees and retired participants and covered dependents are valued. No future entrants are considered in this valuation.

Development of Age-related Medical Premiums

Actual premium rates for retirees and their spouses were adjusted to an age-related basis by applying medical claim cost factors developed from the data presented in the report, "Health Care Costs – From Birth to Death", sponsored by the Society of Actuaries. A description of the use of claims cost curves can be found in MacLeod Watts's Age Rating Methodology provided in Addendum 2 to this report.

Monthly baseline premium costs were set equal to the active single premiums shown in the rate chart in Section 2. Representative claims costs derived from the dataset provided by CalPERS are shown on the following page.

Medicare-eligible retirees are covered by plans which are rated solely on the experience of Medicare retirees with no subsidy by active employee premiums. The benefit for retirees or survivors who qualify only for the PEMHCA MEC is less than the lowest age adjusted premium; as such, any implicit subsidy between retirees at this lower benefit level is paid by other retirees and is not reflected as an OPEB liability of the County. We developed age-related claim costs only for those Medicare retirees covered by Medicare Supplement plans (not Medicare Advantage) who are currently or are projected to receive benefits in excess of the PEMHCA MEC.



Supporting Information
(Continued)

Section 3 - Actuarial Methods and Assumptions (Valuation methods – continued)

Illustrative monthly claims by age, medical plan, and gender:

	Age	Kaiser Region 1		PERS Choice Region 1		PERS Select Region 1		PERSCare Region 1		PORAC Region 1		PERS Choice Region 2		PERS Select Region 2		PERSCare Region 2	
		Male	Female	Male	Female	Male	Female	Male	Female	Male	Female	Male	Female	Male	Female	Male	Female
Pre-Medicare	50	\$ 829	\$1,027	\$ 831	\$1,030	\$ 631	\$ 782	\$1,009	\$1,250	\$ 757	\$ 938	\$ 679	\$ 841	\$ 540	\$ 669	\$ 876	\$1,085
	53	978	1,128	980	1,131	744	858	1,189	1,373	893	1,031	801	924	637	735	1,032	1,192
	56	1,135	1,214	1,138	1,217	864	924	1,381	1,477	1,037	1,109	930	994	739	791	1,199	1,282
	59	1,301	1,312	1,304	1,315	990	998	1,583	1,596	1,189	1,198	1,066	1,074	847	854	1,374	1,386
	62	1,479	1,446	1,483	1,449	1,125	1,100	1,800	1,760	1,351	1,321	1,212	1,185	963	942	1,562	1,527
Medicare	65	<i>Age based claims not developed for Medicare Advantage plans</i>		299	286	300	287	322	309	436	418	299	286	300	287	322	309
	70			335	324	336	325	361	349	489	473	335	324	336	325	361	349
	75			364	350	365	352	392	378	531	512	364	350	365	352	392	378
	80			381	366	383	368	411	395	557	535	381	366	383	368	411	395
	90			359	362	360	363	387	390	524	528	359	362	360	363	387	390
	95			356	356	358	357	384	384	520	520	356	356	358	357	384	384

	Age	PORAC Region 2		Kaiser Region 3		PERS Choice Region 3		PERSCare Region 3		Kaiser Out of State		PERS Choice Out of State		PERSCare Out of State		PORAC Out of State	
		Male	Female	Male	Female	Male	Female	Male	Female	Male	Female	Male	Female	Male	Female	Male	Female
Pre-Medicare	50	\$ 650	\$ 805	\$ 681	\$ 844	\$ 676	\$ 837	\$ 863	\$1,069	\$ 691	\$ 857	\$ 508	\$ 630	\$ 651	\$ 807	\$ 615	\$ 763
	53	766	884	803	927	797	920	1,017	1,174	815	941	599	692	768	886	726	838
	56	890	952	932	997	926	990	1,181	1,263	947	1,012	696	744	892	954	843	901
	59	1,020	1,028	1,069	1,077	1,061	1,069	1,354	1,365	1,085	1,094	798	804	1,022	1,031	966	974
	62	1,160	1,134	1,215	1,188	1,206	1,179	1,539	1,505	1,233	1,206	907	886	1,162	1,136	1,098	1,074
Medicare	65	436	418	<i>Age based claims not developed for Medicare Advantage plans</i>		299	286	322	309	<i>Age based claims not developed for Medicare Advantage plans</i>		299	286	322	309	436	418
	70	489	473			335	324	361	349			489	473				
	75	531	512			364	350	392	378			531	512				
	80	557	535			381	366	411	395			557	535				
	90	524	528			359	362	387	390			524	528				
	95	520	520			356	356	384	384			520	520				



Supporting Information (Continued)

Economic Assumptions

Long Term Return on Assets	<i>For plan accounting and plan funding:</i> 5.8% as of June 30, 2020 and 6.0% as of June 30, 2019, net of plan investment expenses
Discount rate `	5.8% as of June 30, 2020 and 6.0% as of June 30, 2019
General Inflation Rate	2.5% per year
Salary Increase	3.0% per year; since benefits do not depend on salary, this is used to allocate the cost of benefits between service years.
Healthcare Trend	Medical plan premiums and claims costs by age are assumed to increase once each year. The increases over the prior year's levels are assumed to be effective on the dates shown below:

Effective January 1	Premium Increase	Effective January 1	Premium Increase
2021	Actual	2061-2066	4.8%
2022	5.7%	2067	4.7%
2023	5.6%	2068	4.6%
2024	5.5%	2069	4.5%
2025-2026	5.4%	2070-2071	4.4%
2027-2029	5.3%	2072	4.3%
2030-2051	5.2%	2073-2074	4.2%
2052	5.1%	2075	4.1%
2053-2055	5.0%	2076	4.0%
2056-2060	4.9%	& later	4.0%

The healthcare trend shown above was developed using the Getzen Model 2021_b published by the Society of Actuaries using the following settings: CPI 2.5%; Real GDP Growth 1.5%; Excess Medical Growth 1.1%; Expected Health Share of GDP in 2030 20.3%; Resistance Point 25%; Year after which medical growth is limited to growth in GDP 2075.

The PEMHCA minimum employer contribution and dental and vision premiums are all assumed to increase by 4.0% per year.

Participant Election Assumptions

Participation Rate	<p><i>Active employees:</i> 100% are assumed to continue their current plan election in retirement, if eligible for benefits greater than the PEMHCA minimum. If eligible only for the PEMHCA minimum benefit, we assumed 50% of currently enrolled employees and 30% of currently waiving employees would elect coverage in retirement. Those not currently enrolled are assumed to elect coverage in the PERS Choice Region 1.</p> <p><i>Retired participants:</i> Existing medical plan elections are assumed to be continued until the retiree's death.</p>
--------------------	---



Supporting Information (Continued)

Section 3 - Actuarial Methods and Assumptions (Participant Election Assumptions – continued)

Spouse Coverage

Active employees: 70% of future retirees eligible for benefits greater than the PEMHCA minimum are assumed to elect spouse coverage in retirement. If eligible only for the PEMHCA minimum benefit, we assumed 50% would elect spouse coverage. Surviving spouses are assumed to retain coverage until their death. Husbands are assumed to be 3 years older than their wives.

Retired participants: Existing elections for spouse coverage are assumed to continue until the spouse’s death. Actual spouse ages are used, where known; if not, husbands are assumed to be 3 years older than their wives. Spouse gender is assumed to be the opposite of the employee.

Dependent Coverage

Active employees and retired participants covering dependent children are assumed to end such coverage when the youngest currently covered dependent reaches age 26.

Medicare Eligibility

Absent contrary data, all individuals are assumed to be eligible for Medicare Parts A and B at age 65.

Demographic Assumptions

Demographic actuarial assumptions used in this valuation are based on the 2017 experience study of the California Public Employees Retirement System using data from 1997 to 2015, except a different basis used to project future mortality improvements. Rates for selected age and service are shown below and on the following pages. Mortality rates used were those published CalPERS rates, adjusted to back out 15 years of Scale MP 2016 to central year 2015, then projected as described below.

Mortality Improvement

MacLeod Watts Scale 2020 applied generationally from 2015 (see Addendum 3)

**Mortality After Retirement
(before improvement applied)**

Healthy Retirees			Disabled Retirees		
CalPERS Public Agency Miscellaneous, Police & Fire Post Retirement Mortality			CalPERS Public Agency Disabled Miscellaneous Post-Retirement Mortality		
Age	Male	Female	Age	Male	Female
40	0.00070	0.00040	20	0.00027	0.00008
50	0.00431	0.00390	30	0.00044	0.00018
60	0.00758	0.00524	40	0.00070	0.00040
70	0.01490	0.01044	50	0.01371	0.01221
80	0.04577	0.03459	60	0.02447	0.01545
90	0.14801	0.11315	70	0.03737	0.02462
100	0.35053	0.30412	80	0.07218	0.05338
110	1.00000	1.00000	90	0.16585	0.14826



Supporting Information

(Continued)

Section 3 - Actuarial Methods and Assumptions

Mortality After Retirement
(before improvement applied)

Healthy Lives

Disabled Miscellaneous

CalPERS Public Agency Miscellaneous, Police & Fire Post Retirement Mortality		
Age	Male	Female
40	0.00070	0.00040
50	0.00431	0.00390
60	0.00758	0.00524
70	0.01490	0.01044
80	0.04577	0.03459
90	0.14801	0.11315
100	0.35053	0.30412
110	1.00000	1.00000

CalPERS Public Agency Disabled Miscellaneous Post-Retirement Mortality		
Age	Male	Female
20	0.00027	0.00008
30	0.00044	0.00018
40	0.00070	0.00040
50	0.01371	0.01221
60	0.02447	0.01545
70	0.03737	0.02462
80	0.07218	0.05338
90	0.16585	0.14826

Disabled Fire Safety

Disabled Police Safety

CalPERS Public Agency Disabled Fire Post- Retirement Mortality		
Age	Male	Female
20	0.00027	0.00009
30	0.00031	0.00014
40	0.00034	0.00022
50	0.00780	0.00681
60	0.01250	0.00809
70	0.02361	0.01647
80	0.06612	0.04975
90	0.18524	0.14349

CalPERS Public Agency Disabled Police Post- Retirement Mortality		
Age	Male	Female
20	0.00034	0.00010
30	0.00023	0.00012
40	0.00023	0.00017
50	0.00642	0.00563
60	0.01059	0.00696
70	0.02185	0.01537
80	0.06477	0.04883
90	0.18501	0.14169

Disability Retirement Rates

CalPERS Public Agency Miscellaneous Disability From Dec 2017 Experience Study Report		
Age	Male	Female
20	0.00017	0.00010
25	0.00017	0.00010
30	0.00019	0.00024
35	0.00039	0.00071
40	0.00102	0.00135
45	0.00151	0.00188
50	0.00158	0.00199
55	0.00158	0.00149
60	0.00153	0.00105

CalPERS Public Agency Fire Combined Disability From Dec 2017 Experience Study Report	
Age	Unisex
20	0.00015
25	0.00029
30	0.00066
35	0.00129
40	0.00235
45	0.00418
50	0.02128
55	0.03134
60	0.04442

CalPERS Public Agency Police Combined Disability From Dec 2017 Experience Study Report	
Age	Unisex
20	0.00010
25	0.00175
30	0.00496
35	0.00818
40	0.01140
45	0.01461
50	0.01925
55	0.04909
60	0.06212



Supporting Information
(Concluded)

Section 3 - Actuarial Methods and Assumptions

Service Retirement Rates

Miscellaneous: The following miscellaneous retirement formulas apply:

"Classic" employees hired before 6/1/2012:	2.7% @ 55
"Classic" employees between 6/1/2012 and 12/31/2012:	2.5% @ 55
"PEPRA" employees:	2% @ 62

Probation Officers: The following peace officer retirement formulas apply:

"Classic" employees:	3% @ 50
"PEPRA" employees:	2.7% @ 57

Sheriffs & Public Safety Officers: The following sheriff retirement formulas apply:

"Classic" employees hired before 1/1/2013:	3% @ 50
"Classic" employees hired on or after 12/27/2012:	3% @ 55
"PEPRA" employees:	2.7% @ 57

EMS: The following fire retirement formulas apply:

"Classic" employees hired before 1/1/2007:	3% @ 50
"Classic" employees hired on or after 7/1/2007:	2% @ 50
"PEPRA" employees:	2.7% @ 57

Sample rates of assumed future retirements applicable to each of these retirement benefit formulas are shown in tables on the following pages.

Miscellaneous Employees: 2.7% at 55 formula						
From CalPERS Experience Study Report Issued December 2017						
Current Age	Years of Service					
	5	10	15	20	25	30
50	0.0030	0.0100	0.0160	0.0340	0.0330	0.0450
55	0.0330	0.0550	0.0780	0.1130	0.1560	0.2340
60	0.0600	0.0860	0.1120	0.1500	0.1820	0.2380
65	0.1400	0.1740	0.2080	0.2540	0.3060	0.3890
70	0.1500	0.1810	0.2120	0.2430	0.2910	0.3500
75 & over	1.0000	1.0000	1.0000	1.0000	1.0000	1.0000

Miscellaneous Employees: 2.5% at 55 formula						
From CalPERS Experience Study Report Issued December 2017						
Current Age	Years of Service					
	5	10	15	20	25	30
50	0.0080	0.0140	0.0200	0.0260	0.0330	0.0500
55	0.0200	0.0380	0.0550	0.0730	0.1220	0.1920
60	0.0440	0.0720	0.1010	0.1300	0.1580	0.1970
65	0.1200	0.1560	0.1930	0.2290	0.2650	0.3330
70	0.1200	0.1560	0.1930	0.2290	0.2650	0.3330
75 & over	1.0000	1.0000	1.0000	1.0000	1.0000	1.0000



Supporting Information

(Continued)

Section 3 - Actuarial Methods and Assumptions

Service Retirement Rates
(continued)

Miscellaneous "PEPRA" Employees: 2% at 62 formula						
From CalPERS Experience Study Report Issued December 2017						
Current	Years of Service					
Age	5	10	15	20	25	30
50	0.0000	0.0000	0.0000	0.0000	0.0000	0.0000
55	0.0100	0.0190	0.0280	0.0360	0.0610	0.0960
60	0.0310	0.0510	0.0710	0.0910	0.1110	0.1380
65	0.1080	0.1410	0.1730	0.2060	0.2390	0.3000
70	0.1200	0.1560	0.1930	0.2290	0.2650	0.3330
75 & over	1.0000	1.0000	1.0000	1.0000	1.0000	1.0000

Police Safety Employees: 3.0% at 50 formula						
From CalPERS Experience Study Report Issued December 2017						
Current	Years of Service					
Age	5	10	15	20	25	30
50	0.0500	0.0500	0.0500	0.1000	0.1550	0.4000
53	0.0400	0.0400	0.0400	0.0800	0.1350	0.3500
56	0.0600	0.0600	0.0600	0.1100	0.1650	0.3300
59	0.0900	0.0900	0.0950	0.1300	0.1850	0.3500
62	0.1500	0.1500	0.1500	0.1500	0.2000	0.3500
65 & over	1.0000	1.0000	1.0000	1.0000	1.0000	1.0000

Police Safety Employees: 3.0% at 55 formula						
From CalPERS Experience Study Report Issued December 2017						
Current	Years of Service					
Age	5	10	15	20	25	30
50	0.0350	0.0350	0.0350	0.0350	0.0700	0.0900
53	0.0280	0.0280	0.0280	0.0430	0.0750	0.1320
56	0.0600	0.0600	0.0600	0.1100	0.1650	0.3300
59	0.0900	0.0900	0.0950	0.1300	0.1850	0.3500
62	0.1500	0.1500	0.1500	0.1500	0.2000	0.3500
65 & over	1.0000	1.0000	1.0000	1.0000	1.0000	1.0000

Police Safety Employees: 2.7% at 57 formula						
From CalPERS Experience Study Report Issued December 2017						
Current	Years of Service					
Age	5	10	15	20	25	30
50	0.0500	0.0500	0.0500	0.0500	0.0500	0.1000
53	0.0380	0.0380	0.0380	0.0380	0.0774	0.1169
56	0.0627	0.0627	0.0627	0.0836	0.1228	0.2168
59	0.0800	0.0800	0.0800	0.0920	0.1400	0.2275
62	0.1500	0.1500	0.1500	0.1500	0.1500	0.2125
65 & over	1.0000	1.0000	1.0000	1.0000	1.0000	1.0000



Supporting Information (Continued)

Section 3 - Actuarial Methods and Assumptions

Service Retirement Rates
(concluded)

Fire Safety Employees: 3.0% at 50 formula						
From CalPERS Experience Study Report Issued December 2017						
Current	Years of Service					
Age	5	10	15	20	25	30
50	0.0200	0.0200	0.0200	0.0400	0.1300	0.1920
53	0.0230	0.0230	0.0230	0.0430	0.1350	0.1980
56	0.0530	0.0530	0.0530	0.0850	0.1960	0.2690
59	0.0750	0.0750	0.0750	0.1160	0.2390	0.3210
62	0.0680	0.0680	0.0680	0.1060	0.2240	0.3040
65 & over	1.0000	1.0000	1.0000	1.0000	1.0000	1.0000

Fire Safety Employees: 2% at 50 formula						
From CalPERS Experience Study Report Issued December 2017						
Current	Years of Service					
Age	5	10	15	20	25	30
50	0.0090	0.0090	0.0090	0.0090	0.0130	0.0200
53	0.0520	0.0520	0.0520	0.0520	0.0790	0.1190
56	0.0830	0.0830	0.0830	0.0830	0.1270	0.1900
59	0.0740	0.0740	0.0740	0.0740	0.1130	0.1700
62	0.0990	0.0990	0.0990	0.0990	0.1520	0.2280
65 & over	1.0000	1.0000	1.0000	1.0000	1.0000	1.0000

Fire Safety Employees: 2.7% at 57 formula						
From CalPERS Experience Study Report Issued December 2017						
Current	Years of Service					
Age	5	10	15	20	25	30
50	0.0065	0.0065	0.0065	0.0065	0.0101	0.0151
53	0.0442	0.0442	0.0442	0.0442	0.0680	0.1018
56	0.0740	0.0740	0.0740	0.0740	0.1140	0.1706
59	0.0729	0.0729	0.0729	0.0729	0.1123	0.1681
62	0.1136	0.1136	0.1136	0.1136	0.1749	0.2618
65 & over	1.0000	1.0000	1.0000	1.0000	1.0000	1.0000



Supporting Information

(Continued)

Section 3 - Actuarial Methods and Assumptions

Termination Rates

These rates reflect the assumed probability that an employee will leave the County in the next 12 months for reasons other than a service or disability retirement or death.

Miscellaneous Employees: Sum of Vested Terminated & Refund Rates From CalPERS Experience Study Report Issued December 2017						
Attained	Years of Service					
Age	0	3	5	10	15	20
15	0.1812	0.0000	0.0000	0.0000	0.0000	0.0000
20	0.1742	0.1193	0.0654	0.0000	0.0000	0.0000
25	0.1674	0.1125	0.0634	0.0433	0.0000	0.0000
30	0.1606	0.1055	0.0615	0.0416	0.0262	0.0000
35	0.1537	0.0987	0.0567	0.0399	0.0252	0.0184
40	0.1468	0.0919	0.0519	0.0375	0.0243	0.0176
45	0.1400	0.0849	0.0480	0.0351	0.0216	0.0168

Police Safety Employees: Sum of Vested Terminated & Refund Rates From CalPERS Experience Study Report Issued December 2017						
Attained	Years of Service					
Age	0	3	5	10	15	20
15	0.1013	0.0000	0.0000	0.0000	0.0000	0.0000
20	0.1013	0.0258	0.0249	0.0000	0.0000	0.0000
25	0.1013	0.0258	0.0249	0.0179	0.0000	0.0000
30	0.1013	0.0258	0.0249	0.0179	0.0109	0.0000
35	0.1013	0.0258	0.0249	0.0179	0.0109	0.0082
40	0.1013	0.0258	0.0249	0.0179	0.0109	0.0082
45	0.1013	0.0258	0.0249	0.0179	0.0109	0.0082

Fire Safety Employees: Sum of Vested Terminated & Refund Rates From CalPERS Experience Study Report Issued December 2017						
Attained	Years of Service					
Age	0	3	5	10	15	20
15	0.1298	0.0000	0.0000	0.0000	0.0000	0.0000
20	0.1298	0.0237	0.0146	0.0000	0.0000	0.0000
25	0.1298	0.0237	0.0146	0.0069	0.0000	0.0000
30	0.1298	0.0237	0.0146	0.0069	0.0052	0.0000
35	0.1298	0.0237	0.0146	0.0069	0.0052	0.0041
40	0.1298	0.0237	0.0146	0.0069	0.0052	0.0041
45	0.1298	0.0237	0.0146	0.0069	0.0052	0.0041



Supporting Information
(Continued)

Changes recognized during the current measurement period:

Trust rate of return and discount rate	Decreased from 6.0% to 5.8%, reflecting updated projections of long term trust returns
Mortality Improvement	The mortality improvement scale was updated from MacLeod Watts Scale 2018 to MacLeod Watts Scale 2020
General Inflation Rate	Decreased from 2.75% to 2.5% per year
Salary Increase	Decreased from 3.25% to 3.0% per year
Medical Trend	Updated to use the Getzen healthcare trend model sponsored by the Society of Actuaries
Implicit Subsidy for Medicare retirees	Following updated guidance provided in Actuarial Standard of Practice #6, we applied age-based premiums and developed an implicit subsidy liability for retirees enrolled in Medicare Supplement plans who are expected to receive benefits in excess of the PEMHCA minimum benefit.
Participation Rate	For active employees eligible only for the PEMHCA minimum benefit in retirement, the percentage of those currently waiving who are assumed to elect coverage in retirement was decreased from 50% to 30%, following a review of recent plan experience.
Spouse Coverage	For active employees eligible only for the PEMHCA minimum benefit in retirement, the percentage assumed to elect coverage for a spouse in retirement was increased from 40% to 50%, based on a review of recent retiree elections.
Excise tax on High-cost Coverage	Removed after this tax was repealed in December 2019 repeal of this provision of the Affordable Care Act.



Addendum 1: Important Background Information

General Types of Other Post-Employment Benefits (OPEB)

Post-employment benefits other than pensions (OPEB) comprise a part of compensation that employers offer for services received. The most common OPEB are medical, prescription drug, dental, vision, and/or life insurance coverage. Other OPEB may include outside group legal, long-term care, or disability benefits outside of a pension plan. OPEB does not generally include COBRA, vacation, sick leave (unless converted to defined benefit OPEB), or other direct retiree payments.

A direct employer payment toward the cost of OPEB benefits is referred to as an “explicit subsidy”. In addition, if claims experience of employees and retirees are pooled when determining premiums, retiree premiums are based on a pool of members which, on average, are younger and healthier. For certain types of coverage such as medical insurance, this results in an “implicit subsidy” of retiree premiums by active employee premiums since the retiree premiums are lower than they would have been if retirees were insured separately. GASB 75 and Actuarial Standards of Practice generally require that an implicit subsidy of retiree premium rates be valued as an OPEB liability.

Expected retiree claims		
Premium charged for retiree coverage		Covered by higher active premiums
Retiree portion of premium	Agency portion of premium Explicit subsidy	Implicit subsidy

This chart shows the sources of funds needed to cover expected medical claims for pre-Medicare retirees. The portion of the premium paid by the County does not impact the amount of the implicit subsidy.

Valuation Process

The valuation was based on employee census data and benefits provided by the County. A summary of the employee data is provided in Section 1 and a summary of the benefits provided under the Plan is provided in Section 2. While individual employee records have been reviewed to verify that they are reasonable in various respects, the data has not been audited and we have otherwise relied on the County as to its accuracy. The valuation was also based on the actuarial methods and assumptions described in Section 3.

In developing the projected benefit values and liabilities, we first determine an expected premium or benefit stream over the employee’s future retirement. Benefits may include both direct employer payments (explicit subsidies) and/or an implicit subsidy, arising when retiree premiums are expected to be subsidized by active employee premiums. The projected benefit streams reflect assumed trends in the cost of those benefits and assumptions as to the expected date(s) when benefits will end. We then apply assumptions regarding:

- The probability that each individual employee will or will not continue in service to receive benefits.
- The probability of when such retirement will occur for each retiree, based on current age, service and employee type; and
- The likelihood that future retirees will or will not elect retiree coverage (and benefits) for themselves and/or their dependents.



Important Background Information

(Continued)

We then calculate a present value of these benefits by discounting the value of each future expected benefit payment, multiplied by the assumed expectation that it will be paid, back to the valuation date using the discount rate. These benefit projections and liabilities have a very long time horizon. The final payments for currently active employees may not be made for many decades.

The resulting present value for each employee is allocated as a level percent of payroll each year over the employee's career using the entry age normal cost method and the amounts for each individual are then summed to get the results for the entire plan. This creates a cost expected to increase each year as payroll increases. Amounts attributed to prior fiscal years form the "Total OPEB Liability". The OPEB cost allocated for active employees in the current year is referred to as "Service Cost".

Where contributions have been made to an irrevocable OPEB trust, the accumulated value of trust assets ("Fiduciary Net Position") is applied to offset the "Total OPEB Liability", resulting in the "Net OPEB Liability". If a plan is not being funded, then the Net OPEB Liability is equal to the Total OPEB Liability.

It is important to remember that an actuarial valuation is, by its nature, a projection of one possible future outcome based on many assumptions. To the extent that actual experience is not what we assumed, future results will differ. Some possible sources of future differences may include:

- A significant change in the number of covered or eligible plan members
- A significant increase or decrease in the future premium rates
- A change in the subsidy provided by the County toward retiree premiums
- Longer life expectancies of retirees
- Significant changes in expected retiree healthcare claims by age, relative to healthcare claims for active employees and their dependents
- Higher or lower returns on plan assets or contribution levels other than were assumed, and/or
- Changes in the discount rate used to value the OPEB liability



Important Background Information (Continued)

Requirements of GASB 75

The Governmental Accounting Standards Board (GASB) issued GASB Statement No. 75, *Accounting and Financial Reporting by Employers for Postemployment Benefits Other Than Pensions*. This Statement establishes standards for the measurement, recognition, and disclosure of OPEB expense and related liabilities (assets), note disclosures, and, required supplementary information (RSI) in the financial reports of state and local governmental employers.

Important Dates

GASB 75 requires that the information used for financial reporting falls within prescribed timeframes. Actuarial valuations of the total OPEB liability are generally required at least every two years. If a valuation is not performed as of the Measurement Date, then liabilities are required to be based on roll forward procedures from a prior valuation performed no more than 30 months and 1 day prior to the most recent year-end. In addition, the net OPEB liability is required to be measured as of a date no earlier than the end of the prior fiscal year (the "Measurement Date").

Recognition of Plan Changes and Gains and Losses

Under GASB 75, gains and losses related to changes in Total OPEB Liability and Fiduciary Net Position are recognized in OPEB expense systematically over time.

- *Timing of recognition:* Changes in the Total OPEB Liability relating to changes in plan benefits are recognized immediately (fully expensed) in the year in which the change occurs. Gains and Losses are amortized, with the applicable period based on the type of gain or loss. The first amortized amounts are recognized in OPEB expense for the year the gain or loss occurs. The remaining amounts are categorized as deferred outflows and deferred inflows of resources related to OPEB and are to be recognized in future OPEB expense.
- *Deferred recognition periods:* These periods differ depending on the source of the gain or loss.

Difference between projected
and actual trust earnings:

5 year straight-line recognition

All other amounts:

Straight-line recognition over the expected average remaining service lifetime (EARSL) of all members that are provided with benefits, determined as of the beginning of the Measurement Period. In determining the EARSL, all active, retired and inactive (vested) members are counted, with the latter two groups having 0 remaining service years.



Important Background Information
(Continued)

Implicit Subsidy Plan Contributions

An implicit subsidy occurs when expected retiree claims exceed the premiums charged for retiree coverage. When this occurs, we expect part of the premiums paid for active employees to cover a portion of retiree claims. This transfer represents the current year’s “implicit subsidy”. Because GASB 75 treats payments to an irrevocable trust *or directly to the insurer* as employer contributions, each year’s implicit subsidy is treated as a contribution toward the payment of retiree benefits.

The following hypothetical example illustrates this treatment:

Hypothetical Illustration of Implicit Subsidy Recognition	For Active Employees	For Retired Employees
<i>Prior to Implicit Subsidy Adjustment</i>		
Premiums Paid by Agency During Fiscal Year	\$ 411,000	\$ 48,000
Accounting Treatment	Compensation Cost for Active Employees	Contribution to Plan & Benefits Paid from Plan
<i>After Implicit Subsidy Adjustment</i>		
Premiums Paid by Agency During Fiscal Year	\$ 411,000	\$ 48,000
Implicit Subsidy Adjustment	(23,000)	23,000
Accounting Cost of Premiums Paid	\$ 388,000	\$ 71,000
Accounting Treatment Impact	Reduces Compensation Cost for Active Employees	Increases Contributions to Plan & Benefits Paid from Plan

The example above shows that total payments toward active and retired employee healthcare premiums is the same, but for accounting purposes part of the total is shifted from actives to retirees. This shifted amount is recognized as an OPEB contribution and reduces the current year’s premium expense for active employees.



Important Background Information
(Continued)

Discount Rate

When the financing of OPEB liabilities is on a pay-as-you-go basis, GASB 75 requires that the discount rate used for valuing liabilities be based on the yield or index rate for 20-year, tax-exempt general obligation municipal bonds with an average rating of AA/Aa or higher (or equivalent quality on another rating scale). When a plan sponsor makes regular, sufficient contributions to a trust in order to prefund the OPEB liabilities, GASB 75 allows use of a rate up to the expected rate of return of the trust. Therefore, prefunding has an advantage of potentially being able to report overall lower liabilities due to future expected benefits being discounted at a higher rate.

Actuarial Funding Method and Assumptions

The “ultimate real cost” of an employee benefit plan is the value of all benefits and other expenses of the plan over its lifetime. These expenditures are dependent only on the terms of the plan and the administrative arrangements adopted, and as such are not affected by the actuarial funding method.

The actuarial funding method attempts to spread recognition of these expected costs on a level basis over the life of the plan, and as such sets the “incidence of cost”. GASB 75 specifically requires that the actuarial present value of projected benefit payments be attributed to periods of employee service using the Entry Age Actuarial Cost Method, with each period’s service cost determined as a level percentage of pay.

The results of this report may not be appropriate for other purposes, where other assumptions, methodology and/or actuarial standards of practice may be required or more suitable.



Addendum 2: MacLeod Watts Age Rating Methodology

Both accounting standards (e.g. GASB 75) and actuarial standards (e.g. ASOP 6) require that expected retiree claims, not just premiums paid, be reflected in most situations where an actuary is calculating retiree healthcare liabilities. Unfortunately, the actuary is often required to perform these calculations without any underlying claims information. In most situations, the information is not available, but even when available, the information may not be credible due to the size of the group being considered.

Actuaries have developed methodologies to approximate healthcare claims from the premiums being paid by the plan sponsor. Any methodology requires adopting certain assumptions and using general studies of healthcare costs as substitutes when there is a lack of credible claims information for the specific plan being reviewed.

Premiums paid by sponsors are often uniform for all employee and retiree ages and genders, with a drop in premiums for those participants who are Medicare-eligible. While the total premiums are expected to pay for the total claims for the insured group, on average, the premiums charged would not be sufficient to pay for the claims of older insureds and would be expected to exceed the expected claims of younger insureds. An age-rating methodology takes the typically uniform premiums paid by plan sponsors and spreads the total premium dollars to each age and gender intended to better approximate what the insurer might be expecting in actual claims costs at each age and gender.

The process of translating premiums into expected claims by age and gender generally follows the steps below.

1. *Obtain or Develop Relative Medical Claims Costs by Age, Gender, or other categories that are deemed significant.* For example, a claims cost curve might show that, if a 50 year old male has \$1 in claims, then on average a 50 year old female has claims of \$1.25, a 30 year male has claims of \$0.40, and an 8 year old female has claims of \$0.20. The claims cost curve provides such relative costs for each age, gender, or any other significant factor the curve might have been developed to reflect. Section 3 provides the source of information used to develop such a curve and shows sample relative claims costs developed for the plan under consideration.
2. *Obtain a census of participants, their chosen medical coverage, and the premium charged for their coverage.* An attempt is made to find the group of participants that the insurer considered in setting the premiums they charge for coverage. That group includes the participant and any covered spouses and children. When information about dependents is unavailable, assumptions must be made about spouse age and the number and age of children represented in the population. These assumptions are provided in Section 3.
3. *Spread the total premium paid by the group to each covered participant or dependent based on expected claims.* The medical claims cost curve is used to spread the total premium dollars paid by the group to each participant reflecting their age, gender, or other relevant category. After this step, the actuary has a schedule of expected claims costs for each age and gender for the current premium year. It is these claims costs that are projected into the future by medical cost inflation assumptions when valuing expected future retiree claims.

The methodology described above is dependent on the data and methodologies used in whatever study might be used to develop claims cost curves for any given plan sponsor. These methodologies and assumptions can be found in the referenced paper cited as a source in the valuation report.



Addendum 3: MacLeod Watts Mortality Projection Methodology

Actuarial standards of practice (e.g., ASOP 35, Selection of Demographic and Other Noneconomic Assumptions for Measuring Pension Obligations, and ASOP 6, Measuring Retiree Group Benefits Obligations) indicate that the actuary should reflect the effect of mortality improvement (i.e., longer life expectancies in the future), both before and after the measurement date. The development of credible mortality improvement rates requires the analysis of large quantities of data over long periods of time. Because it would be extremely difficult for an individual actuary or firm to acquire and process such extensive amounts of data, actuaries typically rely on large studies published periodically by organizations such as the Society of Actuaries or Social Security Administration.

As noted in a recent actuarial study on mortality improvement, key principles in developing a credible mortality improvement model would include the following:

- (1) Short-term mortality improvement rates should be based on recent experience.
- (2) Long-term mortality improvement rates should be based on expert opinion.
- (3) Short-term mortality improvement rates should blend smoothly into the assumed long-term rates over an appropriate transition period.

The **MacLeod Watts Scale 2020** was developed from a blending of data and methodologies found in two published sources: (1) the Society of Actuaries Mortality Improvement Scale MP-2019 Report, published in October 2019 and (2) the demographic assumptions used in the 2019 Annual Report of the Board of Trustees of the Federal Old-Age and Survivors Insurance and Federal Disability Insurance Trust Funds, published April 2019.

MacLeod Watts Scale 2020 is a two-dimensional mortality improvement scale reflecting both age and year of mortality improvement. The underlying base scale is Scale MP-2019 which has two segments – (1) historical improvement rates for the period 1951-2015 and (2) an estimate of future mortality improvement for years 2016-2018 using the Scale MP-2019 methodology but utilizing the assumptions obtained from Scale MP-2015. The MacLeod Watts scale then transitions from the 2018 improvement rate to the Social Security Administration (SSA) Intermediate Scale linearly over the 10-year period 2019-2028. After this transition period, the MacLeod Watts Scale uses the constant mortality improvement rate from the SSA Intermediate Scale from 2028-2042. The SSA's Intermediate Scale has a final step down in 2043 which is reflected in the MacLeod Watts scale for years 2043 and thereafter. Over the ages 95 to 115, the SSA improvement rate is graded to zero.

Scale MP-2019 can be found at the SOA website and the projection scales used in the 2019 Social Security Administrations Trustees Report at the Social Security Administration website.



Glossary

Actuarial Funding Method – A procedure which calculates the actuarial present value of plan benefits and expenses, and allocates these expenses to time periods, typically as a normal cost and an actuarial accrued liability

Actuarial Present Value of Projected Benefits (APVPB) – The amount presently required to fund all projected plan benefits in the future. This value is determined by discounting the future payments by an appropriate interest rate and the probability of nonpayment.

CalPERS – Many state governments maintain a public employee retirement system; CalPERS is the California program, covering all eligible state government employees as well as other employees of other governments within California who have elected to join the system

Defined Benefit (DB) – A pension or OPEB plan which defines the monthly income or other benefit which the plan member receives at or after separation from employment

Deferred Contributions – When an employer makes contributions after the measurement date and prior to the fiscal year end, recognition of these contributions is deferred to a subsequent accounting period by creating a deferred resource. We refer to these contributions as Deferred Contributions.

Defined Contribution (DC) – A pension or OPEB plan which establishes an individual account for each member and specifies how contributions to each active member’s account are determined and the terms of distribution of the account after separation from employment

Discount Rate - Interest rate used to discount future potential benefit payments to the valuation date. Under GASB 75, if a plan is prefunded, then the discount rate is equal to the expected trust return. If a plan is not prefunded (pay-as-you-go), then the rate of return is based on a yield or index rate for 20-year, tax-exempt general obligation municipal bonds with an average rating of AA/Aa or higher.

Expected Average Remaining Service Lifetime (EARSL) – Average of the expected remaining service lives of all employees that are provided with benefits through the OPEB plan (active employees and inactive employees), beginning in the current period

Entry Age Actuarial Cost Method – An actuarial funding method where, for each individual, the actuarial present value of benefits is levelly spread over the individual’s projected earnings or service from entry age to the last age at which benefits can be paid

Excise Tax – The Affordable Care Act created an excise tax on the value of employer sponsored coverage which exceeds certain thresholds (“Cadillac Plans”). This tax was repealed in December 2019, before ever going into effect.

Explicit Subsidy – The projected dollar value of future retiree healthcare costs expected to be paid directly by the Employer, e.g., the Employer’s payment of all or a portion of the monthly retiree premium billed by the insurer for the retiree’s coverage

Fiduciary Net Position –The value of trust assets used to offset the Total OPEB Liability to determine the Net OPEB Liability.

Government Accounting Standards Board (GASB) – A private, not-for-profit organization which develops generally accepted accounting principles (GAAP) for U.S. state and local governments; like FASB, it is part of the Financial Accounting Foundation (FAF), which funds each organization and selects the members of each board



Glossary
(Continued)

Health Care Trend – The assumed rate(s) of increase in future dollar values of premiums or healthcare claims, attributable to increases in the cost of healthcare; contributing factors include medical inflation, frequency or extent of utilization of services and technological developments.

Implicit Subsidy – The projected difference between future retiree claims and the premiums to be charged for retiree coverage; this difference results when the claims experience of active and retired employees are pooled together and a ‘blended’ group premium rate is charged for both actives and retirees; a portion of the active employee premiums subsidizes the retiree premiums.

Net OPEB Liability (NOL) – The liability to employees for benefits provided through a defined benefit OPEB. Only assets administered through a trust that meet certain criteria may be used to reduce the Total OPEB Liability.

Net Position – The Impact on Statement of Net Position is the Net OPEB Liability adjusted for deferred resource items

OPEB Expense – The OPEB expense reported in the agency’s financial statement. OPEB expense is the annual cost of the plan recognized in the financial statements.

Other Post-Employment Benefits (OPEB) – Post-employment benefits other than pension benefits, most commonly healthcare benefits but also including life insurance if provided separately from a pension plan

Pay-As-You-Go (PAYGO) – Contributions to the plan are made at about the same time and in about the same amount as benefit payments and expenses coming due

PEMHCA – The Public Employees’ Medical and Hospital Care Act, established by the California legislature in 1961, provides community-rated medical benefits to participating public employers. Among its extensive regulations are the requirements that a contracting agency contribute toward medical insurance premiums for retired annuitants and that a contracting agency file a resolution, adopted by its governing body, with the CalPERS Board establishing any new contribution.

Plan Assets – The value of cash and investments considered as ‘belonging’ to the plan and permitted to be used to offset the AAL for valuation purposes. To be considered a plan asset, GASB 75 requires (a) contributions to the OPEB plan be irrevocable, (b) OPEB assets to dedicated to providing OPEB benefit to plan members in accordance with the benefit terms of the plan, and (c) plan assets be legally protected from creditors, the OPEB plan administrator and the plan members.

Public Agency Miscellaneous (PAM) – Non-safety public employees.

Select and Ultimate – Actuarial assumptions which contemplate rates which differ by year initially (the select period) and then stabilize at a constant long-term rate (the ultimate rate)

Service Cost – Total dollar value of benefits expected to be earned by plan members in the current year, as assigned by the actuarial funding method; also called normal cost

Total OPEB Liability (TOL) – Total dollars required to fund all plan benefits attributable to service rendered as of the valuation date for current plan members and vested prior plan members; a subset of “Actuarial Present Value”

Vesting – As defined by the plan, requirements which when met make a plan benefit nonforfeitable on separation of service before retirement eligibility





OFFICE OF THE CLERK
OF THE BOARD OF SUPERVISORS

REGULAR AGENDA REQUEST

Print

MEETING DATE January 18, 2022

Departments: Community Development

TIME REQUIRED 20 minutes

**PERSONS
APPEARING
BEFORE THE
BOARD**

Wendy Sugimura, Community
Development Director

SUBJECT Letter to the Board of Forestry and
Fire Protection Regarding the 2021
State Minimum Fire Safe Regulations

AGENDA DESCRIPTION:

(A brief general description of what the Board will hear, discuss, consider, or act upon)

Proposed comment letter to the Board of Forestry and Fire Protection (BOF) regarding the November 22 Draft of the State Minimum Fire Safe Regulations. The BOF initiated a 15-day comment period on January 3 and written comments are due Wednesday January 19, 2022.

RECOMMENDED ACTION:

1) Review and discuss draft comment letter, provide direction to staff regarding revisions to the finalization of the letter; 2) Approve with any desired modifications and authorize the Chair to sign; 3) Direct staff to submit the approved letter by January 19 deadline.

FISCAL IMPACT:

None.

CONTACT NAME: Kelly Karl

PHONE/EMAIL: 7609241809 / kkarl@mono.ca.gov

SEND COPIES TO:

MINUTE ORDER REQUESTED:

YES NO

ATTACHMENTS:

Click to download
Staff Report
Draft Comment Letter
Notice
Proposed Rule Text

History

Time	Who	Approval
1/13/2022 11:07 AM	County Counsel	Yes
1/13/2022 12:51 PM	Finance	Yes
1/14/2022 3:16 PM	County Administrative Office	Yes

Mono County Community Development Department

P.O. Box 347
Mammoth Lakes, CA 93546
(760) 924-1800, fax 924-1801
commdev@mono.ca.gov

Planning Division

P.O. Box 8
Bridgeport, CA 93517
(760) 932-5420, fax 932-5431
www.monocounty.ca.gov

January 18, 2022

To: Honorable Chair and Members of the Board of Supervisors

From: Kelly Karl, Associate Planner
Emily Fox, Deputy County Counsel
April Sall, Planning Analyst
Wendy Sugimura, Community Development Director

Re: Board of Forestry & Fire Protection's January Draft State Minimum Fire Safe Regulations 2022

RECOMMENDED ACTION

1. Review and discuss draft comment letter, provide direction to staff regarding revisions to and finalization of the letter;
2. Direct staff to submit the approved letter by the January 19 deadline, and provide direction on making public comment on at the January 19 Board of Forestry public hearing.

FISCAL IMPACT

Fiscal impact is associated with increased staff time to understand and administer the new regulations. Future fiscal impacts to the County overall may include severe building construction limitations in areas of the county that cannot meet the new fire safe standards.

BACKGROUND

The Board of Forestry and Fire Protection (BOF) is required under Public Resources Code (PRC) §4290 to adopt minimum fire safety standards for State Responsibility Areas (SRAs) that are applicable to “the perimeters and access to all residential, commercial, and industrial building construction.” The State Minimum Fire Safe Regulations (MFSRs) were established January 1, 1991, and created baseline standards for road access, road and building signage, minimum emergency water supplies, and fuel breaks/greenbelts. In September 2018, the California Legislature passed Senate Bill 901 which expanded the applicability of MFSRs to Local Responsibility Areas (LRAs) in Very High Fire Hazard Severity Zones (VHFHSZs) starting July 1, 2021. In addition, SB 901 also required the BOF to increase the frequency of updates relating to fuel breaks/greenbelts near communities as well as preserve undeveloped ridgelines to reduce fire risk.

DISCUSSION

The BOF initiated the Informal Scoping process for a comprehensive update to the MFSRs in November 2020 and hosted a number of workshops in 2020 and 2021 for members of the public and local jurisdictions to participate in the rulemaking process. In March, the BOF released its third draft of the MFSRs and indicated that the BOF would be authorizing initiation of a 45-day comment period on the 2021 MFSR. The BOF announcement gave jurisdictions very little time

to review the new and previously unreleased version of the MFSR and prepare verbal/written comments for the March 22, 2021, BOF meeting. The BOF received an outpouring of comments from jurisdictions during that meeting concerned with the language proposed in latest version of the MFSR. Mono County submitted written comments and Supervisor Kreitz, who was Board Chair at the time, and Chief Administrative Officer, Robert Lawton, provided verbal testimony at the March and June public hearings.

An updated draft of the proposed MFSR text was released following the BOF's December 8 meeting, which included substantive updates and some of Mono County's requested changes. A "Notice of Addition of Documents and Information to Rulemaking File and Modified Text" was published January 3 and initiated a formal 15-day public comment period. The comment period ends January 19, 2022, after which the BOF may choose to either adopt the January MFSRs or initiate another 15-day comment period to allow for additional revision to the 2022 MFSRs.

The notice of public hearing to consider adoption of the MFSR is not yet available. Pending Board direction, staff will coordinate with the selected speaker(s) when the date is known.

Please contact Wendy Sugimura at 760-924-1814 or wsugimura@mono.ca.gov with any questions.

ATTACHMENTS

1. Draft 2022 MFSR Comment Letter
2. 15-Day Notice of Proposed Addition of Documents and Information to Rulemaking File and Modified Text
3. January 2022 Proposed Rule Text for State Minimum Fire Safe Standards

Mono County Community Development Department

PO Box 347
Mammoth Lakes CA, 93546
760.924.1800, fax 924.1801
commdev@mono.ca.gov

Planning Division

PO Box 8
Bridgeport, CA 93517
(760) 932-5420, fax 932-5431
www.monocounty.ca.gov

January 18, 2022

Board of Forestry and Fire Protection
Attn: Ms. Edith Hannigan
Executive Officer
PO Box 944246
Sacramento, CA 94244-2460

Submitted via email to PublicComments@bof.ca.gov and edith.hannigan@bof.ca.gov

Dear Board of Forestry and Fire Protection:

The Mono County Board of Supervisors appreciates the opportunity to comment on the Notice of Proposed Action “State Minimum Fire Safe Regulations, 2021.” As an active participant in the Informal Scoping process for the 2022 Minimum Fire Safe Regulations (“MFSRs”) since November 2020, Mono County (“the County”) has the same interest as the Board of Forestry and Fire Protection (“BOF”) in reducing loss of life and property from catastrophic fires. The updated text released as part of the 15-Day “Notice of Addition of Documents and Information to Rulemaking File and Modified Text” on December 8, 2021, contains substantial edits and initiated a 15-day comment period following the January 3, 2022, publication of the Notice. In the text below, the County highlights several significant issues with the January 2022 draft of the MFSRs and offers, in good faith, specific textual edits as potential solutions to these issues. Our comments are intended to be constructive while also conveying the seriousness of potential impacts. All previous written and verbal comments from Mono County on these draft regulations are incorporated herein by reference.

I. Article 1 – Administration

A. Clarifying Definitions

- The definition of the “Authority Having Jurisdiction (AHJ)” and the subsequent sections citing the AHJ are unclear and will result in poor coordination between jurisdictions, potential legal disagreements and ultimately, poor implementation. The intended AHJ should be clarified where this term is used prior to adoption of the MFSR. The intended AHJ is clear in §1270.03(e), 1270.03(h), 1270.05, 1270.06, however, all other AHJ references are confusing and need further clarification. Additionally, even in the sections where the AHJ is clearly identified, potential scenarios exist where two different entities qualify as the AHJ. For example, Mono County is the inspection authority under §1270.03(e) and CAL FIRE/BOF is the inspection authority under §1270.05. For granting

exceptions, this inconsistency creates a conflict between potential AHJs and should be remedied prior to finalizing the 2022 MFSR.

- The definition of “Building Construction” includes subdivisions which, as the Commission is aware, consists of creating new parcels on a map and may not result in the immediate construction of any structures. To include the creation of parcels on a map in the definition of “building construction” is inconsistent with standard planning practices and will create confusion and often oversight. Mono County has subdivision maps that were finalized 20+ years ago and no structures have yet been built. Where the intent is to apply regulations to subdivisions, it should just be stated as such rather than burying the application to subdivisions in a separate and unexpected definition, which will cause confusion and implementation problems.
- The definition of “Driveway” may not allow for the density outright permitted on multifamily residential parcels or where density has been increased to comply with state housing directives. The result would require these types of parcels to upgrade a Driveway to a Road, which is an unnecessary burden on housing development and in direct conflict with State housing directives. A modification to the definition of a Driveway would increase the consistency between state housing directives and multifamily residential permitted uses. Other proposed changes below are consistent with RCRC’s suggestions in its 2021 comment letter.

“Driveway: A vehicular pathway that serves no more than ~~four (4) Residential Units~~ the maximum number of units permitted explicitly by local land use regulations on those parcels and any number of non-commercial or non-industrial Storage Group S Utility or Miscellaneous Group U Buildings on each parcel. A Driveway shall not serve commercial or industrial uses ~~at any size or scale~~ of more than 7,200 square feet.”

- To be consistent with the definition of Driveway, the following modification to the definition of Road is proposed:

“Road: A public or private vehicular pathway to more than ~~four (4) Residential Units~~ the maximum number of units permitted explicitly by local land use regulations on those parcels, or to any industrial or commercial Occupancy of more than 7,200 square feet.”¹

- The proposed definition of “Residential Unit” is based on the intention of the applicant (i.e., whether they intend to sleep in a space or not), which is often impossible to determine accurately and difficult to enforce, rather than objective physical features of construction. It is also inconsistent with the definition of a “dwelling unit” and therefore a residential occupancy under the California Building Code (CBC). For consistency and to simplify application, which will

¹ Partially aligns with language suggested by RCRC in 2021 comment letter.

increase the success of implementation and reduce confusion, use the definition of a “dwelling unit” already established in the CBC: *A single unit providing complete independent living facilities for one or more persons, including permanent provisions for living, sleeping, eating, cooking, and sanitation.* To further illustrate the point, the current definition could apply to a wood platform with uninsulated walls/roof and no door, similar to a backcountry sleeping shelter, which does not seem appropriate.

B. Applicability and Parcels Approved Prior to 1991

A transition period in alignment with the adoption date of the 2022 MFSRs is needed to ensure a smooth transition for projects currently being processed and those that are currently in the design phase. Application of new standards to building permits that have already been accepted as complete and are in the plan check process may necessitate expensive re-design that was not due to any fault of the applicant.

Further, ambiguity in proposed section §1270.03 relating to parcels approved in a pre-1991 parcel or tentative map renders it difficult, if not impracticable, to apply. This section can be interpreted in two ways, that this exemption applies to 1) all pre-1991 maps or 2) only to pre-1991 maps on parcels that have constructed the infrastructure required by the map. Mono County recommends that the language of this exemption be updated to apply to all parcels with pre-1991 maps.

C. Exceptions

CAL FIRE is currently the AHJ in Mono County, and applicants and staff find requests for exemptions and will-serve letters for projects under the existing regulations to be extraordinarily onerous due to lack of response. In some cases, building permits have been held up for extended time periods while awaiting a response. The additional approval process associated with exceptions would significantly delay the processing and implementation of planning and building permits for both commercial and residential projects which would negatively impact the County’s economic base, future housing stock, and fire victim housing security.

Suggested Solutions

- 2A. See proposed language changes included in the “Definitions” section.
- 2B. Add specified timeframes to §1270.06 “Exceptions to Standards” within which the inspection authority must respond to a request for an exception, otherwise the exception is deemed granted. To be consistent with ministerial building permit plan checks timeframes in Mono County, the deemed granted timeframe should be less than 30 days. Longer timeframes have the potential to delay ministerial building permit processing and efforts to rebuild communities after a wildfire.

(f) Approvals or denials of an exception request shall be made in writing to the applicant or the applicant’s authorized representative within 30 days of the postal or electronic mailing date. If the exception is denied, the written response shall state the

basis for denial. If no response is provided, the exception is deemed approved upon expiration of the 30-day response period.

- 2C. A transition period in alignment with the adoption date of the 2022 MFSRs is needed to ensure a smooth transition for projects currently being processed and those that are currently in the design phase. The County suggests that the MFSRs should apply to new proposals submitted after the approval date of the 2022 MFSRs, to allow projects with applications submitted prior to the approval date to proceed unencumbered by the new regulations.
- 2D. Update all exemptions for pre-1991 parcels to mean any parcel approved from a pre-1991 parcel or tentative map and strike language referencing to conditions to Perimeters and Access to the Buildings.

§1270.03(a)(3) applications for Building permits on a parcel approved in a pre-1991 parcel or tentative map. ~~to the extent that conditions relating to the Perimeters and Access to the Buildings were not imposed as part of the approval of the parcel or tentative map.~~

§1270.03.(b) This exemption shall apply only to the extent that the parcel map or tentative map ~~that was approved prior to January 1, 1991. imposed conditions relating to the Perimeters and Access to the Building Construction that is the subject of the Building permit application filed after January 1, 1991.~~

II. Article 2 – Ingress and Egress

Several potentially impactful ambiguities remain in the latest draft of the regulations in Article 2 that could disproportionately burden minor development projects and pose prohibitive obstacles to development of smaller housing projects on the 6% of available land for private development in Mono County and would be in direct conflict with state policy and directives to local jurisdictions to increase housing supply.

A. Issues with the updated “Existing Roads” standards generally

Mono County appreciates that changes have been made to this Article, particularly with respect to standards that apply to “existing roads” vs. “new roads.” However, these references are unclear in some cases where neither “existing” nor “new” are specified in the regulations. For example, sections 1273.01, 1273.02, 1273.03(d)(e), 1273.06, 1273.09, 1273.10, and 1273.11 create ambiguity for local jurisdictions to interpret whether these additional standards apply to “Existing Roads” because they are not explicitly limited to “New Roads.” The language in the above referenced sections needs to be updated to specify explicitly whether they apply to “New” or “Existing Roads” before the MFSR are finalized.

The County appreciates the removal of §1273.00(d) from the previous draft that prohibited building construction on roads that do not meet the “Existing Roads” standards. The elimination of this language appears to correct the presumably unintended consequence of

creating a de facto moratorium on any building construction in cases where meeting the existing road standards is infeasible. However, the three thresholds established in §1273.00(c)(1-3), which specifies when the MFSRs existing road and driveway standards apply, remains problematic due to unnecessary complexity that reduces the likelihood of successful implementation, vagueness, and applicability to very minor projects. Rather than create random new standards, existing standards such as the threshold separating a parcel map (up to four parcels) and a tract map (more than four parcels) and California Environmental Quality Act (CEQA) exemptions should be utilized to simplify regulations and facilitate implementation. Further, the threshold for increased density and use intensity is extremely vague. For example, in Mono County, would a proposed zoning change from Rural Residential (RR) to Agricultural (AG) trigger the road standard under §1273.00(c)(2)? Generally, such a zoning change is a decrease in density unless farm labor housing is constructed, but may be considered an increase in intensity due to increased surface disturbance and the potentially commercial nature of an agricultural operation. Who will clarify for the County whether the threshold is triggered? The BOF needs to create specific parameters for triggering “increased intensity,” otherwise local jurisdictions are left with the most conservative interpretation that any increase in intensity above baseline would trigger these standards. This conservative interpretation does not seem to meet the intent indicated in the initial sections of Article 2. Finally, under Mono County zoning regulations, the threshold under §1273.00(c)(3) will be triggered for minor projects such as a <2,500 square-foot kitchen or seating expansion at a local restaurant or a second dwelling unit (other than an accessory dwelling unit) in a residential zone. These projects would normally be exempt under CEQA and therefore relatively simple to process. If extensive access road upgrades are required, however, the project could easily trigger more extensive environmental analysis, which could include a hefty price tag and a significant investment of time.

The County remains concerned that these “Existing Roads” standards are disproportionate to the impact of these minor developments, are unreasonably prohibitive for new housing developments, are in direct conflict with both State housing directives to increase housing stock and Mono County General Plan policies to promote compact development within existing communities and may not be legally defensible. These requirements may expose counties to legal liability by forcing the imposition of disproportionate exactions under the Nollan-Dolan standards articulated in *Dolan v. City of Tigard*, 512 E.S. 374 (1994). Furthermore, depending on existing road configuration, established right of way, and ownership patterns or environmental constraints adjacent to the road, these increased standards and dimensions may not be possible which would result in a de-facto moratorium for all properties along the subject road except for low-density, individual single-family residential development.

As currently written the “Existing Roads” standards do not appear to allow for any exceptions or flexibility for scenarios where application of these standards would be impossible due to site limitations or ownership patterns. Thus, language should be added to the 14-foot traffic lane requirement to allow for scenarios where site conditions make it impossible to meet this standard. A cross-reference to “§1270.06 Exceptions” should also be added to make it clear

that exceptions to the “Existing Roads” standards are permitted pursuant to that section. As currently written, the standards do not appear to allow for any exception.

Depending on whether the access in question is public or private, the burden of upgrades could fall to the County or a private property owner. If the burden falls to private property owners, imposition of existing road standards in both a wildfire rebuild scenario as well as a typical residential development scenario would render the construction of new housing stock and the reconstruction of residential structures destroyed in a disaster financially infeasible (which would result in a net loss of available housing and displaced survivors). These standards create a barrier to meeting State housing directives and all but the wealthiest property owners would be priced out of constructing or rebuilding a residence. The burdens of these regulations would exacerbate existing environmental justice and equity issues associated with California’s housing crisis. The language in this section of the MFSRs must be updated to ensure that the burden of these safety standards is distributed in a just and equitable manner for all Californians.

If the burden of road upgrades falls to the County, the potential environmental impacts of modifying all deficient access to meet these standards will be significant and, depending on the property’s configuration, ownership, and any topographical constraints, implementing increased road dimensions and standards may not be feasible or legally possible. The only option available to local jurisdictions to conform to MFSR standards may be eminent domain, which is likely to result in prolonged legal challenges in addition to the prohibitive costs associated with bringing existing roads up to standard. The potential legal matters resulting from takings claims and/or eminent domain, the prohibitive costs of upgrades, and the potential inability to conform in general due to existing constraints results in a de facto moratorium in certain areas of the county and direct conflict with state housing policies and directives.

The bottom line is that the MFSR standards should not require upgrades to existing roads for previously approved projects, outright permitted uses, or projects qualifying for CEQA exemptions.

Suggested Solutions

- 2A. Modify the following sections (§1273.01; § 1273.02; §1273.03(d)(e); §1273.06; §1273.09; §1273.10; and §1273.11) to specifically apply to New Roads. Based on those changes, further modify the “Existing Roads” standards in §1273.12 to explicitly list or cross-reference these additional requirements.

*§1273.01. Horizontal and Vertical Curves / Curb Radii at **New** Intersections*

*(a) **New** Road or **New** appurtenant surface shall have a horizontal inside radius of curvature (measured from the centerline of the inside lane) of less than fifty (50) feet, except as provided for in subsections (b), (c), and (d).*

*(1) An additional four (4) feet of surface width shall be added to the required widths in § 1273.05 (**New** Road and **New** Driveway Traffic Lane Width and Clear Width) to curves of 50-100 feet radius.*

(2) One (1) foot of additional *New Road* width shall be added to curves of 100-200 feet, as illustrated on Figure 1 and Figure 2.

(3) Flexible posts may be placed within the required radius.

(b) Where the operating speed of a *New Road* is 15 miles per hour (mph) or less, an alternative standard to subsection (a) based on modeling performed by a Professional Engineer, as described within the Professional Engineers Act (Chapter 7 of Division 3 of the Business and Professions Code), that demonstrates Fire Apparatus can negotiate the proposed horizontal inside radius satisfies the requirement of this section.

(c) At *New* intersections where on-street parking and bike lanes may be present or where width allows, smaller curb radii or curb extensions to minimize pedestrian exposure and collision severity are present, the effective turning radius shall not be less than fifty (50) feet as illustrated in Figure 3 below.

(d) At *New* intersections without on-street parking and/or bike lanes where speeds approaching the intersection are less than 15 mph; and traffic volumes on the receiving road are less than 120 vehicles per hour during either an evacuation event or during the peak commute hour, whichever is a higher volume, curb radii of twenty (20) feet based on modeling performed by a Professional Engineer, as described within the Professional Engineers Act (Chapter 7 of Division 3 of the Business and Professions Code), that demonstrates Fire Apparatus can negotiate the proposed horizontal inside radius as illustrated in Figure 4, satisfies the requirement of this section.

(e) The length of vertical curves of *New Roads*, exclusive of gutters, ditches, and drainage structures designed to hold or divert water, shall be not less than one hundred (100) feet.

§1273.02. Road and Driveway Surfaces.

(a) *New Roads* and *New* appurtenant driving surfaces that supplement the *New Traffic Lane* shall support the imposed load of Fire Apparatus weighing 75,000 pounds. The surface material of the *New Road* shall be non-erodible (including, but not limited to, a binding agent, gravel, lime slurry, or pavement) and designed to support the required weight at all times, including during saturated soil conditions.

(b) *New Driveways* and ~~and~~ appurtenant driving surfaces that supplement the Driveway shall be designed and maintained to support at least 36,000 pounds.

(c) The Project proponent shall provide certified engineered engineering specifications to support the *New Road* or Driveway design, if requested by the AHJ.

§1273.03. Bridges or Elevated Structures on Roads and Driveways. Grades.

(d) Where **New** elevated structures designed for Fire Apparatus use are adjacent to **Existing** surfaces which are not designed for such use, barriers, signs, and/or other distinguishing features, as approved by the AHJ, shall be installed and maintained.

(e) **New** Bridges or elevated structures with only one Traffic Lane shall be consistent with requirements outlined in § 1273.05 (Road and Driveway Traffic Lane Width and Clear Width).

§1273.06 **New** Road and **New** Driveway Vertical Clearances

New Roads and **New** Driveways shall provide for a minimum of thirteen feet and six inches (13' 6") of unobstructed Vertical Clearance.

§1273.09 Road and Driveway Turnouts

(a) Turnouts on **New Roads** shall be a minimum of twelve (12) feet wide from the shoulder stripe, twenty-two (22) feet long with a minimum twenty-five (25) foot taper on each end and be facilitated outside of the Traffic Lane to accommodate one passenger vehicle as illustrated on Figure 5.

(b) On **New** One-way Roads and Dead-end Roads over 400 feet in length, a Turnout shall be located at approximately the midpoint of the **New** Road, in addition to any other Turnouts Required.

(c) Turnouts shall be provided no more than 400 feet apart on **New** One-way Roads or on **Existing** Roads that do not meet the width requirements.

(d) **New** Driveways that are less than 20 feet wide and exceed 150 feet in length shall require a Turnout.

(e) **New** Driveways greater than 150 feet in length and less than 800 feet in length shall provide a Turnout near the midpoint of the Driveway.

(f) Where the **New** Driveway exceeds 800 feet, Turnouts shall be provided no more than 400 feet apart.

(g) No parking, obstructions, or storage of any material shall be allowed within Turnouts on **New Roads and Driveways**.

§1273.10 **New** Road and **New** Driveway Turnarounds

(a) Each **New** Dead-end Road shall have a Turnaround constructed at its terminus. Where a **New** Dead-end Road crosses parcels zoned for five (5) acres or larger, a Turnaround shall also be provided halfway along the **New** Dead-end Road.

(b) A Turnaround shall be provided on **New** Driveways over 300 feet in length and shall be within fifty (50) feet of the Building.

(c) A Turnaround shall meet all of the following requirements in subsections (d), (e), and (f), and shall be in accordance with Figures 6.1, 6.2, or 6.3.

§1273.11 Gates

(a) Gates shall have an approved means of emergency operation. Electronic gates shall have a manual method of opening in case of electronic failure. The manual method shall be maintained to be operational at all times.

(b) Gate entrances shall be at least two (2) feet wider than the width of the *New Road or New Driveway*, as shown in Figure 7 below. Where a gate is installed across an existing Road or Driveway, the gate shall be no less than ten (10) feet wide, with a minimum Clear Width of fourteen (14) feet and unobstructed Vertical Clearance of thirteen feet, six inches (13' 6"). Clearance shall be maintained at all times.

(c) Where a *New One-way Road* with a single Traffic Lane leads to a gated entrance, a forty (40) foot turning radius shall be provided illustrated on Figure 7.

(d) All gates on a *New Driveway* shall be located at least thirty (30) feet from the *New Road* and shall either slide sideways or open to allow a vehicle to stop without stopping traffic on the Road, in accordance with Figure 7.

- 2B. Eliminate the three criteria from §1273.00(c) and utilize the parcel map standard of up to four parcels and the existing California Environmental Quality Act Exemptions as thresholds for application of “Existing Roads” standards.
- 2C. Add language to §1273.12(a)(1), 14’ width requirement, to allow for a reduction of standards to “allow vehicle to pass each other at reasonable intervals” where natural site constraints would make meeting this standard impossible. Add language to §1273.12(a)(3) to allow for an exception or alternate means of compliance for scenarios where site-specific constraints (such as topography) would make meeting this standard impossible. Add a cross reference to “§1270.06 Exceptions” in §1273.12(a) to make it clear that “Exceptions” are permitted.

§ 1273.12 Standards for Existing Roads

(a) Except as provided in subsections ~~(b) and (c)~~, (d), (e) and (f), Existing Roads that provide Access to New Building Construction along at least one route shall meet the following minimum requirements:

(1) One (1) fourteen (14) foot Traffic Lane. *Where such Traffic Lanes are not possible due to physical site limitations such as localized topography, slope stability or soil conditions, Access shall provide for locations for vehicles to pass each other at reasonable intervals;*

(2) Surfacing which supports the imposed load of Fire Apparatus, subject to the standards set forth in §1273.02. and

(3) Turnouts in compliance with § 1273.09 (Road and Driveway Turnouts), or maintains a twenty (20) foot Clear Width suitable to serve as a Traffic Lane for the length of the Road. *Where such Traffic Lanes are not possible due to physical site limitations such as localized*

topography, slope stability or soil conditions, Access shall provide for locations for vehicles to pass each other at reasonable intervals;

(d) Exceptions may be requested and approved in conformance with § 1270.06 (Exceptions to Standards).

2D. Add a new section to §1270.03 “Scope” exempting scenarios where application of the MFSR standards would result in a taking.

(j) These regulations shall not apply where application of the regulations would result in a taking or damage private property for public use, without the payment of just compensation therefor under the Constitution of the State of California or the United States.²

2E. Add an exemption to §1273.12 “Standards for Existing Roads” related to sensitive environmental areas as suggested in Santa Clara County’s 2021 comment letter.

(f) The standards in this section shall not apply to portions of Existing Roads in sensitive environmental areas (e.g., creeks, streams, oak woodlands, sensitive and protected species habitat areas) or where compliance would require the removal or severe pruning of native trees that have a circumference of 37.7 inches or more (12 inches or more in diameter) measured at 4.5 feet above the ground or immediately below the lowest branch, whichever is lower, or in the case of multi-trunk trees a trunk size of 75.4 inches in circumference or more (24 inches or more in diameter) or where compliance is not Feasible.³

2F. The updated 1273.12(a)(3) language requiring a “twenty-foot Clear Width” does not account for scenarios where this is unreasonable or impossible due to physical site limitations. Use the language in the previous draft specified in 1273.12(b) that was removed from the subsequent December draft in order to allow for an exemption based on site conditions.

(3) Turnouts in compliance with § 1273.09 (Road and Driveway Turnouts), or maintains a twenty (20) foot Clear Width suitable to serve as a Traffic Lane for the length of the Road. Where such Turnouts are not possible due to physical site limitations such as localized topography, slope stability or soil conditions, Access shall provide for vehicles to pass each other at reasonable intervals.

B. Issues with the application of "New Roads" standards to secondary routes for existing roads

§1273.12(c)(1) requires secondary routes to meet the standards for new roads which is counterproductive and detrimental to County and community-based efforts to increase the fire safety of communities with subdivisions and parcels created before modern MFSRs (prior to January 1, 1991). Many of these communities are constrained by several factors, including infrastructure (existing non-compliant roads, driveways, and dead-end roads as well as an

² Aligns with language suggested by RCRC in its 2021 comment letter.

³ Partially aligns with language suggested by RCRC in its 2021 comment letter.

absence of emergency water sources), topographical features, and property ownership limitations (many Mono County communities are surrounded by public lands).

For example, the community of Swall Meadows is a single-access route community with numerous existing non-conforming dead-end roads. The priority hazard identified in the “Town of Mammoth Lakes and Mono County Multi-Jurisdictional Hazard Mitigation Plan” (MJHMP) for this community is wildfire and historically this area has been threatened by numerous wildfires, most recently the 2015 Round Fire which burned 7,000-acres and destroyed 65 structures. Existing topography, hazard conditions, and public land and private property ownership patterns leaves the community of Swall Meadows very few potential alignments for a secondary access route, none of which are ideal. One potential alignment that would substantially increase the safety of this community would create a new, one-way egress road from an existing dead-end road on the lower section of the neighborhood to a point on the main dead-end road closer to the exit point that connects to a through road. The travel time to exit the subdivision would be reduced for residents fleeing from wildfire. However, the MFSR provision as written would prevent the construction of this connector road because it cannot meet the “New Roads” requirements, such as 14’ width.

The Swall Meadows example is just one of five similar single-access scenarios identified in the MJHMP in four communities (Crowley Lake, McGee Creek, June Lake, and Chalfant).⁴ The other communities would similarly be prevented from implementing a feasible secondary egress route to increase fire safety by the “New Roads” standards which are prohibitive due to cost as well as practical environmental and land ownership issues. The County recommends revising the standards to allow for a minimum safe egress-only route for existing communities. The standard as currently written makes “perfect an enemy of the good,” and the priority for the communities described above should be to provide any type of feasible emergency egress. Requiring a secondary route to meet “New Roads” standards, including road width and load capacity for ingress for emergency vehicles, would simply result in no egress at all for these existing at-risk neighborhoods, leaving them subject to evacuation hazards.

Finally, §1273.08(f) has the potential to create undevelopable parcels where a dead-end road is necessary due to landownership patterns (e.g., surrounded by public lands) or other environmental factors and the larger parcel(s) are located beyond the smaller parcel(s). The allowable length of a dead-end road should be based on the cumulative size of all parcels taking access.

Suggested Solutions

⁴ A total of 402 homes are in similar single access scenarios in the HMP. Swall Meadows has 194 residents in 106 homes and 146 structures; the Lakeridge Ranch Estates in Crowley Lake has 32 homes with 35 additional structures; McGee Creek Gregory Lane development has 15 homes and 15 additional structures; the Petersen Tract of June Lake has 140 homes; two Chalfant Communities, White Mountain Estates and West Chalfant Road have 109 homes in total.

2G. Update the language of §1273.12(c)(1) to clarify that only secondary routes associated with new subdivisions and development approvals are required to meet new road standards.

(1) Secondary routes for new subdivisions and new development approvals shall meet the standards for New Roads in this Subchapter and shall provide for legal Access that serves as a typical travel way to and from the Building Construction. A secured secondary route shall meet the requirements in § 1273.11 (Gates).

2H. Add an exemption to §1273.12(c)(1) to allow for existing development constrained by practical limitations (i.e., topography, hazard zones, or property ownership) to construct an “egress only route” with a minimum 10’ width and a load capacity for a standard SUV/van.

(3) Secondary routes for existing developments that are constrained by practical limitations such as, but not limited to, topography, hazard zones, and property ownership, shall prioritize an egress-only route with a minimum width of one 10’ travel lane that will support a standard sport utility vehicle or passenger van.

2I. Modify §1273.08(f) to take into account cumulative size of the parcels taking access from the road.

(f) Where a New Dead-end Road provides access to differing zoned parcel sizes requiring different length limits, the ~~shortest~~ allowable length shall ~~apply~~ be based on the cumulative size of all parcels taking access from this road.

III. Miscellaneous Comments & Suggested Solutions for Articles 1, 2, 4 and 5

A. In order to facilitate clear communication between the BOF and stakeholders about the 2022 MFSR update, all subsequent drafts of the MFSR should include a “draft date” or “version number” in the header of the proposed text and in the file name. The most current draft hasn’t been discernable through this process, especially when the BOF releases updates in close proximity to the previous update.

B. The language in §1270.03(d) that removed “Agriculture” and substituted a new general but not all-encompassing definition of agricultural uses should be changed back to the previous version. The new attempted definition of Agriculture does not account for livestock or animal husbandry uses, which accounted for 49% and \$15,624,000 of Mono County’s total agricultural production in 2020. Alternatively, if the BOF does not want to revert to the previous language, then the existing definition of Agriculture established by the Agricultural Commissioners of the State (that includes livestock and animal husbandry) should be used instead.

*(d) The standards in these regulations applicable to Roads shall not apply to Roads used solely for **Agriculture**; mining; the management of timberland and harvesting of forest products; ~~or the planting, growing, or harvesting of plants (including related activities such as processing, storage, and transportation) for the marketing of the resulting products.~~*

- C. §1275.01(c) Approved Water Supply appears to require water tanks for all new construction and the AHJ is unclear in this section. At a minimum, water tanks should only be required in conjunction with New Residential Units.

(c) All New Building Construction proposals shall include a water supply for structure defense. Such protection shall be serviceable prior to and during the time of construction, except when alternative methods of protection are provided and approved by the AHJ. In this case the AHJ, shall be the entity that issues will serve letters for fire protection services.

Placeholder for Board direction. Does Mono County wish to comment on this requirement? Currently water supply (e.g., water tanks) are only required in Long Valley and Wheeler Crest Fire Protection Districts per Land Use Element General Plan §22.130.A.

- D. Update Figure 5 “Turnout Dimensions” (on Page 46 of January MFSR), the exhibit shows an overall width of 24 feet at the turnout, which is correct for a one-way road, but not correct for a driveway. This exhibit should be revised to only show the additional 12’ required for the turnout, and not show the through lane width, nor show the sometimes incorrect 24’ overall width.
- E. Remove “block” from the language proposed in §1276.01(b)(1), as there are many other alternates to block walls that are non-combustible.

(1) non-combustible ~~block~~ walls or fences; or

IV. Cooperation and Collaboration Between Jurisdictions

This regulatory system is a cooperative effort between the BOF, CAL FIRE staff, and local governments with the common goal of protecting our communities from fire hazards. In the spirit of improving that cooperation, the County raises the following points in the hopes that the BOF will seriously consider the input by Mono County, RCRC, and other local jurisdictions, all of whom are directly affected by the practical consequences of these proposed regulations:

- Leaving unaddressed the presumably unintended consequences and state-level policy conflicts being raised by local jurisdictions is not a good faith effort.
- Rapid and reactionary policymaking in response to recent wildfires that fail to appropriately weigh the costs and implications of those regulatory changes is unwise and results in unintended consequences. Reactionary policy making, as opposed to a deliberative and thoughtful process that incorporates local government comments about practical impacts, is simply poor governance.
- Creating new definitions and standards when existing ones have been adopted and are in use unnecessarily complicates the regulations and hinders successful implementation.
- Mono County staff would be happy to meet with BOF staff. No outreach from BOF staff has been received to date.

- **Suggested Solution:** Consider the input from local jurisdictions and RCRC, make changes where warranted, recognize the practicalities of existing development patterns and environmental constraints, and use existing standards and definitions when possible. Take the time to craft thoughtful policy and regulatory solutions to enhance community fire safety with meaningful input from local jurisdictions.

V. Conclusion

If the intention of the BOF is to implement a productive public process to improve the proposed regulations and result in on-the-ground implementation that considers both the need for enhanced Fire Safe Standards and providing for development, then the BOF has missed the mark. The current draft of the MFSRs hamstring local rural economies even further, creates barriers to housing production within existing rural communities and forces that production to new large-lot subdivisions, and creates conflict with state housing directives. The draft regulations also potentially mandate harmful environmental impacts, create exposure to claims of takings and disproportionate exactions, and impose prohibitive costs of potentially hundreds of thousands to millions of dollars on private landowners (as well as counties and transportation jurisdictions) to support even minor new development. If these are not the intended policy outcomes of the BOF, then these regulations were not yet ready to be released for a 15-day comment period and time should be taken to reconsider and rework them for a revised draft release when the above issues have been appropriately addressed.

The County seeks to reduce fire risk, as does the BOF. However, the proposed regulations appear, at least in part, to use heavy-handed and clumsy regulatory tactics with unintended consequences and outcomes. Refinement of the proposed policies is necessary to ensure a successful regulatory system implemented through state and local cooperation that 1) balances competing priorities and 2) protects lives and reduces losses through good planning that considers the reality of existing constraints and established land use patterns, while allowing for development on private property.

Thank you for your time and consideration of the County's comments. Should you have any questions regarding our comments or wish to discuss our concerns further, please contact Mono County Community Development Director Wendy Sugimura at (760) 924-1814 or wsugimura@mono.ca.gov.

Sincerely,

Supervisor Bob Gardner
Chair, Mono County Board of Supervisors

cc: The Honorable Franklin Bigelow, California State Assembly

The Honorable Andreas Borgeas, California State Senate
Town of Mammoth Lakes
Antelope Valley Fire Protection District
Bridgeport Fire Protection District
Chalfant Valley Fire Department
June Lake Fire Protection District
Lee Vining Fire Protection District
Long Valley Fire Protection District
Mammoth Lakes Fire Protection District
Mono City Fire Protection District
Paradise Fire Protection District
Wheeler Crest Fire Protection District
White Mountain Fire Protection District
Rural County Representatives of California
California State Association of Counties

BOARD OF FORESTRY AND FIRE PROTECTION

P.O. Box 944246
SACRAMENTO, CA 94244-2460
Website: www.bof.fire.ca.gov
(916) 653-8007

**Board of Forestry and Fire Protection****15-DAY NOTICE OF ADDITION OF DOCUMENTS AND INFORMATION TO RULEMAKING
FILE AND MODIFIED TEXT****“State Minimum Fire Safe Regulations, 2021”****Title 14 of the California Code of Regulations (14 CCR),
Division 1.5, Chapter 7, Subchapter 2**

[Notice Published January 3, 2022]

**MODIFICATIONS TO TEXT OF PROPOSED REGULATION AND SUPPLEMENTAL
STATEMENT OF REASONS**

Pursuant to the requirements of Government Code §§ 11346.8 and 11347.1, the Board of Forestry and Fire Protection (Board) is providing notice that documents which the Board has relied upon in adopting the proposed regulations pertaining to the “State Minimum Fire Safe Regulations,” specifically related to modifications of the 45-Day Noticed rule text, have been added to the rulemaking file and are available for public inspection and comment.

The following documents have been added to the rulemaking file:

- Revised 45-Day Rule Text- as revised by the Board at their December 8, 2021 meeting.
- Supplement to the Initial Statement of Reasons.

WRITTEN COMMENT PERIOD

Any person, or authorized representative, may submit written, facsimile, electronic or hand-delivered comments relevant to the proposed regulatory action to the Board. **The written comment period ends on Wednesday, January 19, 2022**, which is over 15 days following the publication of this Notice. The Board will consider only comments received by that time. The Board requests, but does not require, that persons who submit written comments to the Board reference the title of the proposed action in their comments to facilitate review.

Written comments may be submitted by U.S. mail to the following address:

Board of Forestry and Fire Protection
Attn: Edith Hannigan, Executive Officer
P.O. Box 944246
Sacramento, CA 94244-2460

Written comments can also be hand delivered or sent by courier to the contact person listed in this notice at the following address:

Board of Forestry and Fire Protection
Attn: Edith Hannigan, Executive Officer
715 P Street
9th Floor
Sacramento, CA 95814

Written comments may also be delivered via e-mail at the following address:

PublicComments@bof.ca.gov

CONTACT PERSON

Requests for copies of the proposed text of the regulations, the *Supplemental Statement of Reasons*, modified text of the regulations and any questions regarding the substance of the proposed action may be directed to:

State Board of Forestry and Fire Protection
Attn: Edith Hannigan, Executive Officer.
P.O. Box 944246
Sacramento, CA 94244-2460
(916) 653-8007

The designated backup person in the event Ms. Hannigan is not available is Mr. Eric Hedge, Regulations Program Manager for the Board of Forestry and Fire Protection. Mr. Hedge may be contacted at the above address or phone.

AVAILABILITY OF STATEMENT OF REASONS AND TEXT OF PROPOSED REGULATIONS

The Board has prepared a Supplemental Statement of Reasons for the proposed action, entitled "State Minimum Fire Safe Regulations", that provides additional information regarding the clarity and necessity of the amendments to 14 CCR §§ 1270.00 *et. seq.* This Supplemental Statement of Reasons and the Initial Statement of Reasons are available from the contact person on request. If the rule text modifications discussed in this Notice are adopted by the Board as proposed at a future meeting, a Final Statement of Reasons will be made available reflecting the comments and responses received during the written comment period. The Final Statement of Reasons will be available from the contact person(s) named in this notice.

A copy of the express terms of the original proposed action using UNDERLINE to indicate an addition to the California Code of Regulations and ~~STRIKETHROUGH~~ to indicate a deletion is also available from the contact person named in this notice.

The Board will have the entire rulemaking file, including all information considered as a basis for this proposed regulation, available for public inspection and copying throughout the rulemaking process at the following address:

California Department of Forestry and Fire Protection
State Board of Forestry and Fire Protection

New Natural Resources Building
715 P Street
9th Floor
Sacramento, CA 94244
Attention: Edith Hannigan
Tel: (916) 653-8007

All of the above referenced information is also available on the Board's "Proposed Rule Packages" website at: <https://bof.fire.ca.gov/regulations/proposed-rule-packages/>

15-DAY NOTICE RULE TEXT MODIFICATIONS KEY

Proposed modifications to the 45-Day Noticed rule text, published on April 23, 2021 are identified in this 15-Day Notice of Rulemaking as follows:

- Existing CCR Text ----- No underline or strikethrough
- 45-Day Noticed rule text addition (published 04/30/2021) ----- single underline
- 45-Day Noticed rule text deletion (published 04/30/2021) ----- ~~single strikethrough~~
- Deletions of 45-Day Noticed rule text proposed in this 15-Day Notice ----- ~~double strikethrough~~
- Additional rule text proposed in this 15-Day Notice ----- double underline

AVAILABILITY OF CHANGED OR MODIFIED TEXT

After all timely and relevant comments received, the Board may adopt the proposed regulations substantially as described in this notice. If the Board again makes modifications which are sufficiently related to the originally proposed text, it will again make the modified text—with the changes clearly indicated—available to the public for at least 15 days before the Board adopts the regulations as revised.

Notice of the comment period and the full text as modified, will be sent to any person who:

- a) testified at the hearings,
- b) submitted comments during the public comment period, including written and oral comments received at the public hearing, or
- c) requested notification of the availability of such changes from the Board.

Requests for copies of the modified text of the regulations may be directed to the contact person listed in this notice. The Board will accept written comments on the modified regulations for no less than 15 days from the date on which they are made publicly available.

1 Title 14 of the California Code of Regulations (14 CCR),
2 Division 1.5, Chapter 7
3 Subchapter 2, Articles 1-5
4 "DRAFT State Minimum Fire Safe Regulations, 2021"

5
6
7 Subchapter 2. ~~SRA/VHFHSZ~~ State Minimum Fire Safe Regulations

8 Article 1. Administration

9 § 1270.00. Title.

10 These regulations shall be known as the "~~SRA/VHFHSZ—State~~
11 Minimum Fire Safe Regulations," and shall constitute the ~~base~~
12 minimum ~~w~~Wildfire protection standards of the California Board
13 of Forestry and Fire Protection.

14 Note: Authority cited: Section 4290, Public Resources Code.

15 Reference: Sections 4102, 4126, 4127 and 4290, Public Resources
16 Code.

17 § 1270.01. Definitions ~~Purpose~~

18 The following definitions are applicable to this Subchapter.

19 (a) Access: The Roads on a route from a Building to the nearest
20 Collector Road or the Roads on a route from a Building to the
21 nearest Road which is compliant with the standards provided in
22 this Article, whichever is closer.

23 ~~(b) Agriculture: Land used for agricultural purposes as defined~~
24 ~~in a Local Jurisdiction's zoning ordinances.~~

25 (c) Authority Having Jurisdiction (AHJ): the organization,

1 office, or individual responsible for enforcing the applicable
2 requirements of these standards, or for approving equipment,
3 materials, an installation, or a procedure. This includes the
4 local government and local fire authority in their respective
5 roles of development approval process and regulatory
6 enforcement.

7 (~~e~~) Board: California Board of Forestry and Fire Protection.

8 (~~e~~) Building: Any Structure used or intended for supporting or
9 sheltering any use or Occupancy, except those classified as
10 Utility and Miscellaneous Group U.

11 (f) Building Construction: the construction, reconstruction,
12 placement, or erection of any Building; a permit or approval for
13 an increase in the density or intensity of use of land,
14 including, but not limited to, subdivision pursuant to the
15 Subdivision Map Act (commencing with Section 66410 of the
16 Government Code), and any other division of land except where
17 the land division is brought about in connection with the
18 purchase of such land by a public agency for public recreational
19 use.

20 (~~e~~) CAL FIRE: California Department of Forestry and Fire
21 Protection.

22 (~~h~~) Clear Width: A horizontal area free of vegetation, debris,
23 fences, or other materials that may impede traffic flow; this
24 area may include flexible posts or barriers that bend upon
25 vehicular impact and rebound to their original position.

(~~s~~) Collector Road: Roads identified by the AHJ ~~a Local~~

1 ~~Jurisdiction as a major collector, or minor collector, or~~
2 ~~general,~~ collector road pursuant to Title 23, Code of Federal
3 Regulations, § 470.105 and in conformance with the procedures in
4 the US Federal Highway Administration "Highway Functional
5 Classification Concepts, Criteria, and Procedures," 2013
6 Edition, hereby incorporated by reference.

7 (~~h~~j) Dead-end Road: A Road that has only one point of vehicular
8 ingress/egress, including cul-de-sacs and ~~Roads that loop back~~
9 ~~on themselves~~ ~~looped Roads.~~

10 (~~h~~k) Defensible Space: As defined in California Code of
11 Regulations, Title 14, § 1299.02(a).

12 (~~h~~l) Development: As defined in section 66418.1 of the
13 California Government Code.

14 (~~h~~m) Director: Director of the Department of Forestry and Fire
15 Protection or their designee.

16 (~~h~~n) Driveway: A vehicular pathway that serves ~~no more than four~~
17 ~~(4) Residential Units~~ ~~up to two (2) parcels with no more than~~
18 ~~two (2) Residential Units~~ and any number of non-commercial or
19 non-industrial Utility or Miscellaneous Group U Buildings on
20 each parcel. A Driveway shall not serve commercial or industrial
21 uses at any size or scale.

22 (~~h~~o) Exception: An alternative means or method to achieve a
23 specified standard requested by the applicant subject to [§](#)
24 [1270.06 \(Exceptions to Standards\)](#).

25 (~~h~~p) Existing: ~~That which is legally established or legally in~~
~~place at the time of the proposal for Building Construction.~~

1 (~~q~~) Existing Road: A physical Road that is legally established
2 or legally in place at the time of the proposal for Building
3 Construction. ~~constructed and used by vehicles prior to a~~
4 ~~Development proposal.~~ An Existing Road is not one exempt under §
5 1270.03(d) if that Road is part of a Building Construction
6 proposal where it is to be used for purposes other than those
7 specified in § 1270.03(e). A Existing Driveway is not an
8 Existing Road, if that Driveway is part of a Building
9 Construction proposal where the Driveway will serve more than
10 four (4) Residential Units.

11 (r) Finished Grade: The highest point of elevation of the
12 finished surface of the ground, landscaping, vegetation, paving,
13 curb or sidewalk within the area extending in a 5 foot diameter
14 from the center of the fire hydrant.

15 (~~s~~) Fire Apparatus: A vehicle designed to be used under
16 emergency conditions to transport personnel and equipment or to
17 support emergency response, including but not limited to the
18 suppression of fires.

19 (~~p~~) ~~Fire Authority: A fire department, agency, division,~~
20 ~~district, or other governmental body responsible for regulating~~
21 ~~and/or enforcing minimum fire safety standards.~~

22 (~~t~~) Fire Hydrant: A valved connection on a water supply or
23 storage system for the purpose of providing water for fire
24 protection and suppression operations.

25 (~~u~~) Fuel Break: A strategically located area where the volume
and arrangement of vegetation has been managed to limit fire

1 intensity, fire severity, rate of spread, crown fire potential,
2 and/or ember production.

3 (~~eu~~) Greenbelts: Agricultural lands, open space, parks,
4 wildlands, or a combination thereof, as designated by the AHJ
5 Local Jurisdictions, which are in, surround, or near areas
6 subject to these regulations that may function as Fuel Breaks or
7 are adjacent to a city or urbanized area, and where Building
8 Construction is restricted or prohibited Development.

9 (~~ey~~) Greenways: Linear open spaces or corridors that link parks
10 and neighborhoods within a community through natural or manmade
11 trails and paths.

12 (~~ew~~) Hammerhead/T: A road or Driveway that provides a "T"
13 shaped, three-point Turnaround space for Fire Apparatus on a
14 Road or Driveway, being no narrower than the Road or Driveway
15 that serves it.

16 (~~ex~~) Hazardous Land Use: A land use that presents a
17 significantly elevated potential for the ignition, prolonged
18 duration, or increased intensity of a Wildfire due to the
19 presence of flammable materials, liquids, or gasses, or other
20 features that initiate or sustain combustion. Such uses are
21 determined by the AHJ Local Jurisdiction and may include, but
22 are not limited to, power-generation and distribution
23 facilities; wood processing or storage sites; flammable gas or
24 liquids processing or storage sites; or shooting ranges.

25 (~~w~~) Local Jurisdiction: Any county, city/county agency or
department, or any locally authorized district that approves or

1 ~~has the authority to regulate Development.~~

2 (~~#z~~) Local Responsibility Area (LRA): Those areas of land ~~not~~
3 ~~classified by the Board~~ where the financial responsibility of
4 preventing and suppressing Wildfires is that of ~~local agencies~~
5 ~~the state or federal government~~, pursuant to Public Resources
6 Code (PRC) section 4125.

7 (~~yaa~~) Local Road: Roads identified by ~~the AHJ a Local~~
8 ~~Jurisdiction~~ as a local road pursuant to Title 23, Code of
9 Federal Regulations, § 470.105 and in conformance with the
10 procedures in the US Federal Highway Administration "Highway
11 Functional Classification Concepts, Criteria, and Procedures,"
12 2013 Edition, hereby incorporated by reference.

13 (~~#bb~~) Municipal-Type Water System: A system having water pipes
14 servicing Fire Hydrants and designed to furnish, over and above
15 domestic consumption, a minimum of 250 gpm (950 L/min) at 20 psi
16 (138 kPa) residual pressure for a two (2) hour duration.

17 (~~aa~~) New Road: ~~That which is proposed as part of a Building~~
18 ~~Construction proposal that is the subject of consideration~~
19 ~~hereunder, and not legally established nor legally in place at~~
20 ~~the time of the proposal for Building Construction. A~~
21 ~~theoretical Road proposed in a Development application.~~

22 (~~bb~~) Occupancy: The purpose for which a Building, or part
23 thereof, is used or intended to be used.

24 (~~eee~~) One-way Road: A ~~Road that provides a~~ minimum of one
25 Traffic Lane width designed for traffic flow in one direction
only.

1 (~~ee~~ff) Perimeter: The boundary of an individual parcel and/or
2 the boundary of a tentative and final **map** or parcel map,
3 pursuant to Government Code § 66411, within which lies any
4 Building ~~e~~Construction.

5 (**gg**) Repair: The reconstruction, replacement or renewal of any
6 part of an existing Structure for the purpose of its maintenance
7 or to correct damage.

8 (~~ee~~hh) Residential Unit: Any Building or portion thereof which
9 contains living facilities, **including which include** provisions
10 for sleeping, **and can include provisions for** eating, cooking
11 and/or sanitation, for one or more persons. Manufactured homes,
12 mobile homes, and factory-built housing are considered
13 residential units. **Buildings, unless being** sited or installed as
14 an accessory or junior accessory dwelling unit in accordance
15 with [§ 1270.03\(d\) \(Scope - Exemptions - ADUs\)](#) **are not considered**
16 **Residential Units.**

17 (~~ff~~ii) Ridgeline: The line of intersection of two opposing slope
18 aspects running parallel to the long axis of the highest
19 elevation of land; **or an area of higher ground separating two**
20 **adjacent streams or watersheds.**

21 (~~gg~~jj) Road: A public or private vehicular pathway to **more than**
22 **two (2) parcels,** more than four (4) Residential Units, or to any
23 industrial or commercial ~~o~~ccupancy.

24 (~~hh~~) Road or Driveway Structures: **Bridges, culverts, and other**
25 **appurtenant structures which supplement the Traffic Lane or**
Shoulders.

1 (~~ikk~~) Shoulder: A vehicular pathway adjacent to the Traffic
2 Lane.

3 (~~jll~~) State Responsibility Area (SRA): As defined in Public
4 Resources Code sections 4126-4127; and the California Code of
5 Regulations, title 14, division 1.5, chapter 7, article 1,
6 sections 1220-1220.5.

7 (~~kmm~~) Structure: That which is built or constructed, ~~a Building~~
8 ~~of any kind,~~ or any piece of work artificially built up or
9 composed of parts joined together in some definite manner.

10 (~~lnn~~) Substantial Compliance [~~or Substantially Complies~~]:
11 Nearly complete satisfaction of ~~each applicable~~ ~~all~~ material
12 requirements consistent with the purpose of the ~~applicable~~ State
13 Minimum Fire Safe Regulations, ~~including without limitation to~~
14 ~~concurrent Fire Apparatus ingress and civilian evacuation.~~
15 ~~Substantial Compliance may be found~~ even though ~~minor~~
16 ~~noncompliance exists.~~ ~~the formal requirements are not satisfied.~~

17 (~~moo~~) Substantial Evidence: Enough relevant information and
18 reasonable inferences from this information that a fair argument
19 can be made to support a conclusion, in light of the whole
20 record of evidence, even though other conclusions might also be
21 reached. Argument, speculation, unsubstantiated opinion or
22 narrative, or evidence which is clearly erroneous or inaccurate
23 does not constitute substantial evidence. Substantial evidence
24 shall include facts, reasonable assumptions predicated upon
25 facts, and expert opinion supported by facts.

(~~npp~~) Traffic Lane: The portion of a Road or Driveway that

1 provides a single line of vehicle travel.

2 (~~egg~~) Turnaround: ~~A portion of a Road or Driveway, unobstructed~~
3 ~~by parking. An area~~ which allows for a safe opposite change of
4 direction for Fire Apparatus ~~at the end of a Road or Driveway.~~
5 ~~Design of such area may be a hammerhead/T or terminus bulb.~~

6 (~~err~~) Turnout: A widening in a Road or Driveway to allow
7 vehicles to pass.

8 (~~ers~~) Undeveloped Ridgeline: A Ridgeline with no ~~Residential~~
9 ~~Units or commercial or industrial~~ Buildings.

10 (~~ertt~~) Utility and Miscellaneous Group U: A Structure of an
11 accessory character or a miscellaneous Structure not classified
12 in any specific ~~Occupancy~~ permitted, constructed, equipped, and
13 maintained to conform to the requirements of Title 24,
14 California Building Standards Code.

15 (~~esu~~) Vertical Clearance: The minimum specified height of a
16 bridge, overhead projection, or vegetation clearance above the
17 Road or Driveway.

18 (~~vv~~) Vertical Curve: A curve at a high or low point of a roadway
19 that provides a gradual transition between two roadway grades or
20 slopes.

21 (~~txx~~) Very High Fire Hazard Severity Zone (VHFHSZ): As defined
22 in Government Code section 51177(i).

23 (~~uyy~~) Wildfire: ~~Has the same meaning as "forest fire" in Public~~
24 ~~Resources Code Section 4103. As defined in Public Resources Code~~
25 ~~Section 4103 and 4104.~~

(a) These regulations have been prepared and adopted for the

1 ~~purpose of establishing minimum wildfire protection standards in~~
2 ~~conjunction with building, construction and development in the~~
3 ~~State Responsibility Area (SRA) and, after July 1, 2021, the Very~~
4 ~~High Fire Hazard Severity Zones as defined in Government Code §~~
5 ~~51177(i) (VHFHSZ).~~

6 ~~(b) The future design and construction of structures,~~
7 ~~subdivisions and developments in the SRA and, after July 1,~~
8 ~~2021, the VHFHSZ shall provide for basic emergency access and~~
9 ~~perimeter wildfire protection measures as specified in the~~
10 ~~following articles.~~

11 ~~(c) These measures shall provide for emergency access; signing~~
12 ~~and building numbering; private water supply reserves for~~
13 ~~emergency fire use; and vegetation modification. The fire~~
14 ~~protection standards which follow shall specify the minimums for~~
15 ~~such measures.~~

16 Note: Authority cited: Section 4290, Public Resources Code.

17 Reference: Sections 4290 and 4291, Public Resources Code.

18
19 § 1270.02. Purpose. ~~Scope~~

20 (a) These regulations have been prepared and adopted for the
21 purpose of establishing state minimum Wildfire protection
22 standards in conjunction with Building ~~e~~Construction ~~and~~
23 ~~Development~~ in the State Responsibility Area (SRA) and, after
24 July 1, 2021, the Very High Fire Hazard Severity Zones, as
25 defined in Government Code § 51177(i) (VHFHSZ).

(b) Building ~~e~~Construction in the SRA ~~approved after January 1,~~

1 ~~1991, and, after July 1, 2021,~~ Building Construction in the
2 VHFHSZ approved after July 1, 2021 shall provide for minimum
3 Wildfire protection standards as specified in the following
4 articles.

5 (c) These standards shall provide for emergency ingress and
6 egress; signing and Building numbering; ~~municipal-type, private,~~
7 ~~and public~~ water supply ~~reserves~~ for emergency fire use;
8 vegetation modification, Fuel Breaks, Greenbelts, and measures
9 to preserve Undeveloped Ridgelines. The regulations which follow
10 shall specify the minimums for such standards.

11 (d) ~~By limiting Building construction in those areas where~~
12 ~~Prescribing~~ these minimum Wildfire protection standards ~~are not~~
13 ~~satisfied, this~~ reduces the risk of Wildfires ~~in these areas,~~
14 which among other things protects the health, safety and welfare
15 of residents, and protects natural resources and the
16 environment.

17 (a) ~~These regulations shall apply to:~~

18 (1) ~~the perimeters and access to all residential, commercial,~~
19 ~~and industrial building construction within the SRA approved~~
20 ~~after January 1, 1991, and those approved after July 1, 2021~~
21 ~~within the VHFHSZ, except as set forth below in subsections (b)~~
22 ~~through (d), inclusive, and (f);~~

23 (2) ~~the siting of newly installed commercial modulars,~~
24 ~~manufactured homes, mobilehomes, and factory built housing, as~~
25 ~~defined in Health and Safety Code sections 18001.8, 18007,~~
~~18008, and 19971, except where being sited or installed as an~~

1 ~~accessory or junior accessory dwelling unit as set forth in~~
2 ~~subsection (d) below;~~

3 ~~(3) all tentative and parcel maps or other developments approved~~
4 ~~after January 1, 1991; and~~

5 ~~(4) applications for Building permits on a parcel approved in a~~
6 ~~pre-1991 parcel or tentative map to the extent that conditions~~
7 ~~relating to the perimeters and access to the Buildings were not~~
8 ~~imposed as part of the approval of the parcel or tentative map.~~

9 ~~(b) These regulations do not apply where an application for a~~
10 ~~Building permit is filed after January 1, 1991 for Building~~
11 ~~construction on a parcel that was formed from a parcel map or~~
12 ~~tentative map (if the final map for the tentative map is~~
13 ~~approved within the time prescribed by the local ordinance)~~
14 ~~approved prior to January 1, 1991, to the extent that conditions~~
15 ~~relating to the perimeters and access to the Buildings were~~
16 ~~imposed by the parcel map or final tentative map approved prior~~
17 ~~to January 1, 1991.~~

18 ~~(c) (1) At the discretion of the Local Jurisdiction, and subject~~
19 ~~to any requirements imposed by the Local Jurisdiction to ensure~~
20 ~~reasonable ingress, egress, and capacity for evacuation and~~
21 ~~emergency response during a Wildfire, these regulations shall~~
22 ~~not apply to the reconstruction or repair of legally constructed~~
23 ~~residential, commercial, or industrial Buildings due to a~~
24 ~~Wildfire, to the extent that the reconstruction or repair does~~
25 ~~not:~~

~~(A) increase the square footage of the residential, commercial,~~

1 ~~or industrial Building or Buildings that previously existed; or~~

2 ~~(B) change the use of the Building or Buildings that had existed~~
3 ~~previously; or~~

4 ~~(C) construct a new Building or Buildings that did not~~
5 ~~previously exist on the site.~~

6 ~~(2) Nothing in this subsection shall be construed to alter the~~
7 ~~extent to which these regulations apply to the reconstruction or~~
8 ~~repair of a legally constructed residential, commercial, or~~
9 ~~industrial Building for reasons unrelated to a Wildfire.~~

10 ~~(d) These regulations do not apply to the creation of accessory~~
11 ~~or junior accessory dwelling units that comply with Government~~
12 ~~Code sections 65852.2 or 65852.22, or any local ordinances~~
13 ~~enacted thereunder, as applicable, including any local~~
14 ~~ordinances requiring provisions for fire and life safety.~~

15 ~~(e) Unless otherwise exempt pursuant to this Subchapter,~~
16 ~~affected activities include, but are not limited to:~~

17 ~~(1) permitting or approval of new parcels, excluding lot line~~
18 ~~adjustments as specified in Government Code (GC) section~~
19 ~~66412(d);~~

20 ~~(2) application for a Building permit for new Building~~
21 ~~construction;~~

22 ~~(3) application for a use permit; and~~

23 ~~(4) road construction.~~

24 ~~(f) EXEMPTION: Roads used solely for agricultural, mining, or~~
25 ~~the management and harvesting of wood products.~~

Note: Authority cited: Section 4290, Public Resources Code.

1 Reference: Sections 4290 and 4291, Public Resources Code.

2
3 § 1270.03. Scope. Provisions for Application of The Regulations

4 (a) These regulations shall apply to:

5 (1) the Perimeters and Access to all residential,
6 commercial, and industrial Building eConstruction within the SRA
7 approved after January 1, 1991, and those approved after July 1,
8 2021 within the VHFHSZ, except as set forth below in subsections
9 (b), (c), (d), and (e) below.

10 (2) the siting or installation of newly installed
11 commercial modulars, manufactured homes, mobilehomes, and
12 factory-built housing, as defined in Health and Safety Code
13 sections 18001.8, 18007, 18008, and 19971, except where being
14 sited or installed as an accessory or junior accessory dwelling
15 unit as set forth in subsection (d) below;

16 ~~(3) all tentative and parcel maps or other Developments~~
17 ~~approved after January 1, 1991; and~~

18 (43) applications for Building permits on a parcel approved
19 in a pre-1991 parcel or tentative map to the extent that
20 conditions relating to the Perimeters and Access to the
21 Buildings were not imposed as part of the approval of the parcel
22 or tentative map.

23 (b) These regulations do not apply where an application for a
24 Building permit in the SRA is filed after January 1, 1991 for
25 Building eConstruction on a parcel that was formed from a parcel
map or tentative map approved prior to January 1, 1991 (if the

1 final map for the tentative map is approved within the time
2 prescribed by the local ordinance). ~~approved prior to January 1,~~
3 ~~1991, to the extent that conditions relating to the Perimeters~~
4 ~~and Access to the Buildings were imposed by the parcel map or~~
5 ~~final tentative map approved prior to January 1, 1991.~~

6 ~~(1) For~~ ~~€~~This exemption shall apply only to the extent
7 that ~~to apply,~~ the parcel map or tentative map that was approved
8 prior to January 1, 1991, ~~shall have~~ imposed conditions relating
9 to the Perimeters and Access to the Building ~~€~~Construction that
10 is the subject of the Building permit application filed after
11 January 1, 1991.

12 ~~(2) These regulations shall apply to the Building~~
13 ~~construction to the extent that conditions relating to the~~
14 ~~Perimeters and Access to the Buildings were not imposed as part~~
15 ~~of the approval of the parcel map or tentative map.~~

16 ~~(c) At the discretion of the Local Jurisdiction, and subject to~~
17 ~~any requirements imposed by the Local Jurisdiction to ensure~~
18 ~~reasonable ingress, egress, and capacity for evacuation and~~
19 ~~emergency response during a Wildfire, these regulations shall~~
20 ~~not apply to the reconstruction or repair of a Building due to a~~
21 ~~Wildfire, subject to the following:~~

22 ~~(1) this exemption shall not apply if the reconstruction or~~
23 ~~repair encroaches on the minimum setback requirements in §~~
24 ~~1276.01 Building and Parcel Siting and Setbacks;~~

25 ~~(2) this exemption shall not apply if the reconstruction or~~
~~repair changes the use of the Building or Buildings that had~~

1 ~~existed previously;~~

2 ~~(3) nothing in this subsection shall be construed to alter~~
3 ~~the extent to which these regulations apply to the~~
4 ~~reconstruction or repair of a Building for reasons unrelated to~~
5 ~~a Wildfire; and~~

6 ~~(4) nothing in this subsection shall be construed to alter~~
7 ~~the legal character of a Building reconstructed or repaired~~
8 ~~pursuant to this exemption.~~

9 (c) These regulations do not apply to the creation of accessory
10 or junior accessory dwelling units that comply with Government
11 Code sections 65852.2 or 65852.22, or any local ordinances
12 enacted thereunder, as applicable, including any local
13 ordinances requiring provisions for fire and life safety.

14 (e) ~~These regulations~~ The standards in these regulations
15 applicable to Roads shall not apply to Roads used solely for
16 Agriculture, mining; ~~or~~ the management of timberland and
17 harvesting of forest products; or the planting, growing, or
18 harvesting of plants (including related activities such as
19 processing, storage, and transportation) for the marketing of
20 the resulting products.

21 (e) The applicable AHJ which approves or adopts construction
22 development permits or maps shall provide the Director of the
23 California Department of Forestry and Fire Protection (CAL FIRE)
24 or their designee with notice of applications for Building
25 permits, tentative parcel maps, tentative maps, and installation
or use permits for construction or development within the SRA or

1 ~~the VHFMSZ.~~

2 (f) The Director or their designee may review and make fire
3 protection recommendations on applicable construction or
4 development permits or maps provided by the local jurisdiction.

5 (g) This Subchapter shall not apply retroactively. The
6 requirements of this Subchapter shall apply when an approval or
7 adoption is sought for Building permits, tentative parcel maps,
8 tentative maps, and installation or use permits for construction
9 or development within the scope of this Subchapter.

10 (h) The AHJ identified in subsection (e) shall not approve or
11 adopt any applicable construction or development permit or map
12 unless an inspection has been made in accordance with this
13 Subchapter and it has been determined that the applicable
14 sections of this Subchapter are satisfied.

15 (i) Activities within the scope of this Subchapter shall be
16 subject to the regulations in effect at the time of the the
17 activity's approval.

18 ~~This Subchapter shall be applied as follows:~~

19 (a) ~~the Local Jurisdictions shall provide the Director of~~
20 ~~the California Department of Forestry and Fire Protection (CAL~~
21 ~~FIRE) or their designee with notice of applications for Building~~
22 ~~permits, tentative parcel maps, tentative maps, and installation~~
23 ~~or use permits for construction or development within the SRA.~~

24 (b) ~~the Director or their designee may review and make fire~~
25 ~~protection recommendations on applicable construction or~~
~~development permits or maps provided by the Local Jurisdiction.~~

1 ~~(c) the Local Jurisdiction shall ensure that the applicable~~
2 ~~sections of this Subchapter become a condition of approval of~~
3 ~~any applicable construction or development permit or map.~~

4 Note: Authority cited: Section 4290, Public Resources Code.
5 Reference: Sections 4290 and 4291, Public Resources Code.

6
7 § 1270.04. Local Regulations Ordinances.

8 (a) These regulations shall serve as the minimum Wildfire
9 protection standards applied in SRA and VHFHSZ. However, these
10 regulations do not supersede local regulations which equal or
11 exceed the standards of this Subchapter. ~~Nothing contained in~~
12 ~~these regulations shall be considered as abrogating the~~
13 ~~provisions of any ordinance, rule or regulation of any state or~~
14 ~~Local Jurisdiction provided that such ordinance, rule, or~~
15 ~~regulation is equal to or exceeds these minimum standards.~~

16 (b) A local regulation equals or exceeds a minimum standard of
17 this Subchapter only if, at a minimum, the local regulation also
18 fully complies with the corresponding minimum standard in this
19 Subchapter. ~~Counties may submit their local ordinances for~~
20 ~~certification via email to the Board, and the Board may certify~~
21 ~~them as equaling or exceeding these regulations when they~~
22 ~~provide the same practical effect. If the Board determines that~~
23 ~~the local requirements do not equal or exceed these regulations,~~
24 ~~it shall not certify the local ordinance.~~

25 (c) A Local Jurisdiction shall not apply exemptions **to these**
regulations that are not enumerated in this Subchapter.

1 Exceptions requested and approved in conformance with [§ 1270.06](#)
2 ([Exceptions to Standards](#)) may be granted on a case-by-case
3 basis. ~~When the Board grants certification, the local~~
4 ~~ordinances, in lieu of these regulations, shall be applied as~~
5 ~~described in 14 CCR § 1270.02 and used as the basis for~~
6 ~~inspections performed under 14 CCR § 1270.05.~~

7 ~~(d) A Local Jurisdiction or Fire Authority may notify the Board~~
8 ~~upon commencement of any revisions to relevant local~~
9 ~~regulations. The Board may provide technical assistance to the~~
10 ~~agency during the revision drafting process.~~ The Board's
11 certification of local ordinances pursuant to this section is
12 rendered invalid when previously certified ordinances are
13 subsequently amended by Local Jurisdictions, or the regulations
14 are amended by the Board, without Board re-certification of the
15 amended ordinances. The Board's regulations supersede the
16 amended local ordinance(s) when the amended local ordinance(s)
17 are not re-certified by the Board. Amendments made by Local
18 Jurisdictions to previously certified ordinances shall be
19 submitted for re-certification.

20 ~~(e) The Local Jurisdiction or Fire Authority may submit their~~
21 ~~draft regulation to the Board at least 90 days before the first~~
22 ~~meeting of the Local Jurisdiction or Fire Authority at which the~~
23 ~~proposed draft will be presented to the public.~~

24 ~~(f) The Board may provide recommendations on the draft within 60~~
25 ~~days.~~

(e~~d~~) Notwithstanding a local regulation that equals or exceeds

1 the State Minimum Fire Safe Regulations, Building ~~e~~Construction
2 shall comply with the State Minimum Fire Safe Regulations.

3 Note: Authority cited: Section 4290, Public Resources Code.

4 Reference: Sections 4290 and 4291, Public Resources Code.

5
6 § 1270.05. Inspections.

7 Inspections shall conform to the following requirements:

8 (a) Inspections in the SRA shall be made by the AHJ, which may
9 be:

10 (1) the Director, or

11 (2) A local agency ~~Local Jurisdictions~~ that has~~ve~~ assumed
12 state fire protection responsibility on SRA lands, or

13 (3) A local agency ~~Local Jurisdictions~~ where the inspection
14 duties have been formally delegated by ~~CAL FIRE~~ the Director to
15 the local agency ~~Local Jurisdiction~~, pursuant to subsection (b).

16 (b) The Director may delegate inspection authority to a local
17 agency ~~Local Jurisdiction~~ subject to all of the following
18 criteria:

19 (1) The agency ~~Local Jurisdiction~~ represents that they have
20 appropriate resources to perform the delegated inspection
21 authority.

22 (2) The agency ~~Local Jurisdiction~~ acknowledges that CAL
23 FIRE's authority under subsection (d) shall not be waived or
24 restricted.

25 (3) The agency ~~Local Jurisdiction~~ consents to the
delegation of inspection authority.

1 (4) The Director may revoke the delegation at any time.

2 (5) The delegation of inspection authority, and any
3 subsequent revocation of the delegation, shall be documented in
4 writing, and retained on file at the CAL FIRE Unit headquarters
5 that administers SRA fire protection in the **area. Local**
6 **Jurisdiction.**

7 ~~Nothing in this section abrogates CAL FIRE's authority to~~
8 ~~inspect and enforce state forest and fire laws even when the~~
9 ~~inspection duties have been delegated pursuant to this section.~~

10 (c) Inspections in the VHFHSZ shall be made by the **appropriate**
11 **local AHJ Local Jurisdiction or Fire Authority.** ~~Reports of~~
12 ~~violations shall be provided to the CAL FIRE Unit headquarters~~
13 ~~that administers SRA fire protection in the Local Jurisdiction.~~

14 (d) ~~Nothing in this section abrogates CAL FIRE's authority to~~
15 ~~inspect and enforce state forest and fire laws in the SRA even~~
16 ~~when the inspection duties have been delegated pursuant to this~~
17 ~~section. When inspections are conducted, they shall occur prior~~
18 ~~to: the issuance of the use permit or certificate of occupancy;~~
19 ~~the recordation of the parcel map or final map; the filing of a~~
20 ~~notice of completion; or the final inspection of any project or~~
21 ~~Building permit.~~

22 (e) Reports of violations within the SRA shall be provided to
23 the CAL FIRE Unit headquarters that administers SRA fire
24 protection in the Local Jurisdiction.

25 (f) Inspections conducted by the Director shall be limited to
confirming compliance with the State Minimum Fire Safe

1 Regulations. ~~Inspections conducted by~~ The local AHJ ~~the Local~~
2 ~~Jurisdiction or Fire Authority~~ shall confirm compliance with the
3 State Minimum Fire Safe Regulations and may ~~. A Local~~
4 ~~Jurisdiction may,~~ in its discretion, conduct additional
5 inspections with respect to a local regulation that equals or
6 exceeds the State Minimum Fire Safe Regulations.

7 (g) The AHJ ~~Local Jurisdiction~~ shall ensure that any applicable
8 Building ~~Ce~~onstruction complies with the applicable sections of
9 this Subchapter.

10 Note: Authority cited: Section 4290, Public Resources Code.
11 Reference: Sections 4102, 4119, 4125, 4290 and 4291, Public
12 Resources Code.

13 § 1270.06. Exceptions to Standards.

14 (a) The requirements in this section apply to requests for
15 Exceptions from the standards in the State Minimum Fire Safe
16 Regulations.

17 (ba) Upon request by the applicant, and at the discretion of the
18 AHJ, an ~~e~~Exceptions to a standards within this ~~s~~Subchapter ~~or to~~
19 ~~Local Jurisdiction certified ordinances may be~~ considered
20 granted allowed by the AHJ inspection entity in accordance with
21 listed in § 1270.05 (Inspections). ~~where the exceptions provide~~
22 ~~the same practical effect as these regulations towards providing~~
23 ~~defensible space.~~

24 (1) Exceptions shall only be granted where the Exception
25 provides for Substantial Compliance with the minimum standards

1 provided in this Subchapter.

2 (2) Decisions on Exceptions considered granted by the AHJ
3 inspection entity listed in 14 CCR § 1270.05, whether granted
4 or denied, shall be made on a case-by-case basis only, shall be
5 in writing, and shall be supported by Substantial Evidence.
6 Decisions ~~Exceptions granted~~ by the AHJ inspection entity listed
7 in 14 CCR § 1270.05 and all relevant documentation shall be
8 forwarded to the ~~Board and the~~ appropriate CAL FIRE unit
9 headquarters Unit Office that administers SRA fire protection in
10 that ~~Local Jurisdiction, or the county in which the Local~~
11 ~~Jurisdiction is located~~ county. Decisions and all relevant
12 documentation ~~Exceptions~~ shall be retained on file ~~at both~~
13 ~~offices~~ for a period of no less than five (5) years. ~~and shall~~
14 ~~be retained on file at the Unit Office.~~

15 (bc) Requests for an eException shall be made in writing to the
16 AHJ inspection entity listed in 14 CCR § 1270.05 by the
17 applicant or the applicant's authorized representative.

18 (1) At a minimum, the Exception requests shall state

19 (~~ii~~A) the specific section(s) for which an eException is
20 requested;

21 (~~ii~~B) material facts supporting the necessity for an
22 Exception ~~contention of the applicant;~~

23 (~~ii~~C) material facts demonstrating the proposed
24 alternative mean(s) Substantially Complies with the State
25 Minimum Fire Safe Regulation for which the Exception is
requested; the details of the exception proposed, and

1 ~~(D)~~ a map showing the proposed location and siting
2 of the eException, including address or parcel number, as
3 applicable; and =

4 (E) any other information deemed relevant by the
5 applicant or applicant's representative.

6 (2) AHJs ~~Local Jurisdictions~~ acting as inspection entities
7 pursuant to ~~listed in~~ § 1270.05 (Inspections) may establish
8 additional procedures or requirements for eException
9 requests.

10 ~~(ed) Where an exception is not granted by the inspection entity,~~
11 ~~the applicant may appeal such denial to the Local Jurisdiction.~~

12 The decision by an AHJ not to consider an Exception request may
13 not be appealed. Decisions on Exception requests considered by
14 the AHJ, whether granted or denied, ~~decisions~~ may be appealed to
15 the local governmental body with jurisdiction over the AHJ,
16 which ~~The Local Jurisdiction~~ may establish or utilize an appeal
17 process consistent with existing local Building or planning
18 department appeal processes.

19 (1) In addition to local requirements, the governmental
20 body hearing the appeal ~~Local Jurisdiction~~ shall consult with
21 the ~~inspector inspection entity~~ prior to making a determination
22 on an appeal.

23 (2) The inspector ~~inspection entity~~ shall provide
24 documentation demonstrating how the requested Exception does or
25 does not ~~s~~Substantially ~~e~~Comply with the standards in this
Subchapter. ~~Before the Local Jurisdiction makes a determination~~

1 ~~on an appeal, the inspection authority shall be consulted and~~
2 ~~shall provide to that Local Jurisdiction documentation outlining~~
3 ~~the effects of the requested exception on Wildfire protection.~~

4 (e) Where there is an appeal, ~~If an appeal is granted,~~ the AHJ
5 ~~Local Jurisdiction~~ governmental body hearing the appeal shall
6 make written findings of the Exception's Substantial Compliance,
7 as defined § 1270.01 (Definitions), with the minimum standards
8 in this Subchapter, supported by Substantial Evidence. ~~that the~~
9 ~~decision meets the intent of providing defensible space~~
10 ~~consistent with these regulations.~~ Such findings shall include a
11 written statement of reasons for reversing ~~overriding~~ the
12 decision of the inspector ~~inspection entity,~~ if necessary
13 applicable. A ~~written~~ copy of the written ~~these~~ findings shall
14 be provided to the Board and the CAL FIRE Unit headquarters
15 that administers SRA fire protection in that area. ~~Local~~
16 ~~Jurisdiction, or in the county in which the Local Jurisdiction~~
17 is located.

18 Note: Authority cited: Section 4290, Public Resources Code.
19 Reference: Sections 4290 and 4291, Public Resources Code.

20 § 1270.07. Distance Measurements.

21 All specified or referenced distances are measured along the
22 ground, unless otherwise stated.

23 Note: Authority cited: Section 4290, Public Resources Code.
24 Reference: Sections 4290 and 4291, Public Resources Code.

1 § 1270.08. Reconstruction and Repair After a Wildfire

2 (a) At the discretion of the AHJ, and subject to any
3 requirements imposed by the AHJ to ensure reasonable ingress,
4 egress, and capacity for evacuation and emergency response
5 during a Wildfire, these regulations shall not apply to the
6 reconstruction or Repair of a Building due to a Wildfire,
7 subject to the following:

8 (1) the reconstruction or repair shall not encroach on the
9 minimum setback requirements in § 1276.01 Building and Parcel
10 Siting and Setbacks;

11 (2) the reconstruction or repair shall not change the use
12 of the Building or Buildings that had existed previously;

13 (3) nothing in this subsection shall be construed to alter
14 the extent to which these regulations apply to the
15 reconstruction or repair of a Building for reasons unrelated to
16 a Wildfire; and

17 (4) nothing in this subsection shall be construed to alter
18 the legal character of a Building reconstructed or repaired
19 pursuant to this exemption.

20 (b) Access to Buildings being reconstructed or Repaired after a
21 Wildfire shall provide for at least one (1) fourteen (14) foot
22 Traffic Lane for a distance of at least twenty-two (22) feet at
23 an interval of at least every 400 feet; provided, however, where
24 such Traffic Lanes are not possible due to physical site
25 limitations such as localized topography, slope stability or
soil conditions, Access shall provide for locations for vehicles

1 to pass each other, or for one vehicle to pull off the Road so
2 the another may pass, at reasonable intervals.

3 Note: Authority cited: Section 4290, Public Resources Code.

4 Reference: Sections 4290 and 4291, Public Resources Code.

5
6 Article 2. ~~Emergency Access~~ Ingress and Egress

7 § 1273.00. Purpose and Application ~~Intent.~~

8 (a) Access to Building Construction shall provide for concurrent
9 Fire Apparatus ingress and civilian evacuation, and shall
10 provide unobstructed traffic circulation during a Wildfire, as
11 set forth in this Article. ~~New Roads, and dDriveways, and Road~~
12 ~~or Driveway Structures, whether public or private, unless~~
13 ~~exempted under § 1270.03(b) (e) (Scope Exemptions) 14 CCR~~
14 ~~1270.02(c), shall provide for concurrent Fire Apparatus ingress~~
15 ~~and safe access for emergency wildfire equipment and civilian~~
16 ~~evacuation concurrently, and shall provide unobstructed traffic~~
17 ~~circulation during a Wwildfire emergency consistent with 14 CCR~~
18 ~~§§ 1273.00 through 1273.09, as set forth in this Article.~~

19 (b) The provisions of this Article and Article 3 (Signing and
20 Building Numbering) shall apply to all New Roads, New Driveways,
21 New elevated surface, or New appurtenant surfaces. New Roads,
22 Driveways, or Road or Driveway Structures,

23 ~~(c) the provisions of this Article and Article 3 (Signing and~~
24 ~~Building Numbering) shall further apply to all Existing Roads,~~
25 ~~Driveways, or Road or Driveway Structures within a Perimeter.~~

(c) The provisions of this Article and Article 3 (Signing and

1 Building Numbering) shall ~~further~~ apply to any Existing Road,
2 Existing Driveway, Existing elevated surface, or Existing
3 appurtenant surfaces, as described in these regulations, Road or
4 Driveway Structure that provides Access to the following types
5 of Building Construction in the SRA high or very high fire
6 hazard severity zones, as specified in 14 CCR § 1280.01, or
7 VHFHSZ: which includes

8 (1) the permitting or approval of three (3) or more ~~new~~
9 parcels, excluding lot line adjustments as specified in
10 Government Code (GC) section 66412(d); or

11 (2) an application for a change of zoning which proposes to
12 increase zoning intensity or density; or

13 (3) an application for a change in use permit which
14 proposes to increase use intensity or density.

15 ~~(d) Notwithstanding any other provision in this Subchapter,~~
16 ~~Building construction is prohibited where Access is provided by~~
17 ~~a Road that does not meet the minimum requirements in § 1273.12~~
18 ~~(Standards for Existing Roads).~~

19 Note: Authority cited: Section 4290, Public Resources Code.

20 Reference: Sections 4290 and 4291, Public Resources Code.

21 § 1273.01. Horizontal and Vertical Curves / Curb Radii at
22 Intersectionswidth.

23 (a) No Road or appurtenant surface ~~Road Structure~~ shall have a
24 horizontal inside radius of curvature (measured from the
25 centerline of the inside lane) of less than fifty (50) feet,

1 except as provided for in subsections (b), (c), and (d).

2 (1) An additional four (4) feet of surface width shall be
3 added to the required widths in § 1273.05 (Road and Driveway
4 Traffic Lane Width and Clear Width) to curves of 50-100 feet
5 radius.

6 (2) One (1) foot of additional Road width shall be added to
7 curves of 100-200 feet, as illustrated on Figure 1 and Figure 2.

8 (3) Flexible posts may be placed within the required
9 radius.

10 (b) Where the operating speed of a Road is 15 miles per hour
11 (mph) or less, an alternative standard to subsection (a) based
12 on modeling performed by a Professional Engineer, as described
13 within the Professional Engineers Act (Chapter 7 of Division 3
14 of the Business and Professions Code), that demonstrates Fire
15 Apparatus can negotiate the proposed horizontal inside radius
16 satisfies the requirement of this section.

17 (c) At intersections where on-street parking and bike lanes may
18 be present or where width allows, smaller curb radii or curb
19 extensions to minimize pedestrian exposure and collision
20 severity are present, the effective turning radius shall not be
21 less than fifty (50) feet as illustrated in Figure 3 below.

22 (d) At intersections ~~in areas~~ without on-street parking and/or
23 bike lanes where speeds approaching the intersection are less
24 than 15 mph; and traffic volumes on the receiving road are less
25 than 120 vehicles per hour during either an evacuation event or
during the peak commute hour, whichever is a higher volume, curb

1 radii of twenty (20) feet based on modeling performed by a
2 Professional Engineer, as described within the Professional
3 Engineers Act (Chapter 7 of Division 3 of the Business and
4 Professions Code), that demonstrates Fire Apparatus can
5 negotiate the proposed horizontal inside radius as illustrated
6 in Figure 4, satisfies the requirement of this section.

7 (e) The length of vertical curves of ~~the~~ Roads, exclusive of
8 gutters, ditches, and drainage structures designed to hold or
9 divert water, shall be not less than one hundred (100) feet.

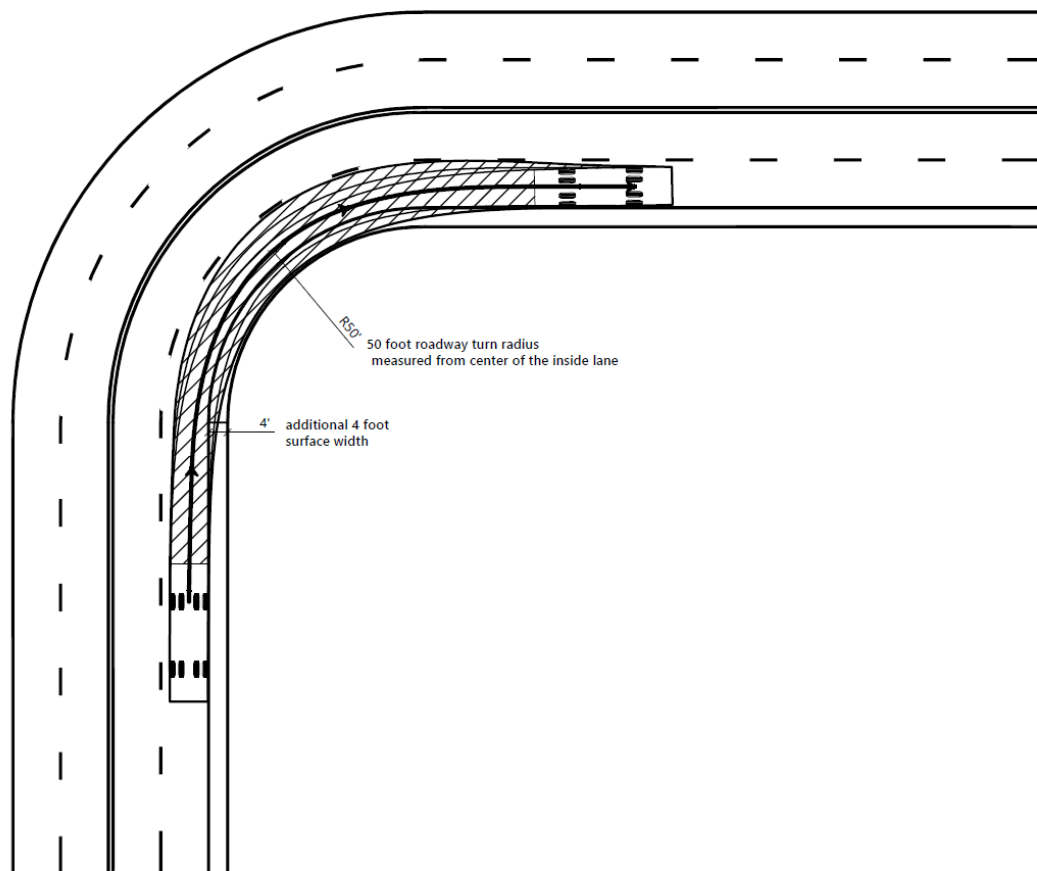

1
2
3
4
5
6
7
8
9
10
11
12
13
14
15
16
17
18
19
20
21
22
23
24
25

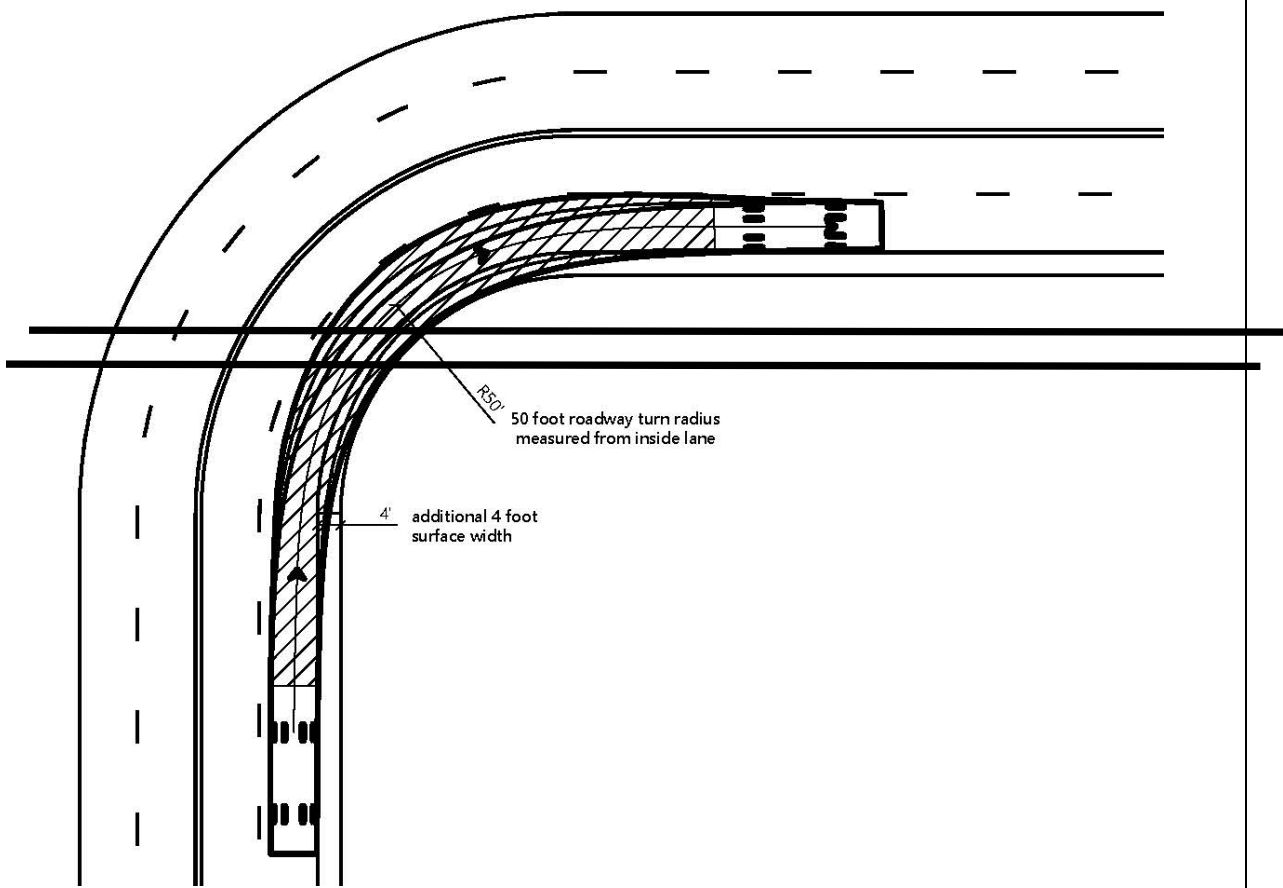

Figure 1
Effective Turning Radius for Horizontal Curvature with 50 Foot Radius

1
2
3
4
5
6
7
8
9
10
11
12
13
14
15
16
17
18
19
20
21
22
23
24
25

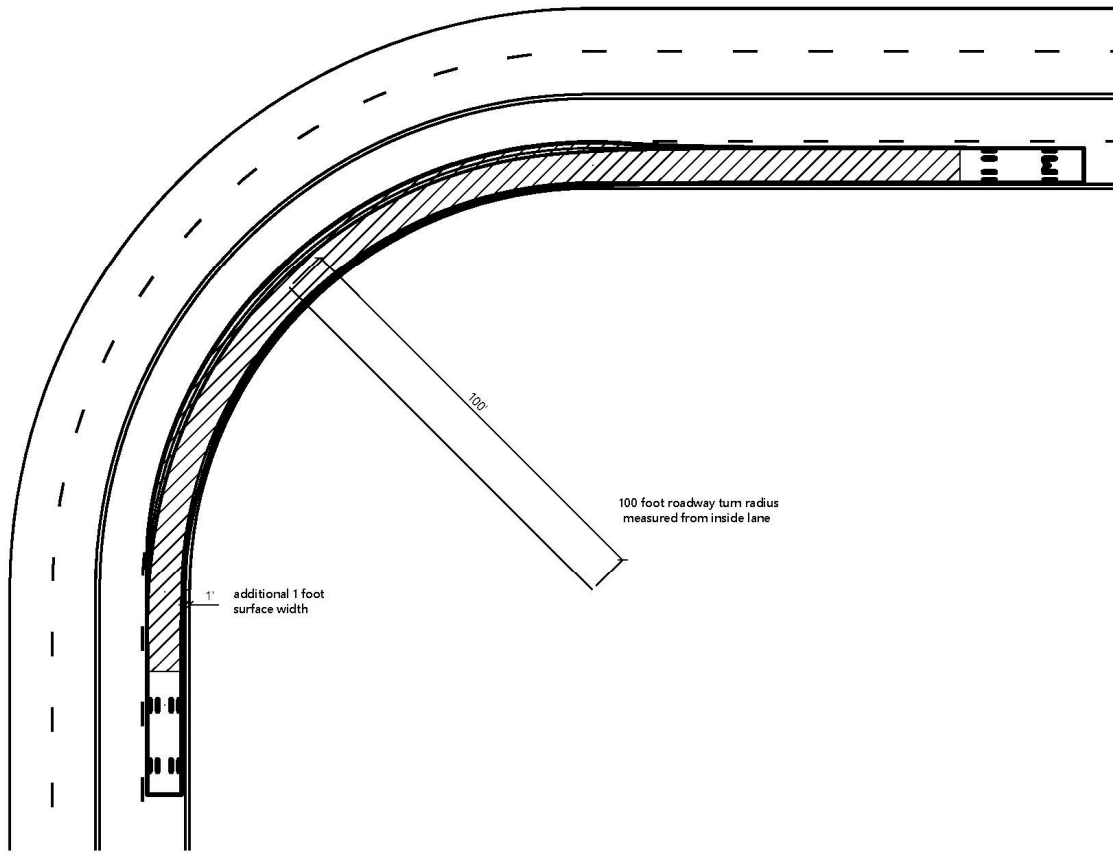

Figure 2
Effective Turning Radius for Horizontal Curvature with 100 Foot Radius

1
2
3
4
5
6
7
8
9
10
11
12
13
14
15
16
17
18
19
20
21
22
23
24
25

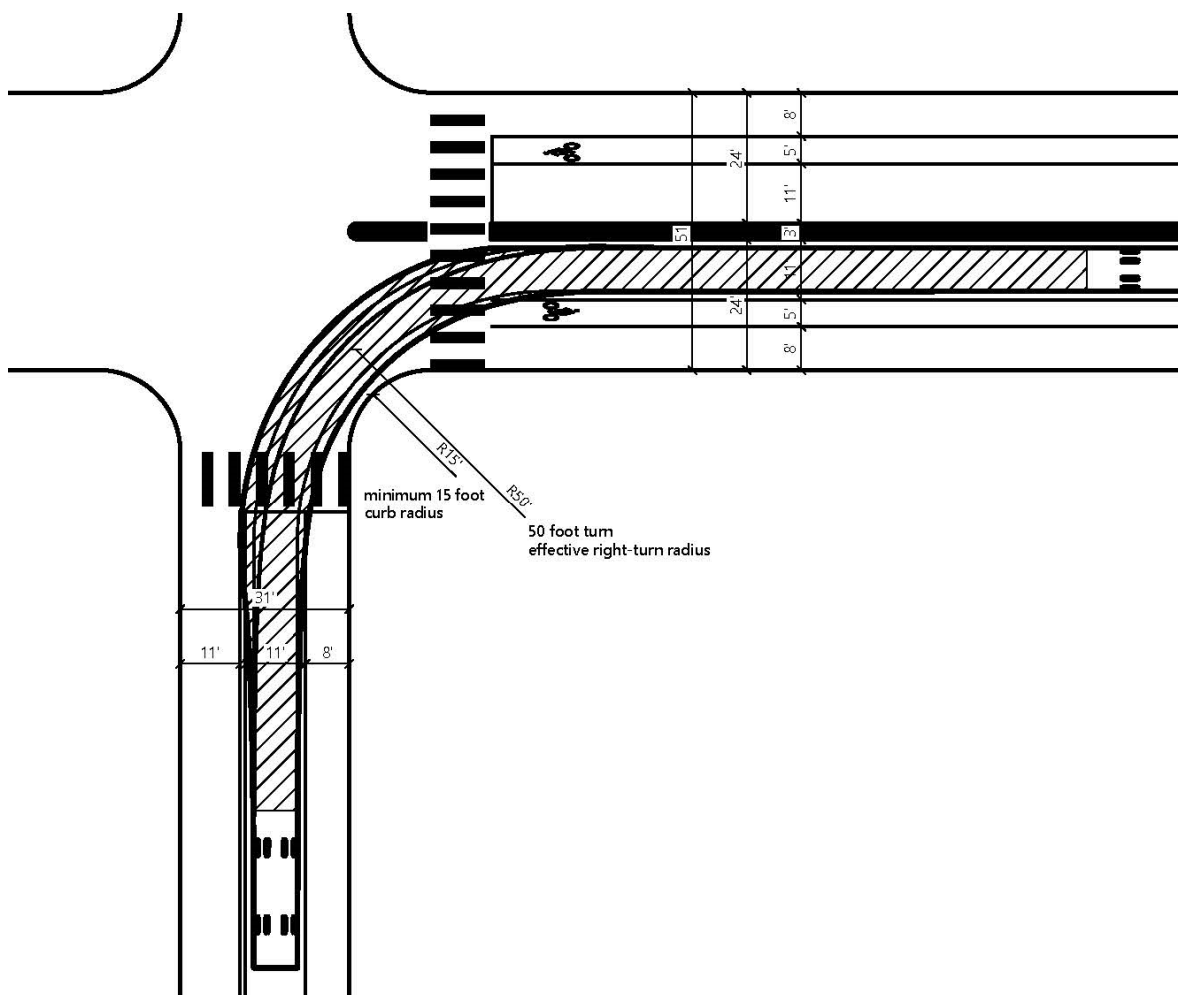

Figure 3
Effective Turning Radius for Intersections with Bike Lanes or Parking

1
2
3
4
5
6
7
8
9
10
11
12
13
14
15
16
17
18
19
20
21
22
23
24
25

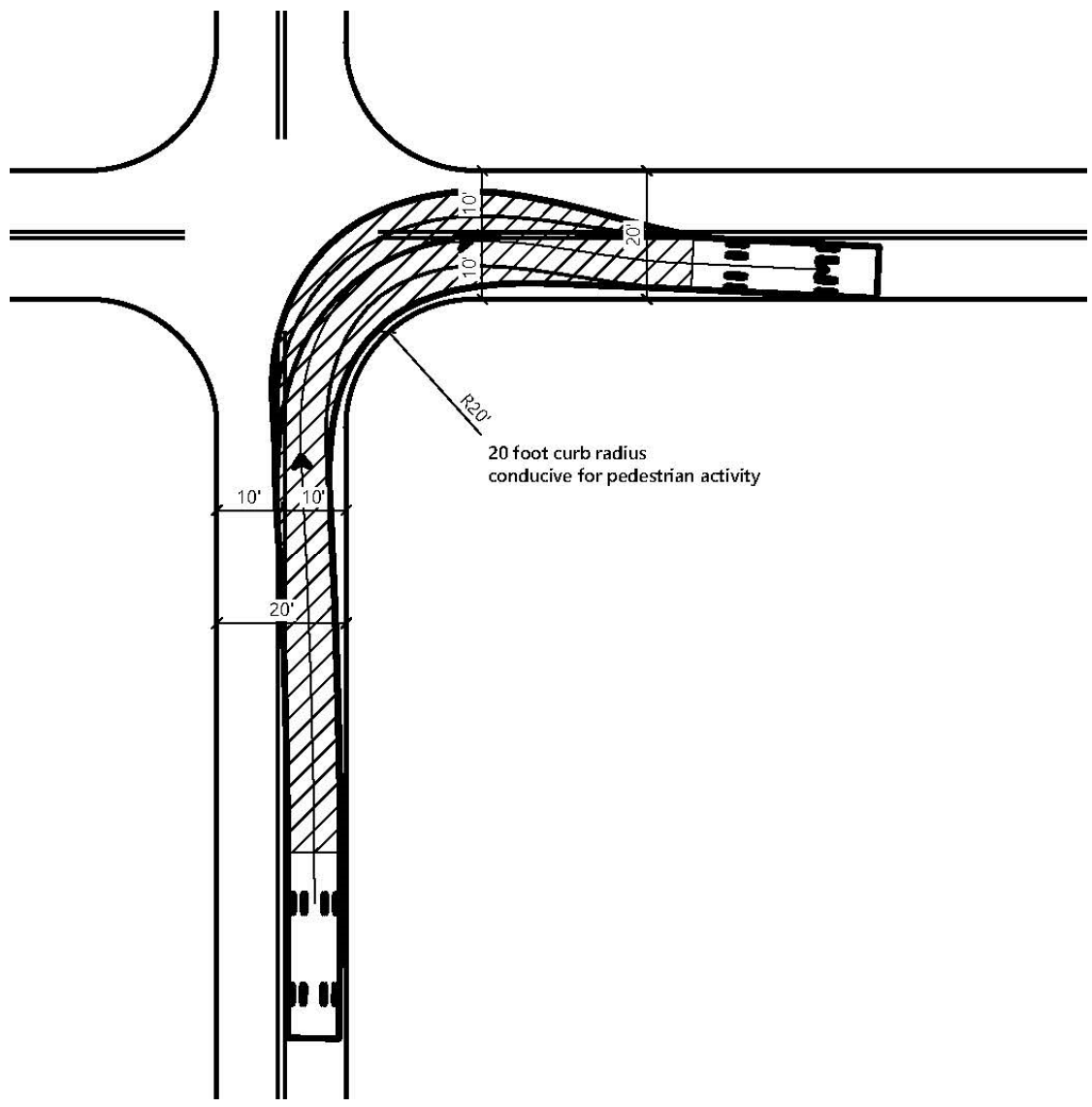

Figure 4
Effective Turning Radius for 20 Foot Wide Road Intersection

1 ~~(a) All roads shall be constructed to provide a minimum of two~~
2 ~~ten (10) foot traffic lanes, not including shoulder and~~
3 ~~striping. These traffic lanes shall provide for two-way traffic~~
4 ~~flow to support emergency vehicle and civilian egress, unless~~
5 ~~other standards are provided in this article or additional~~
6 ~~requirements are mandated by Local Jurisdictions or local~~
7 ~~subdivision requirements. Vertical clearances shall conform to~~
8 ~~the requirements in California Vehicle Code section 35250.~~

9 ~~(b) All one-way roads shall be constructed to provide a minimum~~
10 ~~of one twelve (12) foot traffic lane, not including shoulders.~~
11 ~~The Local Jurisdiction may approve one-way roads.~~

12 ~~(1) All one-way roads shall, at both ends, connect to a road~~
13 ~~with two traffic lanes providing for travel in different~~
14 ~~directions, and shall provide access to an area currently zoned~~
15 ~~for no more than ten (10) residential units.~~

16 ~~(2) In no case shall a one way road exceed 2,640 feet in length.~~
17 ~~A turnout shall be placed and constructed at approximately the~~
18 ~~midpoint of each one-way road.~~

19 ~~(c) All driveways shall be constructed to provide a minimum of~~
20 ~~one (1) ten (10) foot traffic lane, fourteen (14) feet~~
21 ~~unobstructed horizontal clearance, and unobstructed vertical~~
22 ~~clearance of thirteen feet, six inches (13' 6").~~

23 Note: Authority cited: Section 4290, Public Resources Code.

24 Reference: Sections 4290 and 4291, Public Resources Code.

1 § 1273.02. Road and Driveway Surfaces.

2 (a) Roads and appurtenant driving surfaces that supplement the
3 Traffic Lane shall be ~~designed and maintained to~~ support the
4 imposed load of ~~Fire~~ Apparatus weighing at least 75,000
5 pounds., ~~and provide an aggregate base.~~ The surface material of
6 the Road shall be non-erodible (including, but not limited to, a
7 binding agent, gravel, lime slurry, or pavement) and designed to
8 support the required weight at all times, including during
9 saturated soil conditions.

10 (b) Driveways and and appurtenant driving surfaces that
11 supplement the Driveway ~~road and driveway structures~~ shall be
12 designed and maintained to support at least 36,000 ~~40,000~~
13 pounds.

14 (c) ~~The~~ Project proponent shall provide certified engineered
15 engineering specifications to support the Road or Driveway
16 design, if requested by the AHJ ~~Local~~ authority having
17 jurisdiction.

18 Note: Authority cited: Section 4290, Public Resources Code.
19 Reference: Sections 4290 and 4291, Public Resources Code.

20 § 1273.03. Bridges or Elevated Structures on Roads and
21 Driveways. ~~Grades.~~

22 (a) Signing in conformance with the requirements in Article 3
23 (Signing and Building Numbering), shall reflect the capability
24 of each New bridge or elevated structure, including but not
25 limited to weight or vertical clearance limitations, one-way

1 road or single Traffic Lane conditions, or bridge weight rating
2 limits.

3 (b) **New** Bridges and elevated structures shall be designed and
4 constructed to accommodate a gross vehicle weight rating of
5 75,000 pounds. **If an Existing Bridge or elevated structure**
6 **provides Access to Building Construction, ~~the~~ vehicle load limits**
7 **shall be posted at both entrances to bridges when the weight**
8 **rating is less than 75,000 pounds.**

9 ~~(1) Bridges or elevated structures may support a maximum~~
10 ~~weight of less than 75,000 pounds if the Fire Authority verifies~~
11 ~~that the Fire Apparatus most likely to be used will be under the~~
12 ~~maximum load weight of the bridge.~~

13 ~~(2) If the bridge or elevated structure is designed for a~~
14 ~~lower weight, then it shall be identified through signing as~~
15 ~~required in [Article 3 \(Signing and Building Numbering\)](#). In no~~
16 ~~case shall the bridge or elevated structure be designed to~~
17 ~~support a weight below 36,000 pounds.~~

18 **(c)** ~~(3)~~ American Association of State Highway and Transportation
19 Officials (AASHTO) Standard Specifications for Highway Bridges,
20 17th Edition, published 2002 (known as AASHTO HB-17), hereby
21 incorporated by reference, may be used **to confirm that a New**
22 **bridge or elevated structure meets the weight rating of 75,000**
23 **pounds if the bridge or elevated structure is in lieu of total**
24 **vehicle weight if bridges and elevated structures are** designed
25 and certified by a Professional Engineer, as described within
the Professional Engineers Act (Chapter 7 of Division 3 of the

1 Business and Professions Code).

2 (~~e~~) Where elevated **structures** ~~surfaces~~ designed for Fire
3 Apparatus use are adjacent to surfaces which are not designed
4 for such use, barriers, signs, and/or other distinguishing
5 features, as approved by the **AHJ Local Jurisdiction**, shall be
6 installed and maintained.

7 (~~e~~) ~~Notwithstanding the above requirements, a bridge or~~
8 ~~elevated structure with only one Traffic Lane satisfies the~~
9 ~~requirements of this section so long as it provides for~~
10 ~~unobstructed visibility from one end to the other and Turnouts~~
11 ~~at both ends.~~ Bridges or elevated structures with only one
12 Traffic Lane shall be consistent with requirements outlined in [§](#)
13 [1273.05 \(Road and Driveway Traffic Lane Width and Clear Width\)](#).

14 (~~e~~) **New** Bridges and elevated structures shall be constructed of
15 non-combustible materials.

16 (~~a~~) At no point shall the grade for all roads and driveways
17 exceed 16 percent.

18 (~~b~~) The grade may exceed 16%, not to exceed 20%, with approval
19 from the local authority having jurisdiction and with
20 mitigations to provide for same practical effect.

21 Note: Authority cited: Section 4290, Public Resources Code.

22 Reference: Sections 4290 and 4291, Public Resources Code.

23 § 1273.04. Road and Driveway Grades. ~~Radius.~~

24 (a) The grades for all **New** Roads and **New** Driveways shall not
25 exceed sixteen (16) percent.

1 (b) Notwithstanding subsection (a), Road or Driveway grades of
2 16 to 20 percent satisfy the requirements of this section if the
3 New Road or New Driveway has been treated to prevent slippage
4 (including, but not limited to, aggregate treatments, binding
5 agents, and/or paving) and scraping.

6 (c) Grade transitions on New Roads and New Driveways shall be
7 constructed and designed to accommodate maximum approach and
8 departure angles of twelve (12) degrees.

9 ~~(a) No road or road structure shall have a horizontal inside
10 radius of curvature of less than fifty (50) feet. An additional
11 surface width of four (4) feet shall be added to curves of 50-
12 100 feet radius; two (2) feet to those from 100-200 feet.~~

13 ~~(b) The length of vertical curves in roadways, exclusive of
14 gutters, ditches, and drainage structures designed to hold or
15 divert water, shall be not less than one hundred (100) feet.~~

16 Note: Authority cited: Section 4290, Public Resources Code.

17 Reference: Sections 4290 and 4291, Public Resources Code.

18
19
20 § 1273.05. Road and Driveway Traffic Lane Width and Clear Width
21 Turnarounds.

22 (a) All New bidirectional Roads shall provide a minimum of two
23 ten (10) foot Traffic Lanes, not including Shoulders or
24 striping. Where topographic or other limitations require the two
25 Traffic Lanes to be constructed non-adjacently, each Traffic
Lane shall provide a minimum of twelve (12) feet.

1 (b) New bidirectional Roads with a center median shall maintain
2 a Clear Width of 20 feet on either side of the median. This
3 Clear Width may include bike lanes, Shoulders, or flexible
4 barriers used as traffic calming devices or to delineate a
5 bicycle facility, or for other uses.

6 (c) All-New One-way Roads shall provide a minimum of one twelve
7 (12) foot Traffic Lane. New one-way Roads shall maintain a Clear
8 Width of 20 feet. This Clear Width may include bike lanes,
9 Shoulders, or flexible barriers used as traffic calming devices
10 or to delineate a bicycle facility, or for other uses.

11 ~~(c) One-way Roads shall maintain a Clear Width of 20 feet.~~
12 ~~Bidirectional Roads with a center median shall maintain a Clear~~
13 ~~Width of 20 feet on either side of the median. This Clear Width~~
14 ~~may include bike lanes, Shoulders, or flexible barriers used as~~
15 ~~traffic calming devices or to delineate a bicycle facility, or~~
16 ~~for other uses.~~

17 (d) All-New Driveways shall be constructed to provide a minimum
18 of one (1) ten (10) foot Traffic Lane, and fourteen (14) feet
19 Clear Width, and unobstructed Vertical Clearance of thirteen
20 feet, six inches (13' 6").

21 (a) ~~Turnarounds are required on driveways and dead end roads.~~

22 (b) ~~The minimum turning radius for a turnaround shall be forty~~
23 ~~(40) feet, not including parking, in accordance with the figures~~
24 ~~in 14 CCR §§ 1273.05(e) and 1273.05(f). If a hammerhead/T is~~
25 ~~used instead, the top of the "T" shall be a minimum of sixty~~

1 ~~(60) feet in length.~~

2 ~~(c) Driveways exceeding 150 feet in length, but less than 800~~
3 ~~feet in length, shall provide a turnout near the midpoint of the~~
4 ~~driveway. Where the driveway exceeds 800 feet, turnouts shall be~~
5 ~~provided no more than 400 feet apart.~~

6 ~~(d) A turnaround shall be provided on driveways over 300 feet in~~
7 ~~length and shall be within fifty (50) feet of the Building.~~

8 ~~(d) Each dead end road shall have a turnaround constructed at~~
9 ~~its terminus. Where parcels are zoned five (5) acres or larger,~~
10 ~~turnarounds shall be provided at a maximum of 1,320 foot~~
11 ~~intervals.~~

12 ~~(e) Figure A. Turnarounds on roads with two ten-foot traffic~~
13 ~~lanes.~~

14 ~~Figure A/Image 1 is a visual representation of paragraph (b).~~

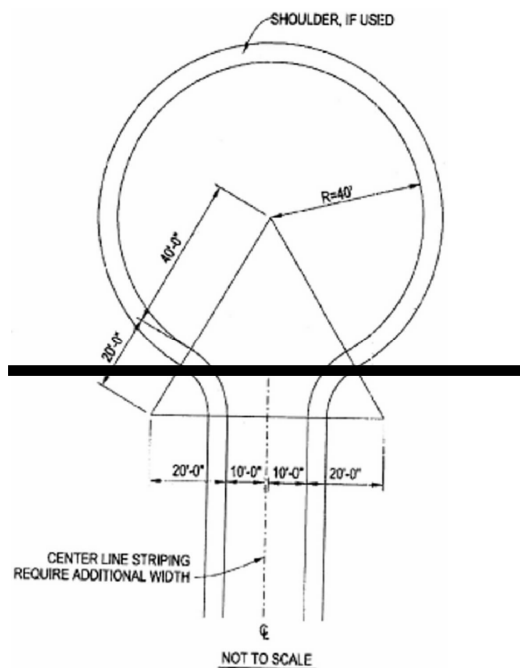

25 Note: Authority cited: Section 4290, Public Resources Code.

1 Reference: Sections 4290 and 4291, Public Resources Code.

2
3 § 1273.06 Road and Driveway Vertical Clearances ~~Turnouts~~

4 Roads and Driveways shall provide for a minimum of thirteen feet
5 and six inches (13' 6") of unobstructed Vertical Clearance.

6 ~~Turnouts shall be a minimum of twelve (12) feet wide and thirty~~
7 ~~(30) feet long with a minimum twenty five (25) foot taper on~~
8 ~~each end.~~

9 Note: Authority cited: Section 4290, Public Resources Code.

10 Reference: Sections 4290 and 4291, Public Resources Code.

11
12 § 1273.07 Maximum Lengths of New One-Way Roads ~~Road and~~

13 ~~Driveway Structures~~

14 (a) In no case shall a New One-Way Road exceed 2,640 feet in
15 length.

16 ~~(a) Appropriate signing, including but not limited to weight or~~
17 ~~vertical clearance limitations, one-way road or single traffic~~
18 ~~lane conditions, shall reflect the capability of each bridge.~~

19 ~~(b) Where a bridge or an elevated surface is part of a fire~~
20 ~~apparatus access road, the bridge shall be constructed and~~
21 ~~maintained in accordance with the American Association of State~~
22 ~~and Highway Transportation Officials Standard Specifications for~~
23 ~~Highway Bridges, 17th Edition, published 2002 (known as AASHTO~~
24 ~~HB-17), hereby incorporated by reference. Bridges and elevated~~
25 ~~surfaces shall be designed for a live load sufficient to carry~~

1 ~~the imposed loads of fire apparatus. Vehicle load limits shall~~
2 ~~be posted at both entrances to bridges when required by the~~
3 ~~local authority having jurisdiction.~~

4 ~~(c) Where elevated surfaces designed for emergency vehicle use~~
5 ~~are adjacent to surfaces which are not designed for such use,~~
6 ~~barriers, or signs, or both, as approved by the local authority~~
7 ~~having jurisdiction, shall be installed and maintained.~~

8 ~~(d) A bridge with only one traffic lane may be authorized by the~~
9 ~~local jurisdiction; however, it shall provide for unobstructed~~
10 ~~visibility from one end to the other and turnouts at both ends.~~

11 Note: Authority cited: Section 4290, Public Resources Code.

12 Reference: Sections 4290 and 4291, Public Resources Code.

13
14 § 1273.08 Maximum Lengths of New Dead-end Roads

15 (a) ~~The maximum length of a New Dead-end Road, including all~~
16 ~~dead-end roads accessed from that dead-end road, shall not~~
17 ~~exceed the following cumulative lengths, regardless of the~~
18 ~~number of parcels served:~~

19 (1) for **New** Roads with parcels zoned for less than not to
20 exceed one (1) acre - 800 feet;

21 (2) for **New** Roads with parcels zoned for 1 acre up to 4.99
22 acres - 1,320 feet;

23 (3) for **New** Roads with parcels zoned for 5 acres to 19.99
24 or larger - 2,640 feet.

25 ~~parcels zoned for 20 acres or larger - 5,280 feet~~

1 ~~All lengths shall be measured from the edge of the road surface~~
2 ~~at the intersection that begins the road to the end of the road~~
3 ~~surface at its farthest point. Where a dead end road crosses~~
4 ~~areas of differing zoned parcel sizes requiring different length~~
5 ~~limits, the shortest allowable length shall apply.~~

6 (b) All New Dead-end Roads shall meet the Turnaround
7 requirements in [§ 1273.10 \(Road and Driveway Turnarounds\)](#). See 14
8 CCR ~~§ 1273.05 for dead end road turnaround requirements.~~

9 (c) All New Dead-end Roads shall meet the width requirements in
10 [§ 1273.05 \(Road and Driveway Traffic Lane Width and Clear](#)
11 [Width\)](#).

12 (d) Each New Dead-end Road shall be connected **either:**
13 **(1)** directly to a through Road (a Road that is connected to
14 other Roads at both ends); or
15 **(2) an Existing Dead-end Road constructed prior to July 1,**
16 **2022.**

17 (e) The length of New Dead-end Roads shall be measured from the
18 center line of the through Road it connects to, to the terminus
19 of the Dead-end Road at its farthest point.

20 (f) Where a New Dead-end Road provides access to differing
21 zoned parcel sizes requiring different length limits, the
22 shortest allowable length shall apply.

23 Note: Authority cited: Section 4290, Public Resources Code.
24 Reference: Sections 4290 and 4291, Public Resources Code.

1 § 1273.09 Road and Driveway Turnouts ~~Gate Entrances~~

2 (a) Turnouts shall be a minimum of twelve (12) feet wide from
3 the shoulder stripe, twenty-two (22) feet long with a minimum
4 twenty-five (25) foot taper on each end and be facilitated
5 outside of the Traffic Lane to accommodate one passenger vehicle
6 as illustrated on Figure 5.

7 (b) On One-way Roads and Dead-end Roads over 400 feet in length,
8 a Turnout shall be located at approximately the midpoint of the
9 Road, in addition to any other Turnouts Required.

10 (c) Turnouts shall be provided no more than 400 feet apart on
11 One-way Roads or on Roads that do not meet the width
12 requirements.

13 (d) Driveways that are less than 20 feet wide and exceed 150
14 feet in length shall require a Turnout.

15 (e) Driveways greater than 150 feet in length and less than 800
16 feet in length shall provide a Turnout near the midpoint of the
17 Driveway.

18 (f) Where the Driveway exceeds 800 feet, Turnouts shall be
19 provided no more than 400 feet apart.

20 (g) No parking, obstructions, or storage of any material shall
21 be allowed within Turnouts.

1
2
3
4
5
6
7
8
9
10
11
12
13
14
15
16
17
18
19
20
21
22
23
24
25

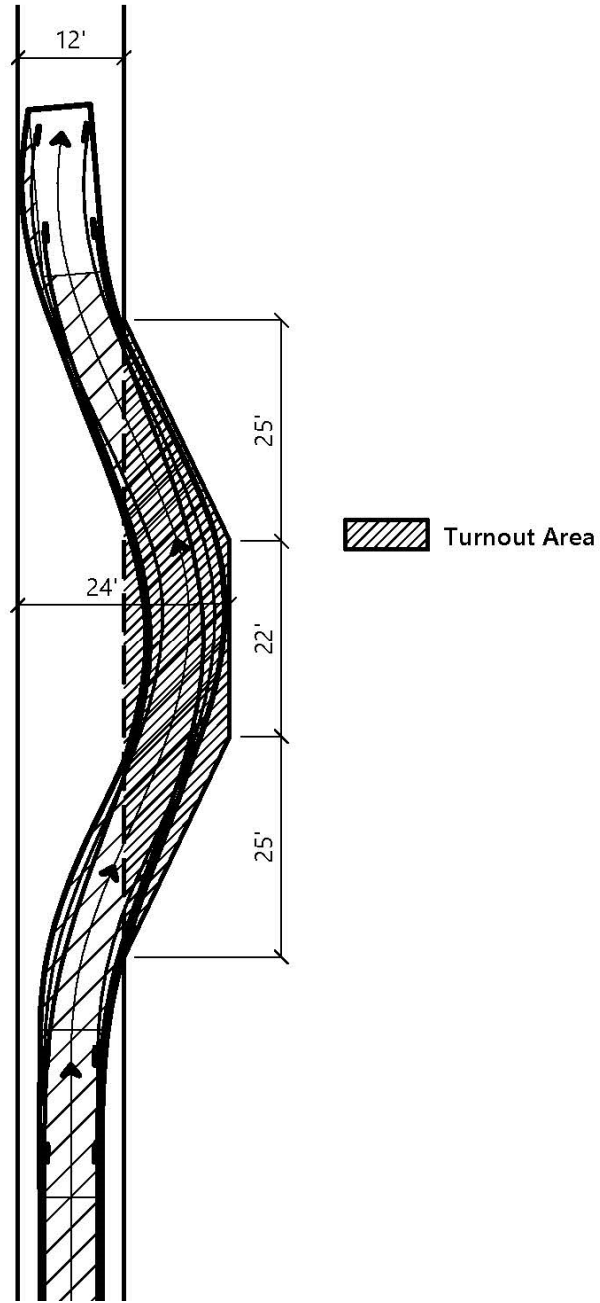

Figure 5
Turnout Dimensions

1 ~~(a) Gate entrances shall be at least two (2) feet wider than the~~
2 ~~width of the traffic lane(s) serving that gate and a minimum~~
3 ~~width of fourteen (14) feet unobstructed horizontal clearance~~
4 ~~and unobstructed vertical clearance of thirteen feet, six inches~~
5 ~~(13' 6").~~

6 ~~(b) All gates providing access from a road to a driveway shall~~
7 ~~be located at least thirty (30) feet from the roadway and shall~~
8 ~~open to allow a vehicle to stop without obstructing traffic on~~
9 ~~that road.~~

10 ~~(c) Where a one way road with a single traffic lane provides~~
11 ~~access to a gated entrance, a forty (40) foot turning radius~~
12 ~~shall be used.~~

13 ~~(d) Security gates shall not be installed without approval.~~
14 ~~Where security gates are installed, they shall have an approved~~
15 ~~means of emergency operation. Approval shall be by the local~~
16 ~~authority having jurisdiction. The security gates and the~~
17 ~~emergency operation shall be maintained operational at all~~
18 ~~times.~~

19 Note: Authority cited: Section 4290, Public Resources Code.

20 Reference: Sections 4290 and 4291, Public Resources Code.

21
22 § 1273.10 Road and Driveway Turnarounds

23 ~~(a) Each Dead-end Road shall have a Turnaround constructed at~~
24 ~~its terminus. Where a Dead-end Road crosses parcels zoned for~~
25 ~~five (5) acres or larger, a Turnaround shall also be provided~~

1 halfway along the Dead-end Road.

2 (b) A Turnaround shall be provided on Driveways over 300 feet in
3 length and shall be within fifty (50) feet of the Building.

4 (c) A Turnaround shall meet ~~one~~ **all** of the following
5 requirements **in subsections (d), (e), and (f), and shall be in**
6 accordance with Figures 6.1, 6.2, or 6.3.

7
8 (d) Turnarounds with a radius smaller than 40 feet, shown in
9 Figures 6.2 and 6.3 below, may be approved by the AHJ ~~Local~~
10 ~~Jurisdiction~~ when physical constraints prohibit the ability to
11 install a 40-foot Turnaround.

12 (e) The center of the Turnaround shall remain clear of
13 vegetation or decorative elements.

14 (f) If a hammerhead/T is used instead, the top of the "T" shall
15 be a minimum of sixty (60) feet in length.

1
2
3
4
5
6
7
8
9
10
11
12
13
14
15
16
17
18
19
20
21
22
23
24
25

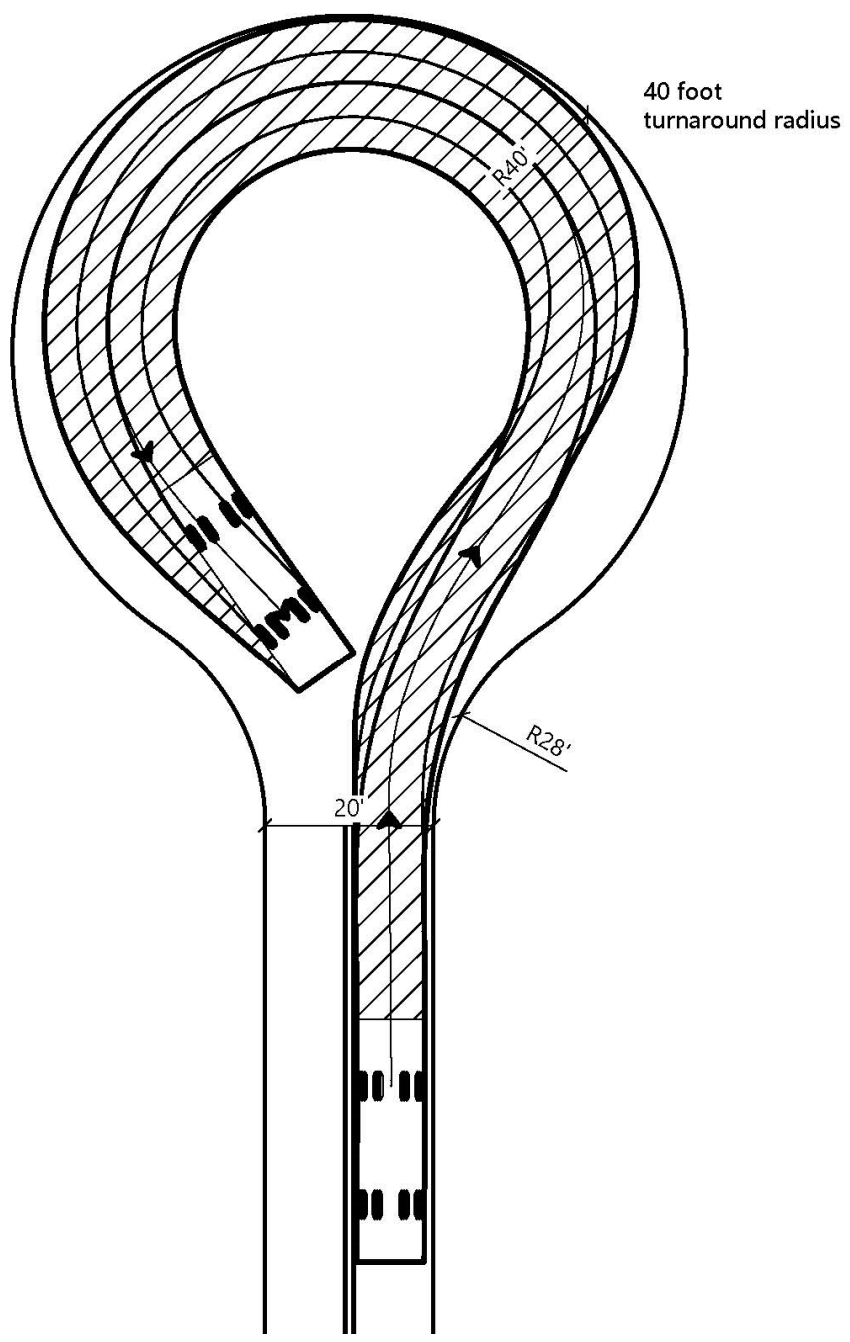

Figure 6.1
Turnarounds with 40-foot radius

1
2
3
4
5
6
7
8
9
10
11
12
13
14
15
16
17
18
19
20
21
22
23
24
25

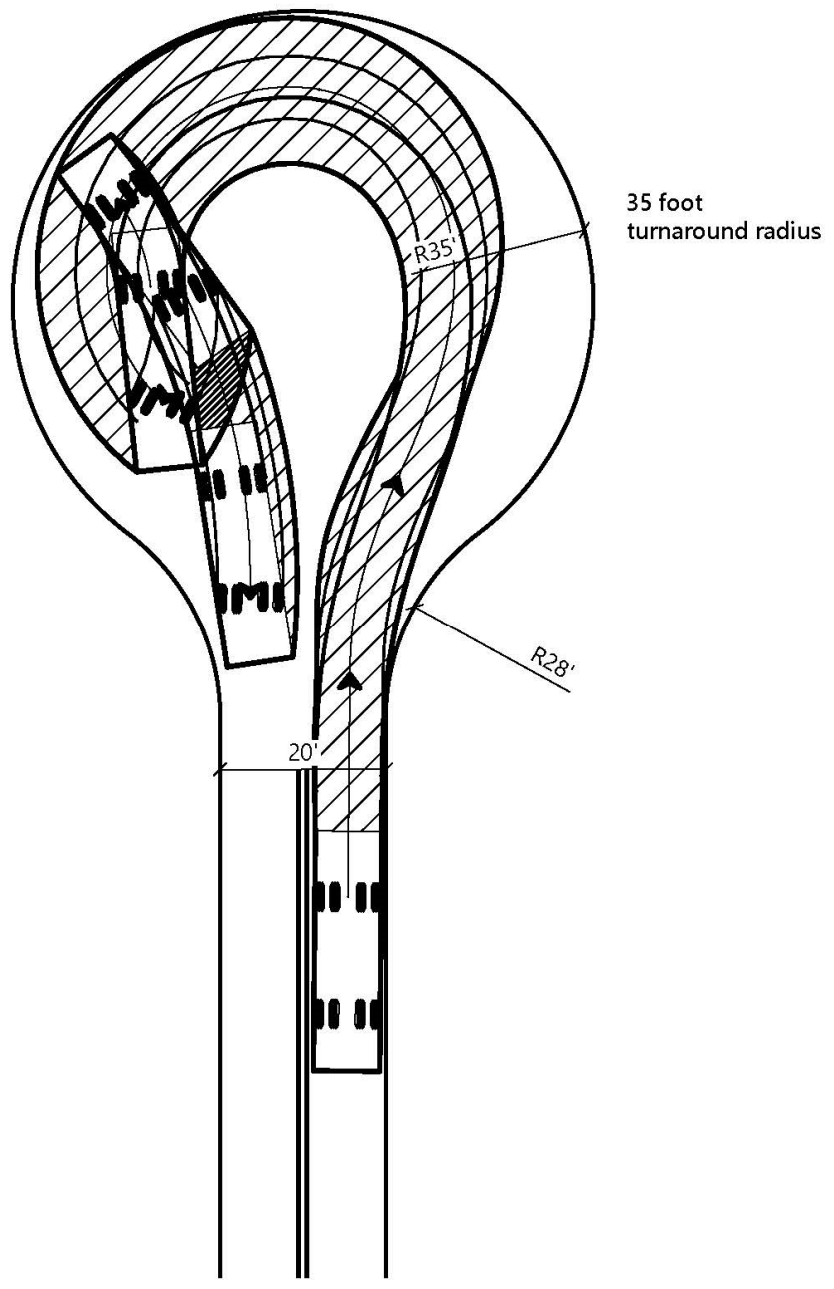

Figure 6.2
Turnarounds with 35-foot radius

1
2
3
4
5
6
7
8
9
10
11
12
13
14
15
16
17
18
19
20
21
22
23
24
25

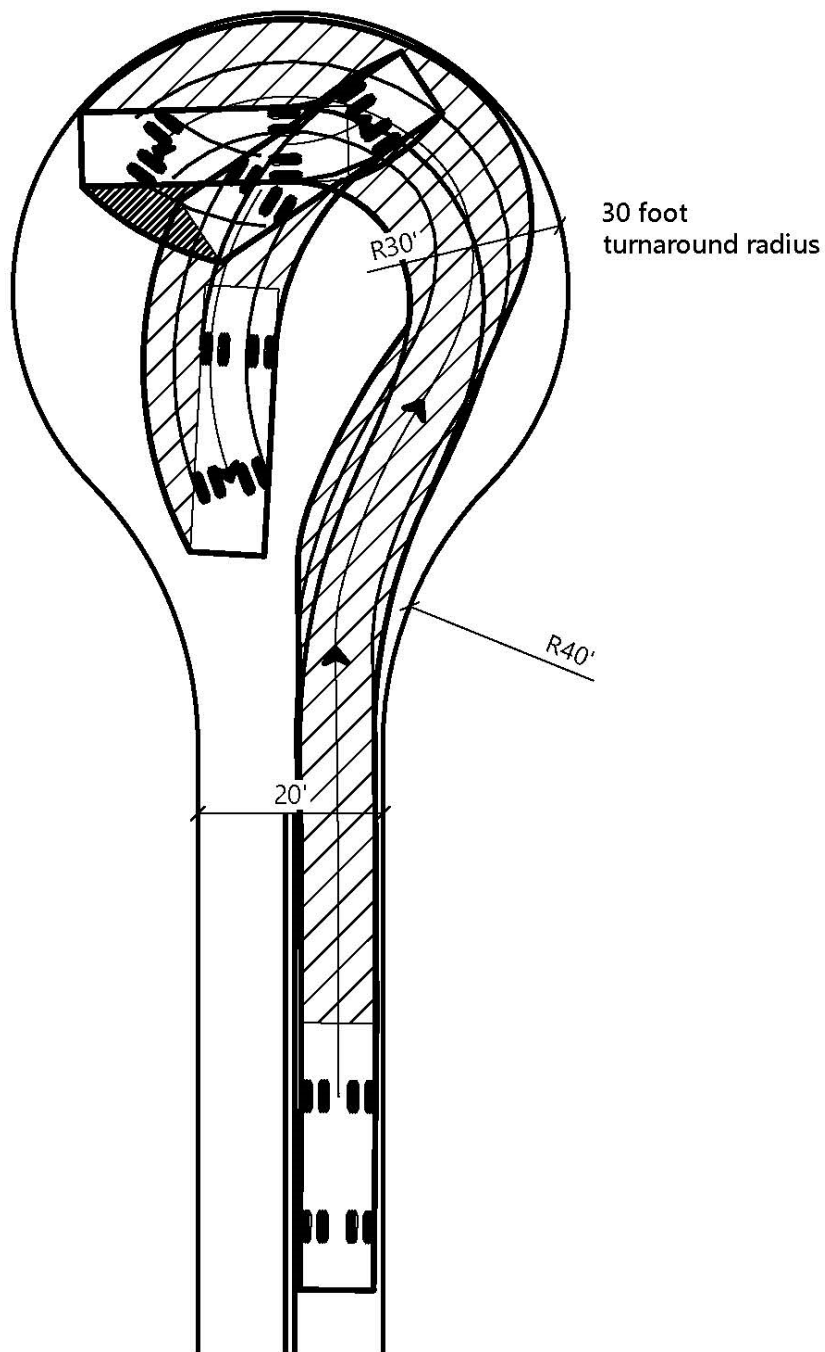

Figure 6.3
Turnarounds with 30-foot radius

1 Note: Authority cited: Section 4290, Public Resources Code.

2 Reference: Sections 4290 and 4291, Public Resources Code.

3
4 § 1273.11 Gates

5 (a) Gates shall have an approved means of emergency operation.

6 Electronic gates shall have a manual method of opening in case
7 of electronic failure. The manual method shall be maintained to
8 be operational at all times.

9 (b) Gate entrances shall be at least two (2) feet wider than the
10 width of the Road or Driveway, as shown in Figure 7 below. Where
11 a gate is installed across an existing Road or Driveway, the
12 gate shall be no less than ten (10) feet wide, with a minimum
13 Clear Width of fourteen (14) feet and unobstructed Vertical
14 Clearance of thirteen feet, six inches (13' 6"). Clearance shall
15 be maintained at all times.

16 (c) Where a One-way Road with a single Traffic Lane leads to a
17 gated entrance, a forty (40) foot turning radius shall be
18 provided ~~used~~ as illustrated on Figure 7.

19 (d) All gates on a Driveway shall be located at least thirty
20 (30) feet from the Road and shall either slide sideways or open
21 to allow a vehicle to stop without stopping traffic on the Road,
22 in direction of travel, in accordance with Figure 7.

1
2
3
4
5
6
7
8
9
10
11
12
13
14
15
16
17
18
19
20
21
22
23
24
25

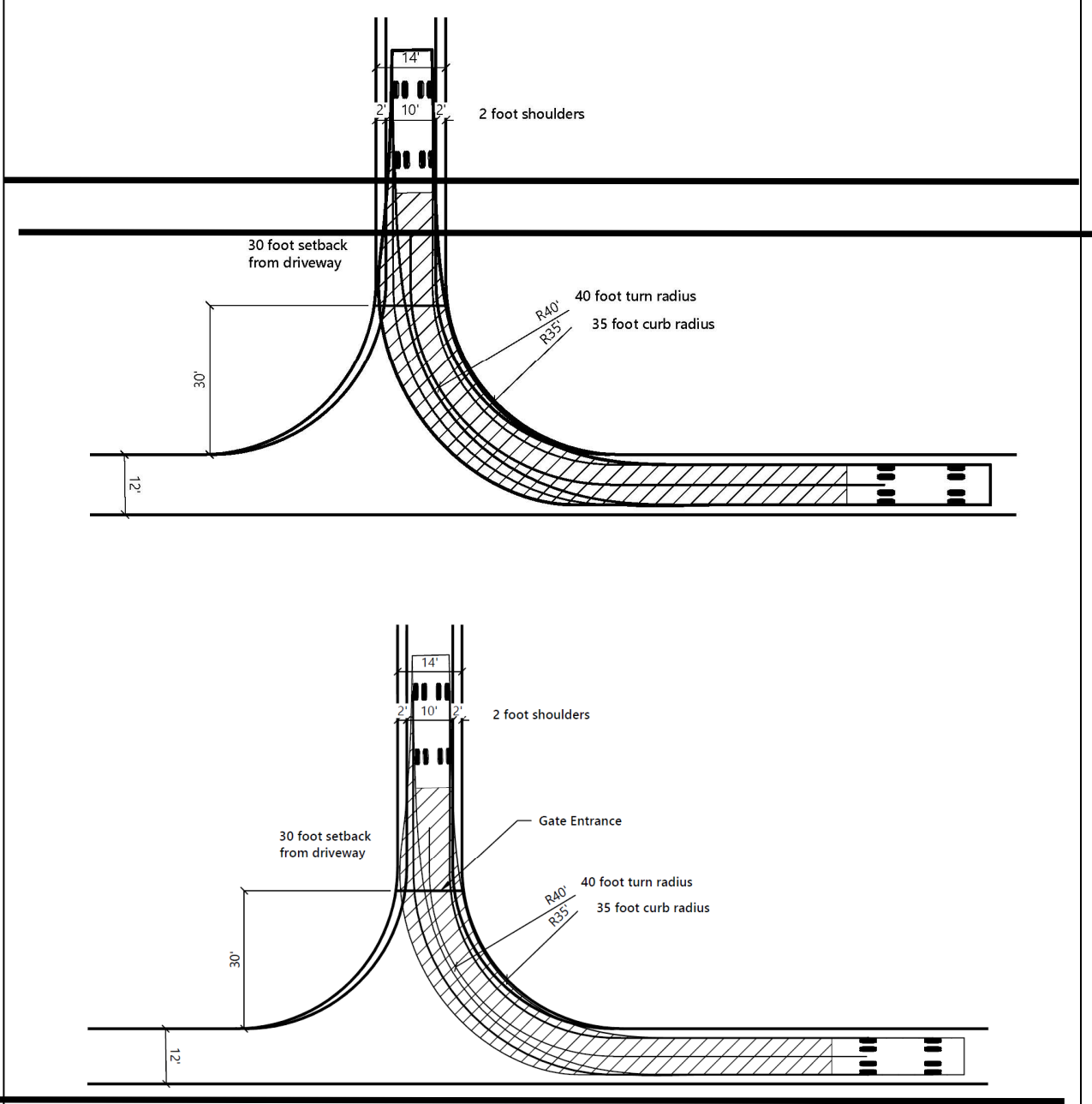

Figure 7
Effective Turn Radius for Gated Entrances/Driveways with Twelve Foot One-Way Main Road

Note: Authority cited: Section 4290, Public Resources Code.

Reference: Sections 4290 and 4291, Public Resources Code.

1 § 1273.12 Standards for Existing Roads

2 (a) Except as provided in subsections (b) and (d), Existing
3 Roads that provide Access to New Building Construction along at
4 least one route shall meet the following minimum requirements:

5 (1) One (1) fourteen (14) foot Traffic Lane;

6 (2) Surfacing which supports the imposed load of Fire
7 Apparatus, subject to the standards set forth in § 1273.02.
8 ~~Native surfacing for no more than 50% of the Road's length; and~~

9 (3) Turnouts in compliance with § 1273.09 (Road and
10 Driveway Turnouts), or maintains a twenty (20) foot Clear Width
11 suitable to serve as a Traffic Lane for the length of the Road.

12 ~~(b) Access to Buildings after a Wildfire shall provide for at~~
13 ~~least one (1) fourteen (14) foot Traffic Lane for a distance of~~
14 ~~at least twenty two (22) feet at an interval of at least every~~
15 ~~400 feet; provided, however, where such Traffic Lanes are not~~
16 ~~possible due to physical site limitations such as localized~~
17 ~~topography, slope stability or soil conditions, Access shall~~
18 ~~provide for locations for vehicles to pass each other at~~
19 ~~reasonable intervals.~~

20 ~~(c)~~ Existing Roads providing Access to Buildings shall not
21 exceed a grade of 25% over a distance of 500 linear feet.

22 ~~(d)~~ An Existing Road with a secondary route in conformance with
23 the conditions below § 1273.13 (Secondary Routes for Existing
24 Roads) need not comply with subsections (a) or (b).

25 (1) Secondary routes shall meet the standards for New Roads
in this Subchapter and shall provide for legal Access that

1 serves as a typical travel way to and from the Building
2 Construction. A secured secondary route shall meet the
3 requirements in § 1273.11 (Gates).

4 (2) Secondary routes shall connect a user to an alternative
5 route that would not be affected by a closure to the primary
6 route, to the extent practicable.

7 Note: Authority cited: Section 4290, Public Resources Code.
8 Reference: Sections 4290 and 4291, Public Resources Code,
9 Section 51178 Government Code.

10
11 ~~§ 1273.13 Secondary Routes for Existing Roads~~

12 ~~(a) Secondary routes shall meet the standards for New Roads in~~
13 ~~this Subchapter and shall provide for legal and deeded Access~~
14 ~~that serves as a typical travel way to and from the Building~~
15 ~~construction. A secured secondary route shall meet the~~
16 ~~requirements in § 1273.11 (Gates).~~

17 ~~(b) Secondary routes shall connect a user to an alternative~~
18 ~~route that would not be affected by a closure to the primary~~
19 ~~route, to the extent practicable.~~

20 ~~Note: Authority cited: Section 4290, Public Resources Code.~~
21 ~~Reference: Sections 4290 and 4291, Public Resources Code.~~

22
23 Article 3. Signing and Building Numbering

24 § 1274.00. Road Name Signs. Intent

25 (a) All Road signs shall conform to the requirements of the
California Manual of Uniform Traffic Control Devices (CA MUTCD),

1 ~~hereby incorporated by reference.~~

2 (ba) New Roads shall be identified by a name or number through a
3 consistent system that provides for sequenced or patterned
4 numbering and non-duplicative naming within each Local
5 Jurisdiction. This section does not require any entity to rename
6 or renumber existing roads.

7 (eb) The size of letters, numbers, and symbols for road signs
8 shall be a minimum four (4) inch letter height, half inch (.5)
9 inch stroke, reflectorized, contrasting with the background
10 color of the sign.

11 ~~To facilitate locating a fire and to avoid delays in response,~~
12 ~~all newly constructed or approved roads and Buildings shall be~~
13 ~~designated by names or numbers posted on signs clearly visible~~
14 ~~and legible from the road. This section shall not restrict the~~
15 ~~size of letters or numbers appearing on road signs for other~~
16 ~~purposes.~~

17 Note: Authority cited: Section 4290, Public Resources Code.

18 Reference: Sections 4290 and 4291, Public Resources Code.

19
20 § 1274.01. Road Signs Installation, Location, and Visibility.

21 (a) All Road signs shall conform to the requirements of the
22 California Manual of Uniform Traffic Control Devices (CA MUTCD),
23 hereby incorporated by reference.

24 (b) Signs required by this article identifying intersecting
25 roads shall be placed at the intersection of those roads.

1 ~~(bc)~~ A sign identifying traffic limitations, including but not
2 limited to weight or Vertical Clearance limitations, Dead-end
3 Roads, One-way Roads, or single lane Roads and bridges, shall be
4 placed:

5 (1) at the intersection preceding the traffic limitation,
6 and

7 (2) no more than one hundred (100) feet before such traffic
8 limitation.

9 ~~(ed)~~ Road signs required by this article shall be posted at the
10 beginning of construction and shall be maintained thereafter.

11 ~~(ee)~~ Road signs shall meet the minimum sign retroreflectivity
12 requirements in the CA MUTCD. Signs that are not required to
13 meet the retroreflectivity requirements (e.g., blue or brown
14 backgrounds) shall be retroreflective or illuminated to show the
15 same shape and color by both day and night.

16 ~~(a) Newly constructed or approved roads must be identified by a~~
17 ~~name or number through a consistent system that provides for~~
18 ~~sequenced or patterned numbering and/or non duplicative naming~~
19 ~~within each local jurisdiction. This section does not require~~
20 ~~any entity to rename or renumber existing roads, nor shall a~~
21 ~~road providing access only to a single commercial or industrial~~
22 ~~occupancy require naming or numbering.~~

23 ~~(b) The size of letters, numbers, and symbols for road signs~~
24 ~~shall be a minimum four (4) inch letter height, half inch (.5)~~
25 ~~inch stroke, reflectorized, contrasting with the background~~

1 ~~color of the sign.~~

2 Note: Authority cited: Section 4290, Public Resources Code.

3 Reference: Sections 4290 and 4291, Public Resources Code.

4
5 § 1274.02. Addresses for Buildings.

6 (a) All Buildings shall be issued an address by the **AHJ** ~~Local~~
7 ~~Jurisdiction~~ consistent with the standards in the California
8 Fire Code, California Code of Regulations title 24, part 9.

9 (b) Addresses for residential Buildings shall be reflectorized.

10 ~~(a) Road signs shall be visible and legible from both directions~~
11 ~~of vehicle travel for a distance of at least one hundred (100)~~
12 ~~feet.~~

13 ~~(b) Signs required by this article identifying intersecting~~
14 ~~roads shall be placed at the intersection of those roads.~~

15 ~~(c) A sign identifying traffic access or flow limitations,~~
16 ~~including but not limited to weight or vertical clearance~~
17 ~~limitations, dead-end roads, one-way roads, or single lane~~
18 ~~conditions, shall be placed:~~

19 ~~(i) at the intersection preceding the traffic access limitation,~~
20 ~~and~~

21 ~~(ii) no more than one hundred (100) feet before such traffic~~
22 ~~access limitation.~~

23 ~~(d) Road signs required by this article shall be posted at the~~
24 ~~beginning of construction and shall be maintained thereafter.~~

25 Note: Authority cited: Section 4290, Public Resources Code.

1 Reference: Sections 4290 and 4291, Public Resources Code.

2
3 ~~§ 1274.03. Addresses for Buildings.~~

4 ~~(a) All buildings shall be issued an address by the local~~
5 ~~jurisdiction which conforms to that jurisdiction's overall~~
6 ~~address system. Utility and miscellaneous Group U buildings are~~
7 ~~not required to have a separate address; however, each~~
8 ~~residential unit within a building shall be separately~~
9 ~~identified.~~

10 ~~(b) The size of letters, numbers, and symbols for addresses~~
11 ~~shall conform to the standards in the California Fire Code,~~
12 ~~California Code of Regulations title 24, part 9.~~

13 ~~(c) Addresses for residential buildings shall be reflectorized.~~

14 ~~Note: Authority cited: Section 4290, Public Resources Code.~~

15 ~~Reference: Sections 4290 and 4291, Public Resources Code.~~

16
17 ~~§ 1274.04. Address Installation, Location, and Visibility.~~

18 ~~(a) All Buildings shall have a permanently posted address which~~
19 ~~shall be plainly legible and visible from the road fronting the~~
20 ~~property.~~

21 ~~(b) Where access is by means of a private road and the address~~
22 ~~identification cannot be viewed from the public way, an~~
23 ~~unobstructed sign or other means shall be used so that the~~
24 ~~address is visible from the public way.~~

25 ~~(c) Address signs along one way roads shall be visible from both~~

1 ~~directions.~~

2 ~~(d) Where multiple addresses are required at a single driveway,~~
3 ~~they shall be mounted on a single sign or post.~~

4 ~~(e) Where a road provides access solely to a single commercial~~
5 ~~or industrial business, the address sign shall be placed at the~~
6 ~~nearest road intersection providing access to that site, or~~
7 ~~otherwise posted to provide for unobstructed visibility from~~
8 ~~that intersection.~~

9 ~~(f) In all cases, the address shall be posted at the beginning~~
10 ~~of construction and shall be maintained thereafter.~~

11 ~~Note: Authority cited: Section 4290, Public Resources Code.~~

12 ~~Reference: Sections 4290 and 4291, Public Resources Code.~~

13
14 Article 4. Water Supply. ~~Emergency Water Standards~~

15 § 1275.00. Application. ~~Intent~~

16 (a) The provisions of this Article shall apply to Newly
17 constructed water and wastewater facilities associated with New
18 Building Construction. ~~in the tentative and parcel map process~~
19 ~~when new parcels are approved by the Local Jurisdiction having~~
20 ~~authority, or when new Building construction is not already~~
21 ~~served by an existing water supply.~~

22 (b) The provisions of this Article ~~These regulations~~ shall not
23 apply to ~~Existing~~ water or wastewater facilities that are not
24 newly constructed, or to the Repair of ~~Existing~~ water or
25 wastewater facilities that are repaired, reconstructed, or

1 ~~upgraded~~. For purposes of this subsection, "water and wastewater
2 facilities" includes, but is not limited to, water storage tanks
3 and reservoirs, pump stations, treatment facilities, regulator
4 stations, Fire Hydrants, and similar water and wastewater system
5 devices.

6 (c) Where a specific ~~provision of code standard from~~ the
7 California Fire Code or of a National Fire Protection
8 Association (NFPA) standard is referenced in this Article, ~~the~~
9 ~~respective provisions of said code any sections of the~~
10 ~~California Fire Code~~ or ~~NFPA standards~~ regarding alternative
11 methods of compliance, equivalencies, or modifications to the
12 specified ~~provisions standards~~ shall also apply.

13 ~~Emergency water for Wildfire protection shall be available,~~
14 ~~accessible, and maintained in quantities and locations specified~~
15 ~~in the statute and these regulations in order to attack a~~
16 ~~Wildfire or defend property from a Wildfire.~~

17 Note: Authority cited: Section 4290, Public Resources Code.
18 Reference: Sections 4290 and 4291, Public Resources Code.

19
20 § 1275.01. Approved Water Supply. ~~Application~~

21 (a) Water supply shall meet or exceed the California Fire Code,
22 California Code of Regulations Title 24, Part 9.

23 (b) Where a Municipal-Type Water Supply is not available, the
24 ~~AHJ Local Jurisdiction~~ shall utilize the National Fire
25 Protection Association (NFPA) 1142, "Standard on Water Supplies

1 for Suburban and Rural Fire Fighting," 2022 ~~2017~~ Edition, hereby
2 incorporated by reference, as referenced in the California Fire
3 Code, California Code of Regulations Title 24, Part 9, Appendix
4 B and Appendix BB.

5 (c) All ~~New Building Construction proposals — Building~~
6 ~~construction~~ shall include a water supply for structure defense.
7 Such protection shall be serviceable prior to and during the
8 time of construction, except when alternative methods of
9 protection are provided and approved by the ~~AHJ Local~~
10 ~~Jurisdiction.~~

11 (d) Nothing in this article prohibits the combined storage of
12 Wildfire and structural firefighting water supplies unless so
13 prohibited by local ordinance or specified by the ~~AHJ Local~~
14 ~~Jurisdiction. Water supplies required under the California Fire~~
15 ~~Code, California Code of Regulations Title 24, Part 9, or other~~
16 ~~law or regulation may also be used to satisfy the requirements~~
17 ~~of this Article, so long as the full amount of water supply~~
18 ~~required by this article is provided.~~

19 (e) Where ~~water systems are susceptible to~~ freeze or crash, ~~such~~
20 protection ~~measures shall be~~ ~~is~~ required by the ~~AHJ Local~~
21 ~~Jurisdiction., such protection measures shall be provided.~~

22 The provisions of this article shall apply in the tentative and
23 parcel map process when new parcels are approved by the local
24 jurisdiction having authority.

25 Note: Authority cited: Section 4290, Public Resources Code.

1 Reference: Sections 4290 and 4291, Public Resources Code.

2
3 § 1275.02. Identification of Water Sources. ~~Water Supply.~~

4 (a) Fire Hydrants or water access located along a Driveway shall
5 be identified by at least (1) reflectorized blue marker, with a
6 minimum dimension of three (3) inches. This marker shall be
7 mounted on a ~~fire retardant~~ sign post constructed of ~~fire~~
8 ~~retardant material~~. The sign post shall be located and mounted
9 as specified by the ~~AHJ Fire Authority~~.

10 (b) Fire Hydrants or water access located along a Road shall be
11 identified by one of the following marking standards, as
12 specified by the AHJ:

13
14 (1) a reflectorized blue marker, with a minimum dimension
15 of three (3) inches. This marker shall be mounted on a ~~fire~~
16 ~~retardant~~ sign post constructed of ~~fire retardant material~~. The
17 sign post shall be within three (3) feet of the Fire Hydrant or
18 water access. The sign shall be no fewer than three (3) nor
19 greater than five (5) feet above ground, in a horizontal
20 position, and visible from the Road, or as specified by the AHJ
21 ~~Fire Authority~~.

22 (2) a reflectorized blue marker secured to the center of
23 the road pavement, as specified by the AHJ.

24 ~~(a) When a water supply for structure defense is required to be~~
25 ~~installed, such protection shall be installed and made~~

1 ~~serviceable prior to and during the time of construction except~~
2 ~~when alternative methods of protection are provided and approved~~
3 ~~by the local authority having jurisdiction.~~

4 ~~(b) Water systems equaling or exceeding the California Fire~~
5 ~~Code, California Code of Regulations title 24, part 9, or, where~~
6 ~~a municipal type water supply is unavailable, National Fire~~
7 ~~Protection Association (NFPA) 1142, "Standard on Water Supplies~~
8 ~~for Suburban and Rural Fire Fighting," 2017 Edition, hereby~~
9 ~~incorporated by reference, shall be accepted as meeting the~~
10 ~~requirements of this article.~~

11 ~~(c) Such emergency water may be provided in a fire agency mobile~~
12 ~~water tender, or naturally occurring or man made containment~~
13 ~~structure, as long as the specified quantity is immediately~~
14 ~~available.~~

15 ~~(d) Nothing in this article prohibits the combined storage of~~
16 ~~emergency Wildfire and structural firefighting water supplies~~
17 ~~unless so prohibited by local ordinance or specified by the~~
18 ~~local fire agency.~~

19 ~~(e) Where freeze or crash protection is required by Local~~
20 ~~Jurisdictions having authority, such protection measures shall~~
21 ~~be provided.~~

22 Note: Authority cited: Section 4290, Public Resources Code.

23 Reference: Sections 4290 and 4291, Public Resources Code.

1 § 1275.03. Secured Water Sources. Hydrants and Fire Valves.

2 Break away locks or similar systems shall be approved by the AHJ
3 Local Jurisdiction and shall provide fire fighters with access
4 to any water connections, valves, or controls that are normally
5 secured by gates, doors, or other locking systems.

6 ~~(a) The hydrant or fire valve shall be eighteen (18) inches~~
7 ~~above the finished surface. Its location in relation to the road~~
8 ~~or driveway and to the Building(s) or structure(s) it serves~~
9 ~~shall comply with California Fire Code, California Code of~~
10 ~~Regulations title 24, part 9, Chapter 5, and Appendix C.~~

11 ~~(b) The hydrant head shall be a two and half (2 1/2) inch~~
12 ~~National Hose male thread with cap for pressure and gravity flow~~
13 ~~systems and four and a half (4 1/2) inch for draft systems.~~

14 ~~(c) Hydrants shall be wet or dry barrel and have suitable freeze~~
15 ~~or crash protection as required by the Local Jurisdiction.~~

16 Note: Authority cited: Section 4290, Public Resources Code.

17 Reference: Sections 4290 and 4291, Public Resources Code.

18
19 § 1275.04. Municipal-Type Water System Hydrants. Signing of
20 Water Sources

21 (a) The Municipal-Type Fire Hydrant valve stems and outlets
22 shall be eighteen (18) inches above the Finished Grade finished
23 surface. Its location in relation to the Road or Driveway and to
24 the Building(s) or structure(s) it serves shall comply with
25 California Fire Code, California Code of Regulations Title 24,

1 Part 9, Chapter 5, and Appendix C.

2 (b) The Municipal-Type Fire Hydrant shall be of sizes approved
3 designated by the AHJ-Local Jurisdiction, in consultation with
4 the Fire Authority, and shall have male American National Fire
5 Hose Screw Threads (NH).

6 (c) Where Municipal-Type water supply Fire Hydrant systems are
7 not practical due to the absence of a Municipal-Type Water
8 System, or other limiting factors, a performance-based water
9 supply alternative approved by the AHJ-Local Jurisdiction, in
10 consultation with the Fire Authority, shall be designed and
11 installed to meet the minimum fire flow water supply
12 requirements of 250 gallons per minute (gpm) for two (2) hours.

13 ~~(a) Each hydrant, fire valve, or access to water shall be~~
14 ~~identified as follows:~~

15 ~~(1) if located along a driveway, a reflectorized blue marker,~~
16 ~~with a minimum dimension of three (3) inches shall be located on~~
17 ~~the driveway address sign and mounted on a fire retardant post,~~
18 ~~or~~

19 ~~(2) if located along a road,~~

20 ~~(i) a reflectorized blue marker, with a minimum dimension of~~
21 ~~three (3) inches, shall be mounted on a fire retardant post. The~~
22 ~~sign post shall be within three (3) feet of said hydrant or fire~~
23 ~~valve, with the sign no less than three (3) feet nor greater~~
24 ~~than five (5) feet above ground, in a horizontal position and~~
25 ~~visible from the driveway, or~~

1 ~~(ii) as specified in the State Fire Marshal's Guidelines for~~
2 ~~Fire Hydrant Markings Along State Highways and Freeways, May~~
3 ~~1988.~~

4 Note: Authority cited: Section 4290, Public Resources Code.

5 Reference: Sections 4290 and 4291, Public Resources Code.

6
7 § 1275.05. Dry Hydrants

8 When dry hydrants have been approved by the **AHJ Local**
9 **Jurisdiction**, the requirements of NFPA 1142 (**2022**~~2017~~) Chapter 8
10 (8.3, 8.4, 8.5, 8.6, 8.7 and 8.8), hereby incorporated by
11 reference, shall be met.

12 Note: Authority cited: Section 4290, Public Resources Code.

13 Reference: Sections 4290 and 4291, Public Resources Code.

14
15 § 1275.06. Mobile Water Supply (Water Tenders)

16 (a) Fire **flow** water delivery systems that rely on mobile water
17 supply (water tenders) shall only be permitted under **either of**
18 the following conditions:

19 (1) During the construction phase of ~~a~~**new Building**
20 **Construction** ~~Development~~, prior to the permanent fire water
21 delivery system installation; or,

22 (2) **After the construction phase of a**~~new Building~~
23 **Construction**, ~~When~~ the Local Jurisdiction determines that all
24 other means of water supply is not practical.

25 (b) The mobile water supply shall, within five (5) minutes of

1 the arrival of the first Fire Apparatus on-scene, be capable of
2 providing the Fire Apparatus with a minimum of 250 gpm for a 2-
3 hour duration.

4 (c) Mobile water supplies may use NFPA 1142 (2022~~2017~~) Annex C,
5 hereby incorporated by reference, to achieve minimum fire flow
6 requirements.

7 Note: Authority cited: Section 4290, Public Resources Code.
8 Reference: Sections 4290 and 4291, Public Resources Code.

9
10 § 1275.07. Protection of Water Supply Infrastructure from
11 Wildfire.

12 (a) All water supply infrastructure shall be protected from
13 Wildfire radiant heat, convective heat, and embers by at least
14 one of the following:

15 (1) underground burial; or

16 (2) construction of non-combustible materials, fittings and
17 valves, such as concrete or metal; or

18 (3) maintenance of a 100-foot, ~~slope-adjusted~~ defensible
19 space immediately surrounding the infrastructure; or

20 (4) placement within a Building constructed to the
21 requirements of the California Building Code (California Code of
22 Regulations Title 24, Part 2) Chapter 7A.

23 Note: Authority cited: Section 4290, Public Resources Code.
24 Reference: Sections 4290 and 4291, Public Resources Code.

1 Article 5. Building Siting, Setbacks, and Fuel Modification ~~Fuel~~
2 ~~Modification Standards~~

3 § 1276.00. Applicability ~~Intent~~

4 (a) All Building ~~Construction~~ shall comply with the following
5 provisions of this Article:

6 (1) § 1276.01 (Building and Parcel Siting and Setbacks);

7 (2) § 1276.02(c) (Ridgelines); and

8 (3) § 1276.06 (Disposal of Flammable Vegetation and Fuels).

9 (b) The following provisions of this article shall further apply
10 in the tentative and parcel map process for ~~in~~ New parcels:

11 (1) § 1276.01 (Building and Parcel Siting and Setbacks);

12 (2) § 1276.02(c) (Ridgelines);

13 (3) § 1276.03 (Fuel Breaks);

14 (4) § 1276.04 (Greenbelts, Greenways, Open Spaces and
15 Parks);

16 (5) § 1276.05 (Maintenance of Fuel Breaks); and

17 (6) § 1276.06 (Disposal of Flammable Vegetation and Fuels).

18 ~~To reduce the intensity of a Wildfire by reducing the volume and~~
19 ~~density of flammable vegetation, the strategic siting of fuel~~
20 ~~modification and greenbelts shall provide for increased safety~~
21 ~~for emergency fire equipment and evacuating civilians by its~~
22 ~~utilization around structures and roads, including driveways,~~
23 ~~and a point of attack or defense from a Wildfire.~~

24 Note: Authority cited: Section 4290, Public Resources Code.

25 Reference: Sections 4290 and 4291, Public Resources Code.

1
2 § 1276.01. Building and Parcel Siting and Setbacks. ~~Setback for~~
3 ~~Structure Defensible Space~~

4 (a) All parcels shall provide a minimum thirty (30) foot setback
5 for all ~~B~~buildings from all property lines and/or the center of
6 a ~~R~~oad, except as provided for in subsection (b).

7 (b) A reduction in the minimum setback shall be based upon ~~When~~
8 ~~a thirty (30) foot setback is not possible for practical~~
9 ~~reasons, which may include but are not limited to, parcel~~
10 ~~dimensions or size; topographic limitations; ~~d~~Development~~
11 ~~density requirements or other ~~d~~Development patterns that promote~~
12 ~~low-carbon emission outcomes; sensitive habitat; or other site~~
13 ~~constraints~~ easements, and shall provide for an alternative
14 method to reduce Structure-to-Structure ignition by
15 incorporating features such as, but not limited to:

16 ~~Same practical effect options may include, but are not limited~~
17 ~~to:~~ (1) non-combustible block walls or fences; or

18 (2) five (5) feet of non-combustible material extending
19 five (5) feet horizontally from the furthest extent of the
20 Building; or

21 (3) installing hardscape landscaping or reducing a
22 reduction of exposed windows on the side of the ~~s~~Structure
23 with a less than thirty (30) foot setback; or

24 (4) the most protective ~~additional structure hardening that~~
25 ~~exceeds the~~ requirements in the California Building Code,

1 California Code of Regulations Title 24, Part 2, Chapter 7A, as
2 requested by the AHJ.

3 Note: Authority cited: Section 4290, Public Resources Code.

4 Reference: Sections 4290 and 4291, Public Resources Code.

5
6 § 1276.02. Ridgelines. Maintenance of Defensible Space Measures.

7 (a) The AHJ Local Jurisdiction shall identify ~~s~~Strategic
8 Ridgelines, if any, in consultation with the Fire Authority.

9 Strategic Ridgelines shall be identified through an assessment
10 of the following factors:

11 (1) Topography;

12 (2) Vegetation;

13 (3) Proximity to any existing or proposed residential,
14 commercial, or industrial land uses;

15 (4) Ability to support effective fire suppression; and

16 (5) Other factors, if any, deemed relevant by the AHJ Local
17 Jurisdiction and Fire Authority.

18 (b) Preservation of Undeveloped Ridgelines identified as
19 strategically important shall be required.

20 (c) New Buildings Residential Units on Undeveloped Ridgelines
21 identified as strategically important are prohibited, as
22 described in subsections (c)(1) and (c)(2).

23 (1) New Residential Units are prohibited within or at the
24 top of drainages or other topographic features common to
25 Ridgelines that act as chimneys to funnel convective heat from

1 Wildfires.

2 (2) Nothing in this subsection shall be construed to alter
3 the extent to which Structures, Buildings, or Development other
4 than Residential Units Buildings, such as but not limited to
5 Utility and Miscellaneous Group U Structures, may be constructed
6 on Undeveloped Ridgelines.

7 (d) The AHJ Local Jurisdiction may implement further specific
8 requirements to preserve Undeveloped Ridgelines.

9 ~~To ensure continued maintenance of commonly owned properties in
10 conformance with these standards and to assure continued
11 availability, access, and utilization of the defensible space
12 provided by these standards during a wildfire, provisions for
13 annual maintenance shall be provided in emergency access
14 covenants or similar binding agreements.~~

15 Note: Authority cited: Section 4290, Public Resources Code.

16 Reference: Sections 4290 and 4291, Public Resources Code.

17
18 § 1276.03. Fuel Breaks Disposal of Flammable Vegetation and
19 Fuels.

20 (a) When Building ~~e~~Construction meets the following criteria,
21 the AHJ Local Jurisdiction shall determine the need and location
22 for Fuel Breaks ~~in consultation with the Fire Authority:~~

23 (1) the permitting or approval of three (3) or more new
24 parcels, excluding lot line adjustments as specified in
25 Government Code (GC) section 66412(d); or

1 (2) an application for a change of zoning increasing zoning
2 intensity or density; or

3 (3) an application for a change in use permit increasing
4 use intensity or density.

5 (b) Fuel Breaks required by the AHJ Local Jurisdiction shall be
6 located, designed, and maintained in a condition that reduces
7 the potential of damaging radiant and convective heat or ember
8 exposure to Access routes, Buildings, or infrastructure within
9 the Development.

10 (c) Fuel Breaks shall have, at a minimum, one point of entry for
11 fire fighters and any Fire Apparatus. The specific number of
12 entry points and entry requirements shall be determined by the
13 AHJ.

14 (d) Fuel Breaks may be required at locations such as, but not
15 limited to:

16 (1) Directly adjacent to Defensible Space to reduce radiant
17 and convective heat exposure, ember impacts, or support fire
18 suppression tactics;

19 (2) Directly adjacent to Roads to manage radiant and
20 convective heat exposure or ember impacts, increase evacuation
21 safety, or support fire suppression tactics;

22 (3) Directly adjacent to a Hazardous Land Use to limit the
23 spread of fire from such uses, reduce radiant and convective
24 heat exposure, or support fire suppression tactics;

25 (4) Strategically located along Ridgelines, in Greenbelts,

1 or other locations to reduce radiant and convective heat
2 exposure, ember impacts, or support community level fire
3 suppression tactics.

4 ~~(ee)~~ Fuel Breaks shall be completed prior to the commencement of
5 any permitted construction.

6 ~~(ef)~~ Fuel Breaks shall be constructed using the most
7 ecologically and site appropriate treatment option, such as, but
8 not limited to, prescribed burning, manual treatment, mechanical
9 treatment, prescribed herbivory, and targeted ground application
10 of herbicides.

11 ~~(g)~~ Where an AHJ requires Fuel Breaks, maintenance mechanisms
12 shall be established to ensure the fire behavior objectives and
13 thresholds are maintained over time.

14 ~~(h)~~ The mechanisms required shall be binding upon the property
15 for which the Fuel Break is established, shall ensure adequate
16 maintenance levels, and may include written legal agreements;
17 permanent fees, taxes, or assessments; assessments through a
18 homeowners' association; or other funding mechanisms.

19 ~~(f) Fuel Breaks shall have, at a minimum, one point of entry for~~
20 ~~fire fighters and any Fire Apparatus. The specific number of~~
21 ~~entry points and entry requirements shall be determined by the~~
22 ~~Local Jurisdiction in consultation with the Fire Authority.~~

23 ~~Disposal, including chipping, burying, burning or removal to a~~
24 ~~site approved by the local jurisdiction, of flammable vegetation~~
25 ~~and fuels caused by site development and construction, road and~~

1 ~~driveway construction, and fuel modification shall be completed~~
2 ~~prior to completion of road construction or final inspection of~~
3 ~~a building permit.~~

4 Note: Authority cited: Section 4290, Public Resources Code.

5 Reference: Sections 4290 and 4291, Public Resources Code.

6
7 § 1276.04. Greenbelts, Greenways, Open Spaces and Parks

8 Greenbelts

9 (a) Where a Greenbelt, Greenway, open space, park, landscaped or
10 natural area, or portions thereof, is intended to serve as a
11 Fuel Break as part of a New Building Construction proposal, the
12 space or relevant portion thereof shall conform with the
13 requirements in [§ 1276.03 \(Fuel Breaks\)](#).

14 (b) An AHJ Local Jurisdiction may require Greenbelts or
15 Greenways, or portions thereof, or other open areas for the
16 purpose of providing potential areas of refuge for the public or
17 firefighters or other values as a last resort, if safe
18 evacuation is not practicable.

19 ~~Subdivision and other developments, which propose greenbelts as~~
20 ~~a part of the development plan, shall locate said greenbelts~~
21 ~~strategically as a separation between wildland fuels and~~
22 ~~structures. The locations shall be approved by the local~~
23 ~~authority having jurisdiction and may be consistent with the CAL~~
24 ~~FIRE Unit Fire Management Plan or Contract County Fire Plan.~~

25 Note: Authority cited: Section 4290, Public Resources Code.

1 Reference: Sections 4290 and 4291, Public Resources Code.

2
3 ~~§ 1276.05. Maintenance of Fuel Breaks~~

4 ~~(a) Where a Local Jurisdiction requires Fuel Breaks pursuant to~~
5 ~~§ 1276.03 (Fuel Breaks), maintenance mechanisms shall be~~
6 ~~established to ensure the fire behavior objectives and~~
7 ~~thresholds are maintained over time.~~

8 ~~(b) The mechanisms required shall be binding upon the property~~
9 ~~for which the Fuel Break is established, shall ensure adequate~~
10 ~~maintenance levels, and may include written legal agreements;~~
11 ~~permanent fees, taxes, or assessments; assessments through a~~
12 ~~homeowners' association; or other funding mechanisms.~~

13 ~~Note: Authority cited: Section 4290, Public Resources Code.~~

14 ~~Reference: Sections 4290 and 4291, Public Resources Code.~~

15
16 § 1276.065 Disposal of Flammable Vegetation and Fuels

17 The disposal, including burning or removal to a site approved by
18 the AHJ Local Jurisdiction, of flammable vegetation and fuels
19 caused by site development and construction, road and driveway
20 construction shall be in accordance with all applicable laws and
21 regulations.

22 Note: Authority cited: Section 4290, Public Resources Code.

23 Reference: Sections 4290 and 4291, Public Resources Code.



OFFICE OF THE CLERK
OF THE BOARD OF SUPERVISORS

REGULAR AGENDA REQUEST

Print

MEETING DATE January 18, 2022

Departments: Probation

TIME REQUIRED 15 minutes

SUBJECT Amendment to Deputy Probation
Officers MOU

**PERSONS
APPEARING
BEFORE THE
BOARD**

Karin Humiston, Chief Probation
Officer

AGENDA DESCRIPTION:

(A brief general description of what the Board will hear, discuss, consider, or act upon)

Proposed resolution amending the Memorandum of Understanding (MOU) between the County and the Deputy Probation Officers' Association to to add Special Assignment Pay for Officers providing Batterers' Intervention Services.

RECOMMENDED ACTION:

Adopt resolution amending MOU with Deputy Probation Officers Association to add a provision establishing five percent (5%) special assignment pay for up to three certified officers assigned as Batterers Intervention facilitators.

FISCAL IMPACT:

Fiscal impact for the proposed Probation MOU change to add five percent (5%) batterer's intervention enhanced pay, annually would be \$14,087 which includes \$10,103 for salary and \$3,984 for benefits. This assumes three officers qualify for the pay for an entire year. The additional costs would be funded by the SB 678 revenues. No fiscal impact to the general fund.

CONTACT NAME: Karin Humiston

PHONE/EMAIL: 7609325572 / jlmills@mono.ca.gov

SEND COPIES TO:

MINUTE ORDER REQUESTED:

YES NO

ATTACHMENTS:

Click to download
<input type="checkbox"/> Staff Report
<input type="checkbox"/> Resolution
<input type="checkbox"/> Cost Analysis

History

Time	Who	Approval
1/10/2022 12:40 PM	County Counsel	Yes
1/13/2022 12:51 PM	Finance	Yes
1/14/2022 3:14 PM	County Administrative Office	Yes



MAILING: P.O. BOX 596, BRIDGEPORT, CALIFORNIA 93517
BRIDGEPORT OFFICE (760) 932-5570•FAX (760) 932-5571
MAMMOTH OFFICE (760) 924-1730•FAX (760) 924-1731

probation@mono.ca.gov

Mark Magit
Presiding Judge
Superior Court

Dr. Karin Humiston
Chief Probation Officer

Date: December 28, 2021
To: Honorable Board of Supervisors
From: Karin Humiston, Chief of Probation
Subject: Amendment to Mono County Probation Officers Association MOU

Recommended Action:

Approve amendment to Mono County Probation Officers Association Memorandum of Understanding, Article 30 Special Assignment Pay adding five percent (5%) additional pay for three certified officers assigned as Batterers Intervention facilitators.

Discussion:

Batterers Intervention is a court mandated 52-week program. Pursuant to 1203.097(c)(5), the *probation department shall have the sole authority to approve a batterer's intervention program for probation.*

The certification process for the three officers was complex and expensive. It was a non-Standards and Training for Corrections, but Penal Code 1203.097 and 1203.098 mandatory training. What may have looked like 40 hours on their certification took almost 4 months for each officer to complete due to readings, homework and meetings with the psychologist who provided the training and certification. There was a major investment in this program. All three officers currently participate in session debriefings for the clients currently enrolled. Probation and non-probation clients will be given a choice between Behavioral Health's or Probation's Batterers Intervention program regardless of where they live. I expect to see a client base increase for probation given

most of our clients cannot afford the \$1410 cost imposed by the Behavioral Health program. In alignment with California's direction under AB 1869 to eliminate criminal fees, probation would ask the participant to reimburse only for the cost of the book, which is \$50. If they are indigent, probation would waive that charge.

We are receiving inquiries from other probation departments interested in expanding their program offerings to include Batterers Intervention. Their reasoning is various but given the direction of this state and probation philosophy, I would not be surprised to see this change increase with probation offering Batterers Intervention services rather than behavioral health or contracted agencies.

I believe all three officers should receive the five percent (5%) as soon as Article 30 is amended. The far-reaching impact their facilitation will have on the reduction of victims and violent crime, seems to be a wise investment by the county for its citizens.

Fiscal Impact

The estimated fiscal impact for the proposed Probation MOU change to add five percent (5%) batterer's intervention enhanced pay, annually would be \$14,087 which includes \$10,103 for salary and \$3,984 for benefits. This assumes the three officers qualify for the pay for an entire year. The additional costs would be funded by the SB 678 revenues.

No fiscal impact to the general fund.

Attachments:

Cost Analysis.



R22-__

A RESOLUTION OF THE MONO COUNTY BOARD OF SUPERVISORS AMENDING THE MEMORANDUM OF UNDERSTANDING WITH THE DEPUTY PROBATION OFFICERS ASSOCIATION TO ADD SPECIAL ASSIGNMENT PAY FOR OFFICERS PROVIDING BATTERERS' INTERVENTION SERVICES

WHEREAS, a Memorandum of Understanding between the County of Mono and the Mono County Probation Officers Association is in effect for the term July 1, 2019 until June 30, 2023 (the "MOU"); and

WHEREAS, batterer's intervention is a court mandated 52-week program. Pursuant to Penal Code section 1203.097(c)(5), the Superior Court and/or County Probation Department must refer qualified individuals to a batterer's intervention program; and

WHEREAS, the Mono County Probation Department has trained and certified three Deputy Probation Officers as Batterers' Intervention Facilitators; and

WHEREAS, the Board of Supervisors wishes to amend Article 30 of the MOU "Special Assignment Pay" to add a provision authorizing five percent (5%) special assignment pay for up to three Deputy Probation Officers providing batterers' intervention services;

NOW, THEREFORE, THE MONO COUNTY BOARD OF SUPERVISORS DOES HEREBY RESOLVE that the following language is added to Article 30 of the Memorandum of Understanding between the Deputy Probation Officers Association and the County of Mono:

"Up to three (3) Deputy Probation Officers assigned as Batterer's Intervention facilitators shall receive an additional five percent (5%) of their Base Rate of Pay."

PASSED, APPROVED and ADOPTED this _____ day of _____, 2022, by the following vote, to wit:

AYES:

NOES:

ABSENT:

ABSTAIN:

Bob Gardner, Chair
Mono County Board of Supervisors

ATTEST:

APPROVED AS TO FORM:

Clerk of the Board

Mono County Counsel

1
2
3
4
5
6
7
8
9
10
11
12
13
14
15
16
17
18
19
20
21
22
23
24
25
26
27
28
29
30
31
32
33

Employee:		Pay Period Salary + Additional Pay			Benefits & Taxes	Health Benefits	Annual Benefits + Taxes	Total Salary & Benefits/Taxes	Total Salary & Benefits/Taxes + Health Benefits	Annual Total Salary + Benefits
Last Name	First Name	Base Salary	Additional Pay	Total Pay						
Barkley	Jazmin	\$ 3,311.42	\$ 163.85	\$ 3,475.27	\$ 1,177.03	\$ 1,796.95	\$	4,652.30	\$ 6,449.25	
		\$ 86,097.00	\$ 4,260.00	\$ 90,357.00	\$ 30,602.84	\$ 23,360.35	\$ 53,963.19	\$ 60,479.92	\$ 83,840.27	\$ 144,320.19
Mejia	Orlando	\$ 123.26	\$ -	\$ 123.26	\$ 47.02	\$ 5.12	\$	170.28	\$ 175.40	
		\$ 3,204.70	\$ -	\$ 3,204.70	\$ 1,222.63	\$ 66.56	\$ 1,289.19	\$ 2,213.66	\$ 2,280.22	\$ 4,493.89
Flores	Alastair	\$ 2,465.15	\$ 163.85	\$ 2,629.00	\$ 658.05	\$ 1,133.34	\$	3,287.05	\$ 4,420.39	
		\$ 64,094.00	\$ 4,260.00	\$ 68,354.00	\$ 17,109.39	\$ 14,733.42	\$ 31,842.81	\$ 42,731.69	\$ 57,465.11	\$ 100,196.81
Hill	Curtis	\$ 2,537.60	\$ 106.15	\$ 2,643.75	\$ 892.02	\$ 2,278.29	\$	3,535.78	\$ 5,814.07	
		\$ 65,977.60	\$ 2,760.00	\$ 68,737.60	\$ 23,192.57	\$ 29,617.77	\$ 52,810.34	\$ 45,965.09	\$ 75,582.86	\$ 121,547.94
Himmelhoch	Jon	\$ 2,857.12	\$ 48.46	\$ 2,902.19	\$ 980.60	\$ 1,792.39	\$	3,882.80	\$ 5,675.19	
		\$ 74,285.12	\$ 1,260.00	\$ 75,545.12	\$ 25,495.71	\$ 23,301.07	\$ 48,796.78	\$ 50,476.36	\$ 73,777.43	\$ 124,253.78
Knight	Erin	\$ 2,342.19	\$ 200.70	\$ 2,542.90	\$ 737.21	\$ 1,720.72	\$	3,280.11	\$ 5,000.83	
		\$ 60,897.00	\$ 5,218.31	\$ 66,115.31	\$ 19,167.49	\$ 22,369.36	\$ 41,536.85	\$ 42,641.40	\$ 65,010.76	\$ 107,652.16
Mills	Jeff	\$ -	\$ 48.46	\$ 48.46	\$ 737.21	\$ 5.93	\$	785.67	\$ 791.60	
		\$ -	\$ 1,260.00	\$ 1,260.00	\$ 19,167.49	\$ 77.09	\$ 19,244.58	\$ 10,213.75	\$ 10,290.84	\$ 20,504.58
VanKampen	Erin	\$ 2,853.73	\$ 48.46	\$ 2,902.19	\$ 1,080.83	\$ 5.12	\$	3,983.02	\$ 3,988.14	
		\$ 74,197.00	\$ 1,260.00	\$ 75,457.00	\$ 28,101.59	\$ 66.56	\$ 28,168.15	\$ 51,779.29	\$ 51,845.85	\$ 103,625.15
Wagner	Amanda	\$ 129.42	\$ 48.46	\$ 48.46	\$ 2.46	\$ 5.93	\$	50.92	\$ 56.85	
		\$ 3,364.95	\$ 1,260.00	\$ 4,624.95	\$ 63.95	\$ 77.09	\$ 141.04	\$ 661.98	\$ 739.07	\$ 1,401.04
Whitmore	Dylan	\$ 3,153.73	\$ 48.46	\$ 2,902.19	\$ 1,080.83	\$ 1,869.76	\$	3,983.02	\$ 5,852.78	
		\$ 81,997.00	\$ 1,260.00	\$ 83,257.00	\$ 28,101.59	\$ 24,306.88	\$ 52,408.47	\$ 51,779.29	\$ 76,086.17	\$ 127,865.47
Daley	Leianna	\$ 135.89	\$ -	\$ -	\$ 51.75	\$ -	\$	51.75	\$ 51.75	
		\$ 3,533.00	\$ -	\$ 3,533.00	\$ 1,345.46	\$ -	\$ 1,345.46	\$ 672.73	\$ 672.73	\$ 1,345.46



**OFFICE OF THE CLERK
OF THE BOARD OF SUPERVISORS**

REGULAR AGENDA REQUEST

Print

MEETING DATE January 18, 2022

Departments: CAO

TIME REQUIRED 15 minutes

PERSONS APPEARING BEFORE THE BOARD Robert C. Lawton

SUBJECT Request for Letter of Commitment for Project Homekey Grant Application for Mammoth Lakes Housing

AGENDA DESCRIPTION:

(A brief general description of what the Board will hear, discuss, consider, or act upon)

Request for a letter of commitment to a Project Homekey grant application for Mammoth Lakes Housing to the State of California. If successful, this project will result in the creation of 14 housing units in Mammoth Lakes, to be owned and operated by Mammoth Lakes Housing. The grant application requires up to a \$1.2m in a local match, currently anticipated as up to a \$700,000 contribution from the Town of Mammoth Lakes and this request for a commitment of up to a \$500,000 contribution from the County.

RECOMMENDED ACTION:

Board Decision. Provide any desired direction to staff.

FISCAL IMPACT:

Mammoth Lakes Housing is requesting a commitment of up to \$500,000 to combine with up to \$700,000 from the Town of Mammoth Lakes for a total of up to \$1,200,000 in local funding to be matched by the State on a one-to-one basis.

CONTACT NAME: Robert C. Lawton

PHONE/EMAIL: 760-932-5415 / rlawton@mono.ca.gov

SEND COPIES TO:

MINUTE ORDER REQUESTED:

YES NO

ATTACHMENTS:

<p>Click to download</p> <p> Sample Commitment Letter</p>

History

Time

Who

Approval

1/14/2022 3:16 PM	County Counsel	Yes
1/14/2022 3:16 PM	Finance	Yes
1/14/2022 3:17 PM	County Administrative Office	Yes

January 18, 2022

State of California
Department of Housing & Community Development
2020 W. El Camino Ave., Suite 500
Sacramento, CA 95833

RE: PROJECT HOMEKEY APPLICATION – LOCAL MATCH COMMITMENT

Project Address
Mammoth Lakes, CA 93546
APN: XXXXX

To Whom It May Concern:

Mammoth Lakes Housing, a certified Community Housing Development Organization, is applying for funding under the Project Homekey program for the conversion of an existing hotel into approximately 15 studio, affordable apartments.

Mono County, in support of this project, is committing the following permanent sources of funding to assist with the completion of this critical project, as directed by the Board of Supervisors at their January 18, 2022 meeting.

NAME OF SOURCE: Up to \$500,000
Borrower Name: Mammoth Lakes Housing, Inc.
Project: NAME
ADDRESS
APN
Interest Rate: 0%
Term: Permanent, Grant, No Repayment Required

This financial commitment is an interest-free, cash, grant investment to support affordable community housing.

If you have any questions regarding these funds, please do not hesitate to contact me at (760)-932-5415 or by email at RLawton@mono.ca.gov.

Sincerely,

Robert Lawton
County Administrative Officer



**OFFICE OF THE CLERK
OF THE BOARD OF SUPERVISORS**

REGULAR AGENDA REQUEST

Print

MEETING DATE January 18, 2022

TIME REQUIRED

SUBJECT Closed Session - Labor Negotiations

**PERSONS
APPEARING
BEFORE THE
BOARD**

AGENDA DESCRIPTION:

(A brief general description of what the Board will hear, discuss, consider, or act upon)

CONFERENCE WITH LABOR NEGOTIATORS. Government Code Section 54957.6. Agency designated representative(s): Bob Lawton, Stacey Simon, Janet Dutcher, Anne Frievalt, Ryan Roe, and Oliver Yee. Employee Organization(s): Mono County Sheriff's Officers Association (aka Deputy Sheriff's Association), Local 39 - majority representative of Mono County Public Employees (MCPE) and Deputy Probation Officers Unit (DPOU), Mono County Paramedic Rescue Association (PARA), Mono County Public Safety Officers Association (PSO). Unrepresented employees: All.

RECOMMENDED ACTION:

FISCAL IMPACT:

CONTACT NAME:

PHONE/EMAIL: /

SEND COPIES TO:

MINUTE ORDER REQUESTED:

YES NO

ATTACHMENTS:

<p>Click to download</p> <p>No Attachments Available</p>
--

History

Time

Who

Approval



**OFFICE OF THE CLERK
OF THE BOARD OF SUPERVISORS**

REGULAR AGENDA REQUEST

Print

MEETING DATE January 18, 2022

TIME REQUIRED

SUBJECT Closed Session - Existing Litigation

**PERSONS
APPEARING
BEFORE THE
BOARD**

AGENDA DESCRIPTION:

(A brief general description of what the Board will hear, discuss, consider, or act upon)

CONFERENCE WITH LEGAL COUNSEL – EXISTING LITIGATION. Paragraph (1) of subdivision (d) of Government Code section 54956.9. Name of case: *Shroeder Muniz v. County of Mono et al.* (DFEH Case No. 202108-14595527).

RECOMMENDED ACTION:

FISCAL IMPACT:

CONTACT NAME:

PHONE/EMAIL: /

SEND COPIES TO:

MINUTE ORDER REQUESTED:

YES NO

ATTACHMENTS:

<p>Click to download</p> <p>No Attachments Available</p>
--

History

Time	Who	Approval
1/10/2022 11:45 AM	County Counsel	Yes
1/6/2022 4:37 PM	Finance	Yes
1/14/2022 3:15 PM	County Administrative Office	Yes



OFFICE OF THE CLERK
OF THE BOARD OF SUPERVISORS

REGULAR AGENDA REQUEST

Print

MEETING DATE January 18, 2022

TIME REQUIRED

SUBJECT Closed Session - Public Employee
Evaluation

**PERSONS
APPEARING
BEFORE THE
BOARD**

AGENDA DESCRIPTION:

(A brief general description of what the Board will hear, discuss, consider, or act upon)

PUBLIC EMPLOYEE PERFORMANCE EVALUATION. Government Code section 54957. Title: County Administrative Officer.

RECOMMENDED ACTION:

FISCAL IMPACT:

CONTACT NAME:

PHONE/EMAIL: /

SEND COPIES TO:

MINUTE ORDER REQUESTED:

YES NO

ATTACHMENTS:

[Click to download](#)

No Attachments Available

History

Time

Who

Approval